



Centork electric actuators 462 to 464 and 472 to 474 series



*Installation and maintenance
User manual*

THIS USER MANUAL HAS BEEN DEVELOPED FOR centork ELECTRIC ACTUATORS 462, 472, 463, 473, 464 AND 474 SERIES WITH CENTRONIK UNIT



CAUTION

centork Electric actuators are high value devices. In order to prevent damage in their handling, setting and use it is essential to follow and observe all the points in this user manual, operate under actuators' designated use, and observe health and safety rules, standards and directives, as other national regulations as well.

centork Electric actuators must be handled with care and caution.

IMPORTANT NOTE

This work and the information it contains are property of CENTORK Valve Control S.L.. The information it contains will not be reproduced or disclosed, in whole or in part, without the prior written consent of CENTORK.

The contents in this manual are subject to change due to the quality improvement without individual notice.

Index

1	CENTORK ELECTRIC ACTUATORS: INTRODUCTION	7
2	SAFETY INSTRUCTIONS.....	7
3	TRANSPORT AND STORAGE	8
3.1	Transport.....	8
3.2	Storage and commissioning.....	8
3.2.1	Commissioning	8
3.2.2	Storage	9
4	CONDITIONS OF SERVICE FOR ELECTRIC ACTUATORS	10
4.1	Electric actuator: Main description and purpose.....	10
4.2	Operation modes: OFF, LOCAL and REMOTE mode.....	10
4.2.1	OFF mode.....	10
4.2.2	LOCAL mode.....	10
4.2.3	REMOTE mode.....	11
4.2.4	Program mode	11
4.3	Actuator and motor duty service	12
4.4	Temperature range	12
4.5	IP protection degree.....	12
4.6	Painting and protection against corrosion.....	12
4.7	Centronik types: Identification	13
4.8	Features of the electronic switching and signaling unit	13
4.8.1	Local indication:	13
4.8.2	Position control:	14
4.8.3	Torque Control:	14
4.8.4	Motor thermal protection:.....	14
4.8.5	Output signal relays:.....	14
4.8.6	Position and torque analogue transmitters TPS and TTS (Optional):	14
5	MOUNTING TO THE VALVE	15
5.1	Pre-Installation Inspection.....	15
5.2	Output size	15
5.3	Output type.....	15
5.4	Mounting.....	15
5.5	Centronik unit frontal panel orientation	16
5.6	Electronic switching and signalling unit frontal panel orientation.....	16
6	ELECTRICAL CONNECTIONS	17
6.1	Wiring diagram (electric manoeuvre).....	17
6.1.1	Duty service	17
6.1.1.1	ON/OFF duty.....	17
6.1.1.2	Modulating duty.....	17
6.1.1.3	ON/OFF duty with position.....	17
6.1.2	Components.....	18
6.1.2.1	Voltage supply.....	18
6.1.2.2	Digital outputs	18
6.1.2.3	Relay outputs	18
6.1.2.4	Position transmitter TPS	19
6.1.2.5	Torque transmitter TTS.....	19
6.1.2.6	Capacitors	19
6.1.2.7	Field bus.....	19

6.1.2.8	Other elements	20
6.2	Terminal plan and wiring	20
6.3	Cable installation in accordance with EMC	21
6.4	Centronik unit on wall bracket (as option)	22
7	MANUAL OPERATION	23
8	LOCAL MODE: CONTROL AND DISPLAYS ELEMENTS	24
8.1	Lockable selector	24
8.2	Push-buttons	25
8.3	Centronik LED indications	25
9	ELECTRONIC SWITCHING AND SIGNALING UNIT	26
9.1	Data and features of the electronic switching and signalling unit	26
9.2	LED indication	26
9.2.1	Local and remote operation modes:	26
9.2.2	Setting mode;	26
9.3	Local pushbuttons of the electronic switching and signalling unit.....	27
9.4	LCD screen.....	27
9.5	Battery of the electronic switching and signalling unit.....	27
9.5.1	External power supply operation mode.....	28
9.5.2	Low energy operation mode	28
10	SETTINGS AND PRELIMINARY TESTS (START-UP).....	30
10.1	DIP-SWITCHES configuration.....	31
10.1.1	Operation mode	31
10.1.2	Centronik output signals configuration (Only in ON/OFF duty)	31
10.1.3	Actuator and valve (Sense of rotation)	32
10.1.4	Posicion transmitter range	32
10.1.5	Remote mode selection	32
10.2	Settings of the electronic switching and signalling unit	33
10.2.1	Settings screen (N°1 screen).....	33
10.2.1.1	Set of Open position 0% -Fully closed position- (1.1 screen).....	34
10.2.1.2	Set of Open position 100% -Fully open position- (1.2 screen)	34
10.2.1.3	Set of Open torque value (1.3 screen).....	35
10.2.1.4	Set of Close torque value (1.4 screen)	35
10.2.1.5	Alarms setting (1.5 screen).....	36
10.2.1.6	Electronic position transmitter TPS setting (1.6 screen).....	37
10.2.1.7	Electronic torque transmitter TTS setting (1.7 screen)	37
10.2.1.8	Relays setting (1.8 screen)	38
10.2.1.9	Language setting (1.9 screen)	39
10.2.1.10	New password (1.10 screen)	40
10.2.1.11	Reset system (1.11 screen)	40
10.2.1.12	Activate battery (1.12 screen).....	40
10.2.1.13	Deactivate battery (1.13 screen).....	41
10.2.1.14	Firmware Version and LCD Contrast (1.14 screen).....	41
10.2.2	Actuator serial number screen (N°2 screen)	41
10.2.3	Datalogger: Operational data screen (N°3 screen)	42
10.2.4	Outputs (N°4 screen)	42
10.2.5	Torque and position screens (N°5, N°6 and N°7 screens)	42
10.3	CENTRONIK setting procedure (only Modulating and On-Off with display units)	44
10.3.1	Access to program mode – Password	45
10.3.2	Control input signal (only in Modulating duty).....	45
10.3.3	Polarity (only in Modulating duty)	46
10.3.4	Zero and span for Control input and TPS –feedback signal- (only in Modulating duty).....	46
10.3.5	Outputs signals (Digital or relays outputs).....	48

10.3.6	Rest time	48
10.3.7	Valve opening curves (only in Modulating duty).....	49
10.3.8	Operation mode ESD (only in Modulating duty and ON/OFF duty with position display)	50
10.3.9	Deadband (only in Modulating duty).....	50
10.3.10	Autolearn (only in Modulating duty).....	51
10.3.11	Close tightly (only in Modulating duty).....	51
10.3.12	Blinker (only in Modulating duty and ON/OFF duty with position display)	52
10.3.13	Calibration of the CENTRONIK unit	52
10.3.14	Inching mode (only in ON/OFF duty with position display)	52
10.3.15	Stepping mode (only in ON/OFF duty with position display))	53
10.3.16	Centronik data logging	55
10.3.17	New Password.....	55
11	TROUBLE SHOOTING.....	56
11.1	Front panel indication fault	56
11.2	Actuator does not operate in LOCAL mode	57
11.3	Actuator does not operate correctly in REMOTE mode.....	57
11.4	Actuator turn in the wrong sense	57
11.5	Centronik output signals does not work	57
12	MAINTENANCE.....	58
12.1	Commissioning, after the star-up	58
12.2	Maintenance for service	58
12.3	Electric actuator's service life.....	58
12.4	Centronik fuses replacement	59
12.5	Replacement of the electronic switching and signalling battery	60
13	TECHNICAL SUPPORT	61
14	LIST OF SPARE PARTS	62
14.1	Actuator unit	62
14.2	Centronik unit	63

1 CENTORK ELECTRIC ACTUATORS: INTRODUCTION

The electric actuator is a device designed to be coupled to a general-purpose industrial valve, to carry out its movement. The movement is stopped by limit switching or by torque (thrust) switching.

Other applications should be consulted CENTORK before. CENTORK is not liable for any possible damages resulting from use in other than designated applications. Such risk lies entirely on the user.

2 SAFETY INSTRUCTIONS

The scope of this manual is to enable a competent user to install, operate, adjust and inspect a CENTORK electric actuator. These instructions must be observed, otherwise a safe operation of the actuator in no longer warrantee.

When handling electric equipment, the health and safety standards (EN 60.204, 73/23/EEC directives) and any other national legislation applicable must be observed.



As electric device, during electrical operation certain parts inevitably carry lethal voltages and currents (ELECTRICAL RISKS).

Works on the electrical system or equipment must only be carried out by a skilled electrician himself or by specially instructed personnel, in accordance with the applicable electrical engineering rules, health and safety Directives and any other national legislation applicable.

Electric actuators are powerful apparatus. A negligence handling might cause severe damages to valves, people, and actuator as well. Under no circumstances should any modification or alteration be carried out on the actuator as this could very well invalidate the conditions which the device was designed.



Under operation, motor enclosure surfaces can reach high temperatures (up to 100°C). Protection measures should be taken into account in order to prevent people and goods from it.



3 TRANSPORT AND STORAGE

3.1 Transport

- **CENTORK electric actuators must be transported in sturdy packing.** During transport measures should be adopted in order to prevent impacts, hits. CENTORK delivers its actuators ex-work.
- **For transport purposes, handwheels are supplied separately.**
- **Hits or impacts against wall, surfaces or objects might cause severe damage on Electric actuator.** In these cases, after such events, a technical inspection must be done by CENTORK technicians.
- **Do not attach to the handwheel ropes or hooks to lift by hoist.**
- The valve-actuator unit cannot be lifted/manipulated employing any lifting point of the actuator; Actuator has been designed and sized in order to motorize industrial valves, and withstand the forces and torque required.
- **Covers have to be properly closed (Tight) and sealed. Cable entries on electrical connection cover must be sealed. Protection plug supplied by CENTORK are only adequate for storing in dry and ventilated places, for short period of time. In other conditions protection plug must be replaced with metallic plug sealed with PTFE tape.**
- Each Actuator is delivered with a set of technical documentation (User manual, datasheet, diagrams...), which has to be carefully stored.



3.2 Storage and commissioning

Despite of their high degree of protection (IP67 as standard, and IP68 optional) condensation – presence of water- can occur inside the electric actuators by incorrect and negligent handling of the actuators. This may damage sensitive internal parts during the storage. This problem can be avoided by observing the following points.

3.2.1 Commissioning

- Verify the actuator to insure correct model number, torque, operating speed, options and special components, voltage and enclosure type, and the actuator control before installation or use. It is important to verify that the actuator is appropriate for the requirements of the valve and the intended application. If there is any discrepancy, please contact with your local distributor, or CENTORK, to solve that discrepancy. Once the electric actuator has been set up, CENTORK decline any responsibility related to discrepancies.
- Check (Visual inspection) in order to detect possible damages caused during transport or storage. **Checking should include a visual inspection of electric compartment, and switching and signalling unit compartment.**
- Check that the painting work of the actuator is not been damaged. Retouch it when damaged.
- **Check that electrical connection cover, centronik frontal panel and switching and signalling unit cover and are correctly closed and tight. Cable entries on electrical connection cover must be sealed. Protection plug supplied by CENTORK are only adequate for storing in dry and ventilated places, for short period of time. In other conditions protection plug must be replaced with metallic plug sealed with PTFE tape.**
- Each Actuator is delivered with a set of technical documentation (User manual, datasheet, diagrams...), which has to be carefully stored.
- If damages like shocks, cracks, hits or others due to an improper handling, or humidity inside the equipment due to improper storage appear, contact CENTORK or your nearest distributor.



3.2.2 Storage



- **Store in a clean, cool, dry and ventilated place. Protect against humidity from the floor. Use pallets, wooden frames, cage boxes or shelves.**

- Check that electrical connection cover and switching and signalling unit cover and are correctly closed and tight.



- **Cable entries on electrical connection cover must be sealed. Protection plug supplied by CENTORK are only adequate for storing in dry and ventilated places, for short period of time. In other conditions protection plug must be replaced with metallic plug sealed with PTFE tape.**



- Do not store the actuator directly on the ground!
- Cover it to protect it from dust and dirt. Cover the machined parts with suitable protection against corrosion. **Do not employ plastic bags, as they can cause condensation.**
- Each Actuator is delivered with a set of technical documentation (User manual, datasheet, diagrams...), which has to be carefully stored.
- **For other storage conditions or, and long time periods (More than 5 months) contact to manufacturer.**

4 CONDITIONS OF SERVICE FOR ELECTRIC ACTUATORS

4.1 Electric actuator: Main description and purpose

- Electric actuator is an apparatus or device formed by an electric motor, coupled to a main gearbox unit, which transmits motion and torque to valves. An electronic switching and signalling unit manages the valve position and torque/thrust applied.
- Power supply and controls elements (transformer, relays, leds, electronic boards...) are included in the Centronik unit. Centronik unit has CPU microprocessor and electronic boards: Electric actuator is operated and controlled by means of these electronic and electric device of the centronik unit, being supplied with main power.
- Electric actuator can be controlled in LOCAL mode by mean of pushbuttons located in the centronik front panel or in REMOTE mode with remote controls such us SCADA, PLC, or a MASTER STATION by mean of a FIELDBUS (Optional)
- Electric actuators are provided with a declutchable manual override system in order to operate manually in case of emergency or fail of power supply.
- Electric actuator can be coupled directly to valve, or maybe, through gearbox units (Bevel, spur and worm gearboxes).
- The electric actuator is a device designed to be coupled to a general-purpose industrial valve, to carry out its movement. The movement is stopped by limit switching or by torque (thrust) switching. Other applications should be consulted CENTORK before. **CENTORK is not liable for any possible damages resulting from use in other than designated applications. Such risk lies entirely on the user.**

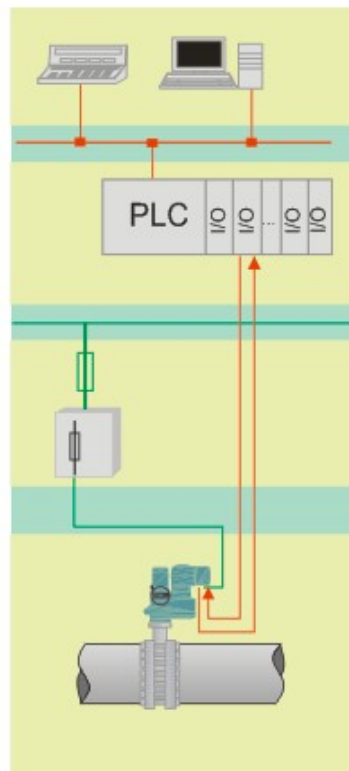

4.2 Operation modes: OFF, LOCAL and REMOTE mode

Electric actuator can be controlled/operated from the control station (REMOTE mode) and at the local control (LOCAL mode). Centronik unit is equipped with local pushbuttons and display. The lockable selector switch LOCAL/OFF/REMOTE allows the operation mode to be set.

4.2.1 OFF mode.

- In this operation mode, the actuator remains connected and powered but it does not responds to any order (Open, close or stop) from the front panel or from the remote control. The front panel control indicates only the power supply status (Led 5).

4.2.2 LOCAL mode.

- By mean of push buttons OPEN-CLOSE-STOP located on the centronik front panel, the actuator can be operated locally. 5 indication lights (LEDs) show the actuator status from the centronik front panel (See 8.3 chapter).
- Push buttons are **self-retaining** type: Once the push button has been pressed, its order or action is generated, and it remains "active" until a new order or command is generated, or any operation event takes place such us a limit switch or torque switch signal, an anomaly case or any centronik function or event. It is NOT necessary to keep "pressing" the pushbutton.

4.2.3 REMOTE mode.

Electric actuator with ON/OFF duty control:

- Electric actuator can be controlled/operated from the control station (REMOTE, via the Fieldbus) with the commands OPEN-CLOSE-STOP (**self-retaining** type) or OPEN-CLOSE (“push to run” operation) as option.
- ON/OFF duty control means open loop control.
- With **self-retaining operation**, the actuator continues to run as long as the STOP command from the control system (digital input, see 6.1.1.1 chapter) is not being generated, or any centronik operation condition takes place.
- With **“push to run” operation** (Inching mode) the actuator continues to run as long as this command from the control system remains. It is necessary to keep “pressing” the pushbutton or maintaining the remote input signal.
- TPS Electronic position transmitter (0-4/20mA, 0-2/10V or resistive value) can be employed, as option, which in order to provide the real valve position indication.

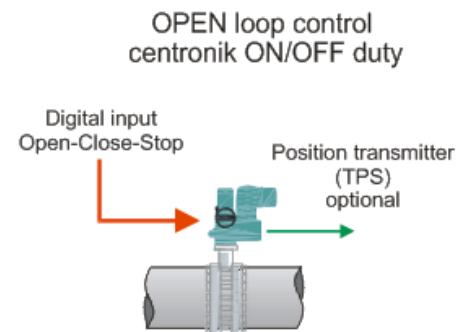

Electric actuator with modulating duty control:

- Electric actuator is equipped with an electronic integral positioner that automatically positions the valve in accordance with the analogue input control signal (0-4/20mA current signal and voltage signal as option) coming from the control station (REMOTE).
- Modulating duty control means close loop control. The modulating duty control registers and compares the analogue input control and the actual position value (Feedback signal given by TPS actuator position transmitter). The electric actuator runs to OPEN or CLOSE direction, according to the deviation detected.
- The modulating behaviour is stabilised by determining inner (internal) and outer (external) deadbands, rest time and therefore the wear of valve and actuator can be reduced. See 10.3 chapter for parameters setting of the modulating centronik unit.

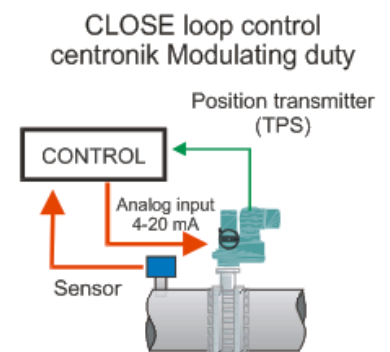

Electric actuator with ON/OFF duty control with position display:

- This mode is has an ON/OFF duty control but with some advance and upgrade functions:
 - Some parameters can be configured via the centronik frontal panel.
 - Frontal panel has a continuous valve position display.
 - Some different operation modes can be programmed or set.
 - The feedback valve position indication given by actuator TPS electronic transmitter.

4.2.4 Program mode

- For **on-off with display** and **modulating** duties centronik units, by mean of the program mode it is possible to select and configured the centronik parameters, functions and features (See 10.3 chapter)
- In order to access to this mode, it is necessary to switch the centronik selector in LOCAL mode and introduce the correct PASSWORD (See 0 chapter)

4.3 Actuator and motor duty service

Electric actuator has been designed for valve motorization, which requires ON-OFF or modulating duty service.

- **ON-OFF duty service:** Electric actuator has been designed as S2-15 min (Three phases motor) or S2-10 min (Single phases motors) duty cycle at nominal torque, according to IEC 60034 standards: Nominal torque is rated to 50% of max tripping torque (100%), value marked on actuator nameplates. Higher nominal torques can reduce the actuator's service life and S2 duty cycle.
- **Modulating duty service:** Electric actuators have been designed as S4-25% according to IEC 60034, at 1.200-800 starts per hour, at nominal torque. Nominal torque is rated to 50% of max tripping torque (100%), value marked on actuator nameplates. Higher nominal torques can reduce the actuator's service life and S4 duty cycle conditions.

4.4 Temperature range

CENTORK Electric actuators work in a temperature range from -25°C to +70°C.

For other temperature range, consult CENTORK.

4.5 IP protection degree

- CENTORK Electric actuators are designed in their standard version with IP67 (According to EN 60.529) environmental protection although IP68 protection may be supplied on request (Option).
- **IP67 and IP68 protection degree is only guarantee employing proper protection plug and cable gland (For cable entries)**, according to IP degree (See 6 Chapter).
- It is necessary to observe storing and maintenance rules written on TRANSPORT AND STORAGE as well (Chapter 3).

4.6 Painting and protection against corrosion

- CENTORK has designed three protections degree: Standard protection, P1 and P2. For technical details, consult CENTORK technical datasheets. Other processes are possible, under request.
- CENTORK standard protection: Electric actuators are coated with an epoxy- two components primer (Film thickness depends on protection class selected, actuators are coated with intermediates primers) followed by a polyurethane component paint coat. The standard colour is blue RAL 5.003. Other colours are possible (Option). Other film thickness under request.

4.7 Centronik types: Identification

- The followings data are defined on the Centronik nameplates.
- As standard, there are 3 types of control of centronik unit:
 - **On-off** control centronik unit
 - **Modulating** control centronik unit
 - **ON-Off** with display control centronik unit.

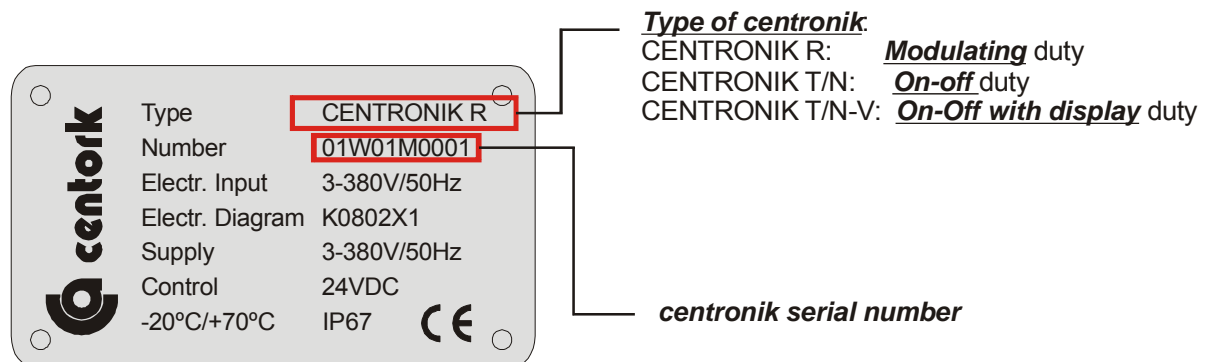

- The type of centronik (Control) is indicated and marked in the centronik nameplates, and it is described also in the CENTORK acknowledgment order
- On the nameplate is also depicted other features as: Main power supply and terminal plan (Electric diagram)
- **The centronik serial number must be the same as the actuator serial number (printed on actuator and motor nameplates), if the actuator has been supplied as a whole unit.**
- **The centronik serial number allows defining and identifying all actuator data. It will be required for any consult concerning to the electric actuator.**



4.8 Features of the electronic switching and signaling unit

4.8.1 Local indication:

- A LCD display 48 character control panel including the following information:
 - Valve position and torque applied on actuator output shaft (Percentage, %)
 - Actuator output signals status (Outputs relays)
 - Actuator Serial number
 - Data logger: This menu indicates the number of the following information: Opening Operations, Closing operations, Open torque Faults, Close torque faults, Thermal faults, Number of cycles, Number of turns and Number of powering.
 - Symbols (Thermal, Overtorque, Battery, Alarm).
 - Settings menu: Menu Protected by password. Adjust the following data:
 - Set Open Position 0% (Adjust the close position)
 - Set Open position 100% (Adjust the open position)
 - Open Torque Value (Adjust the Open torque value for torque switching)
 - Close Torque Value (Adjust the Close torque value for torque switching)
 - Intermediate limit switching (Adjust middle travel, %; limit switch)
 - Alarm settings: Battery and/or Thermal and/or Overtorque.
 - TPS setting: Adjust of analogue position transmitter: 4/20mA-2/10V or 0/20mA-0/10V, direct or reverse polarity. Voltage configuration is optional; consult CENTORK.

- TTS Setting: Adjust of analogue position transmitter: 4/20mA-2/10V or 0/20mA-0/10V, direct or reverse polarity. Voltage configuration is optional; consult CENTORK.
 - Relays setting: 5 relay configurable, 7 relays as option (normally opened or normally closed, FRA, FRC, FPA, FPC, Thermal, Alarm, battery, overtorque, 2 intermediate limit switching (Adjust middle travel, %; limit switch)
 - Language setting: English, Spanish, German, French and Italian. Other languages under request.
 - Store/save configuration parameters.
 - Reset: Re-load default facility parameters
 - Activate/Deactivate battery of the electronic switching and signaling unit-
- Four LEDs for main indication:
- Red/green LED indicator (LED1 and LED4): Red “ON”: Valve fully opened / Green “ON”: Valve fully closed
 - Red LED indicator (LED2): Red “ON”: Alarm activated
 - Yellow LED indicator (LED3): Yellow “ON”: Valve in intermediate position

4.8.2 Position control:

- A position encoder, incorporated in the actuator, design permits continuous monitoring of valve position during motor and hand wheel operation, even when actuator is not powered.
- The calibration may be done with the control panel.
- Clockwise or anti-clockwise calibration.
- Maximum allowable actuator stroke; 100.000 turns (Output shaft)
- Minimum allowable actuator stroke; 2.5 turns (Output shaft)

4.8.3 Torque Control:

- A force sensor, incorporated in the actuator PTCS, allows continuous monitoring of valve torque during motor and handwheel operation.
- Tripping torque can be adjusted from 40% up to 100% of maximum Torque, in 1% steps, (According to electric actuators range) independent for each rotation sense (Open and close). The calibration may be done with the control panel.

4.8.4 Motor thermal protection:

- The motor is protected against overheating by thermostat embedded in the motor windings.

4.8.5 Output signal relays:

- 4 programmable Bistable relays and 1 programmable Monostable relay, 24VDC/250VAC as standard (Gold contact as option) and up to 12 programmable relays (Optional).

4.8.6 Position and torque analogue transmitters TPS and TTS (Optional):

- TPS Analogue position transmitter (2 wire active transmitter 0/20mA-0/10V o 4/20mA-2/10V direct or reverse polarity programmable). Voltage configuration is optional; consult CENTORK.
- TTS Analogue Torque transmitter (2 wire active transmitter 0/20mA-0/10V o 4/20mA-2/10V direct or reverse polarity programmable). Voltage configuration is optional; consult CENTORK.
- Both active transmitters are powered from internal voltage source of the electronic position transmitter.

5 MOUNTING TO THE VALVE

5.1 Pre-Installation Inspection

- Verify the actuators nameplate to insure correct model number, torque, operating speed, voltage and enclosure type before installation or use.
- It is important to verify that the output torque of the actuator is appropriate for the torque requirements of the valve and that the actuator duty cycle is appropriate of the intended application.

5.2 Output size

Check whether actuator output flange suits the flange of the valve to be driven. The latter should have been designed following the ISO5210 or ISO5211 standard, for standard application, or following the customer's specifications, for special application.

5.3 Output type

Check that the type of flange coupling of the actuator suits the valve to be driven (diameters and lengths). Those manufactured as Standard at CENTORK follow the ISO5210/5211 standards. Types of output drive:

- **Output type A:** If not otherwise specified in the order, it is supplied blank. The thread must be machined according to the stem of the valve to be driven. For the dismounting and machining of this type of output, see Appendix. Output type A models can withstand axial loads and torque
- **Output type B0, B1, B2, C:** It is supplied machined to the dimensions stated in the ISO 5210/5211 or DIN 3338 standard. For the dismounting and machining of this type of output, see Appendix. Output type B and C models **cannot withstand axial loads.**
- **Output type B3, B4:** It is supplied blank. Output type B models **cannot withstand axial loads.** For the dismounting and machining of this type of output, see Appendix.

5.4 Mounting

- Check size and the type of output match the valve to be driven.
- Degrease the mounting surfaces at actuator and valve thoroughly.
- Slightly grease the input shaft of the valve to be driven.
- Fit the actuator into the valve. In the event of a threaded output (type A), use the handwheel for turning the nut over the threaded stem.
- **Do not lift the actuator by the handwheel.**
- The actuator may be mounted in any position. Before mounting, check proper orientation actuator and valve in order to simplify access to handwheel, switching and terminal compartments (Maintenance and start-up tasks).
- The valve output shaft must be inline with the actuator output drive to avoid side-loading the shaft. To avoid any backlash no flexibility in the mounting bracket or mounting should be allowed.
- Using ISO Class 8.8 quality bolts, fasten crosswise controlling the applied torque according to the table in Appendix

5.5 Centronik unit frontal panel orientation

Centronik frontal panel position can be changed.

- Remove/Shut-off the centronik main power supply.
- Open the frontal panel; Unfasten/loose the 4 M6 metric bolts.
- Place/Orientate the frontal panel in the desired position; Check that o-ring sealing is not damaged and the centronik white cable (See figure below) which connects the frontal electronic board to main CPU board is not trapped. **Notice the red wire in the lower part of the cable depicts the right connection of the cable.**

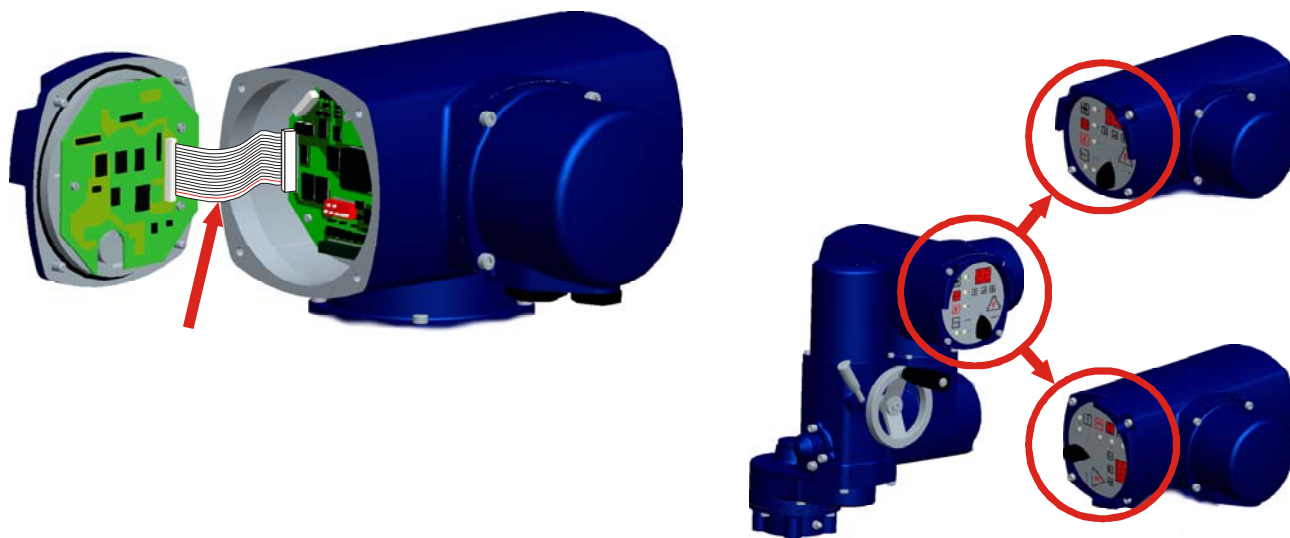

5.6 Electronic switching and signalling unit frontal panel orientation

It is not allowed to change/modify the orientation of the electronic switching and signalling unit frontal panel. When required, contact CENTORK



6 ELECTRICAL CONNECTIONS



CAUTION: Safety instructions on chapter 2 must be observed. Work on electrical system or equipment must only be carried out by skilled electrician.

6.1 Wiring diagram (electric manoeuvre)



Electric actuator datasheet, supplied with the actuator, includes a **PROPOSED WIRING DIAGRAM**, delivered with other technical documentation.

Features of electric and electronic components listed on appendix. Wiring diagram are included on appendix.

6.1.1 Duty service

6.1.1.1 ON/OFF duty

Digital input for Remote control:

- OPEN
- CLOSE
- STOP (ALARM RESET)
- DES (UNLOCK)

Characteristics: --.

Setting: --.

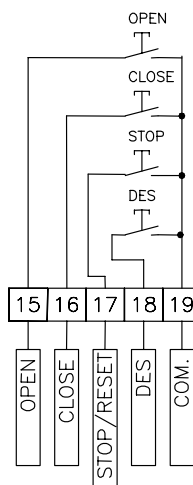

6.1.1.2 Modulating duty

Digital and analogue input for Remote control:

- ESD (Emergency Shut Down)
- RESET (ALARM RESET)
- POSITION (Set position)

Characteristics: Analogue input 220Ω.

Setting: Chapters 10.3.13 and 10.3.8.

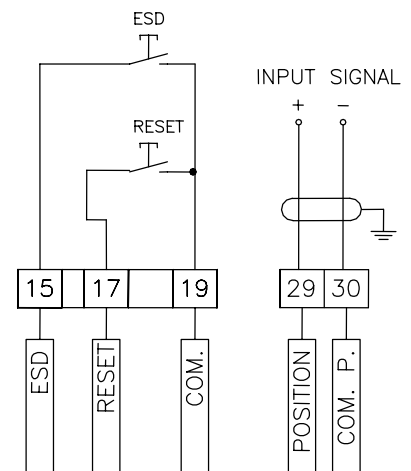

6.1.1.3 ON/OFF duty with position

Digital input for Remote control:

- OPEN
- CLOSE
- STOP (ALARM RESET)
- DES (UNLOCK)
- ESD (Emergency Shut Down)

Characteristics: --.

Setting: Chapter 10.3.8.

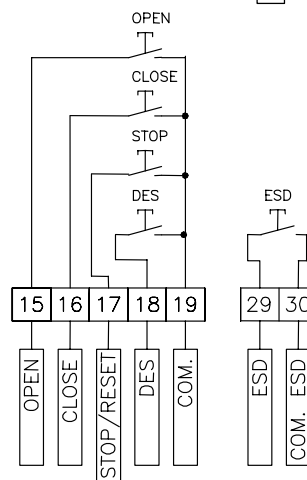

6.1.2 Components

6.1.2.1 Voltage supply

Voltage supply type available:

- 3 phases power supply: 220/240/380/400/420/440/460/500/600V ($\pm 10\%$), 50/60Hz ($\pm 5\%$)
- 1 phase power supply: 110/220/240V ($\pm 10\%$), 50/60Hz ($\pm 5\%$)
- DC power supply: 24VDC ($\pm 20\%$)



Where UPS systems are required, the power supply should have negligible harmonic distortion. In general terms actuators are designed to operate on power supplies conforming to recognised power supply standards such as EN 50160 – Voltage Characteristics of Electricity Supplied by Public Distribution systems.

6.1.2.2 Digital outputs

+24VDC 100 mA max load

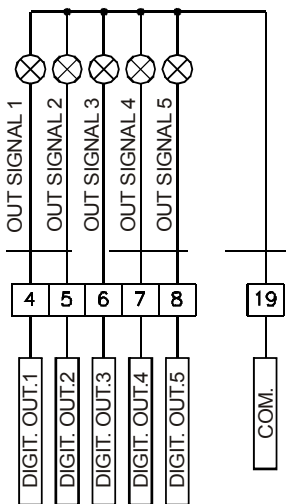

Digital outputs are programmable with the following functions:

- Valve OPEN
- Valve CLOSE
- Overtorque
- Overtorque reached in OPEN
- Overtorque reached in CLOSE
- Motor protection tripped
- Lost phase
- Anomaly
- Command signal failure($< 4\text{mA}$)
- Local selected
- Remote selected
- Intermediate position
- Position reached
- Rest time
- ESD signal

Characteristics: 24VDC, 100mA max.

Setting: Chapter 10.3.5.

6.1.2.3 Relay outputs

RELAY OUTPUTS

Max: 5A-30VDC

Max: 5A-250VAC / $\cos\phi=1$

(+) (-)

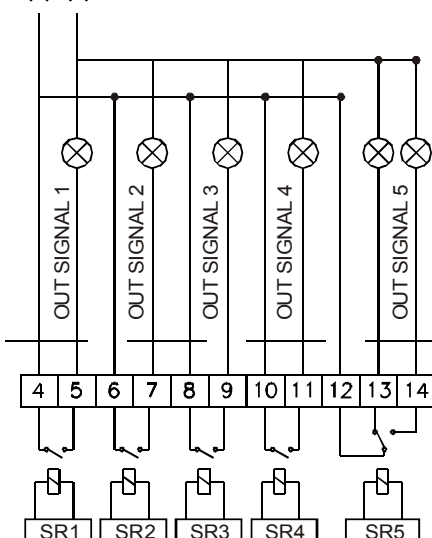

Digital outputs are programmable with the following functions:

- Valve OPEN
- Valve CLOSE
- Overtorque
- Overtorque reached in OPEN
- Overtorque reached in CLOSE
- Motor protection tripped
- Lost phase
- Anomaly
- Command signal failure($< 4\text{mA}$)
- Local selected
- Remote selected
- Intermediate position
- Position reached
- Rest time
- ESD signal

Characteristics:

- SR1 to SR4: 250VAC/24VDC, 5A max.
- SR5: 250VAC/24VDC, 2A max.

Setting: Chapter 10.3.5.

6.1.2.4 Position transmitter TPS

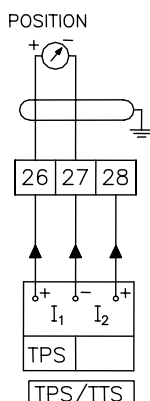

TPS Transmitter gives a signal (Current or voltage) proportional to valve position. The TPS transmitter is an optional element for ON-OFF duty centronik units.

Characteristics:

- Output Signal (current): 2 wires (0/4-20mA), 600Ω Max.
- Optional - Output Signal (voltage): 2 wires (0/2-10V), 1200Ω Min.
- Precision: < 1%.

Setting: See 10.2.1.6 chapter

6.1.2.5 Torque transmitter TTS

TTS Transmitter gives a signal (Current or voltage) proportional to actuator output torque. The TTS transmitter is an optional element.

Characteristics:

- Output Signal (current): 2 wires (0/4-20mA), 600Ω Max.
- Optional - Output Signal (voltage): 2 wires (0/2-10V), 1200Ω Min.
- Precision: < 1%.

Setting: See 10.2.1.7 chapter

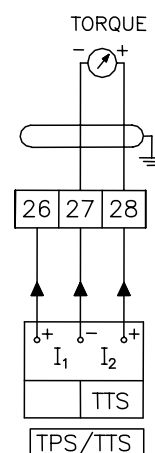

6.1.2.6 Capacitors

Capacitors for single-phase A.C. motors are delivered with electric actuators. In case of external connection, when due to capacitor dimension it is not possible to mount it inside of the centronik unit (Capacitors $C > 30 \mu F$), capacitors have to be installed on electric cabinet (External), as it is depicted on the actuator terminal plan and wiring diagram. Each capacitor is sized according to motor voltage and power.

6.1.2.7 Field bus

Field bus is an optional feature. Contact CENTORK for additional information.

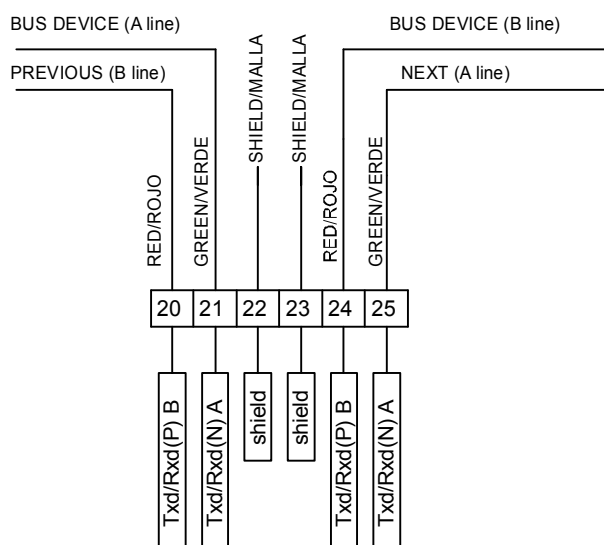

6.1.2.8 Other elements

3 or 7 additional output relays (Optional elements) are available for remote signalling. Relays are programmable, from the electronic switching and signalling frontal panel.

See Appendix for technical information and 10.2.1.8 chapter for setting.

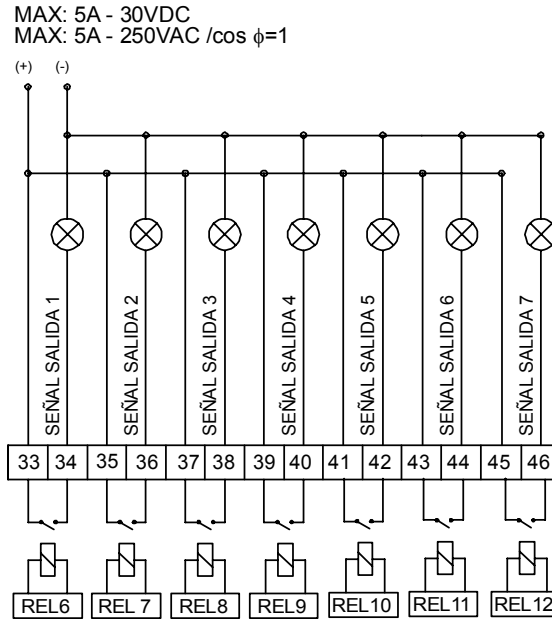



6.2 Terminal plan and wiring

The electric connection diagram or terminal plan is depicted on Electric actuator datasheet supplied with the electric actuator, and it can be found printed on a label inside of electrical compartment cover. The terminal plan is also marked on centronik nameplates

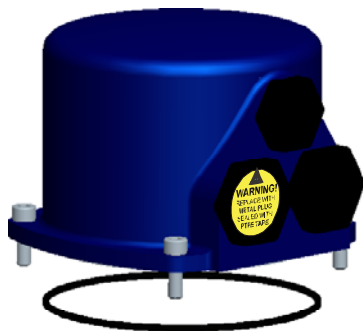
- Open the electrical cover. Feed the cable(s) through the cable glands. Fix proper cable glands according to IP67 or IP68 protection degree.
- **Fix proper cable glands according to IP67 or IP68 protection degree. Replace the protection plug with suitable metallic protection plug sealed with PTFE. Tighten cable glands and protection plugs to ensure enclosure IP67 (IP68 if applicable).**



- Connect the **internal earth cable terminal**  to the earth connection located inside of electric connection cover (M5 screw hole).
- Connect the **external earth cable terminal**  to the earth connection terminal (See picture)

Electric actuator with **Plug-socket connectors** with screws

- Unscrew the attachment plate from the connection cover.
- With a suitable screwdriver, connect the cables for the control signals according to the electric connection diagram.



Electric actuator with **Terminals connection**

- With a suitable screwdriver (SD 0,6x3,5 DIN 5264-A), connect the cables for the control signals according to the electric connection diagram.

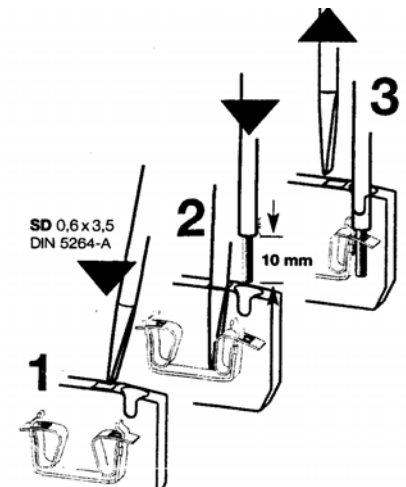
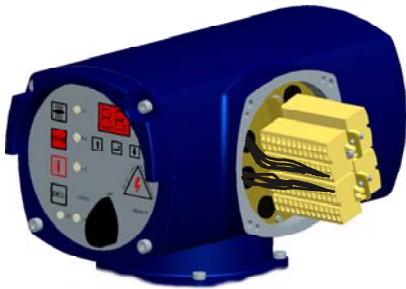

- Once you have checked that the wirings/connections have been properly carried out, close the electric cover checking its o-ring, greasing it slightly. Fasten the 4 screws crosswise.
- Check that all cable glands are correctly tightened.

6.3 Cable installation in accordance with EMC



Signal cables are susceptible to interference. Motor cables are interference sources.

- Lay cables being susceptible to interference or sources of interference at the highest possible distance from each other.
- The interference immunity of signal cables increases if the cables are laid close to the ground potential.
- If possible, avoid laying long cables and make sure that they are installed in areas being subject to low interference.
- Avoid long parallel paths with cables being either susceptible to interference or interference sources.
- For the connection of remote signals (Position transmitter, control input, digital output and remote input), screened cables must be used.

6.4 Centronik unit on wall bracket (as option)

When required, centronik unit can be mounted apart from the electric actuator (Difficult access to the valve). For centronik with wall bracket assembly option, please observe the following:

- Permissible cable distance between actuator and Centronik unit amounts to a maximum of 100m.
- Use suitable flexible and screened connecting cables.
- All wiring between electric actuator and centronik unit must be done -terminal to terminal- (i.e. terminal 1 to terminal 1, etc), according to enclosed actuator terminal plan.
- Connect the wires in correct phase sequence.
- Check the direction of rotation before switching on.

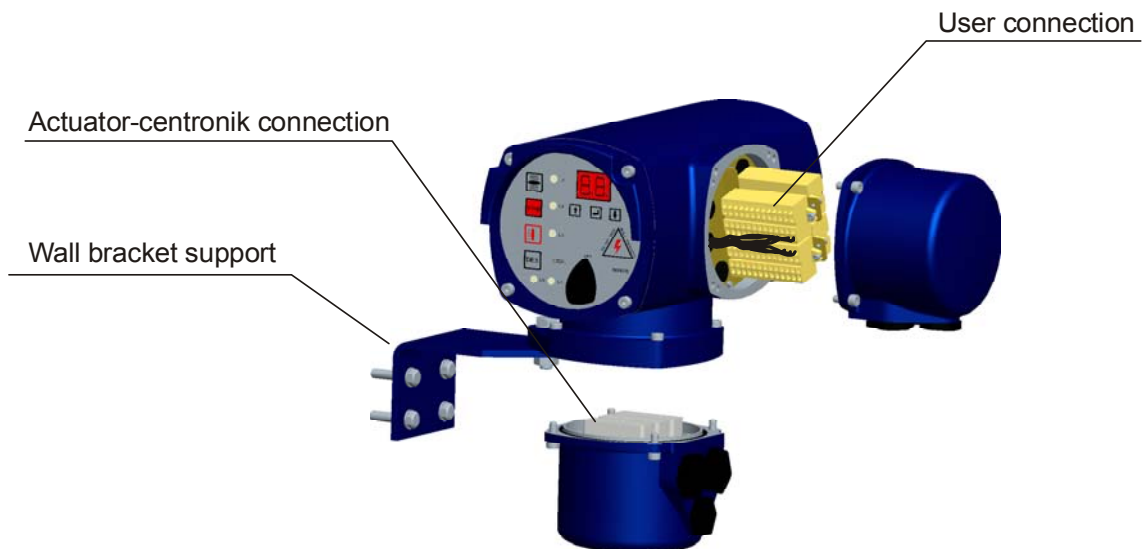

7 MANUAL OPERATION

CENTORK actuators are fitted with a handwheel for the manual actuation of the valve. In the case of simultaneous motorised and manual working, the motorised one will always be the preferential one, "**motor priority**".



Once the handwheel has been engaged is not possible to disengage, the override engagement lever returns automatically to motor position when the motor is operated. Do not press the lever when motor is running.

Procedure of engagement of manual operation:

- Turn the changeover lever 20° clockwise while slightly turning the handwheel.
- When you notice an increase in the resistance of the wheel, the manual control is engaged.
- Run the valve in the desired direction. Standard sense of rotation is clockwise to close. For greater operating speed you can connect any power tool, pneumatic or electric, to the hand-wheel shaft. The maximum speed allowed is 150 rpm.

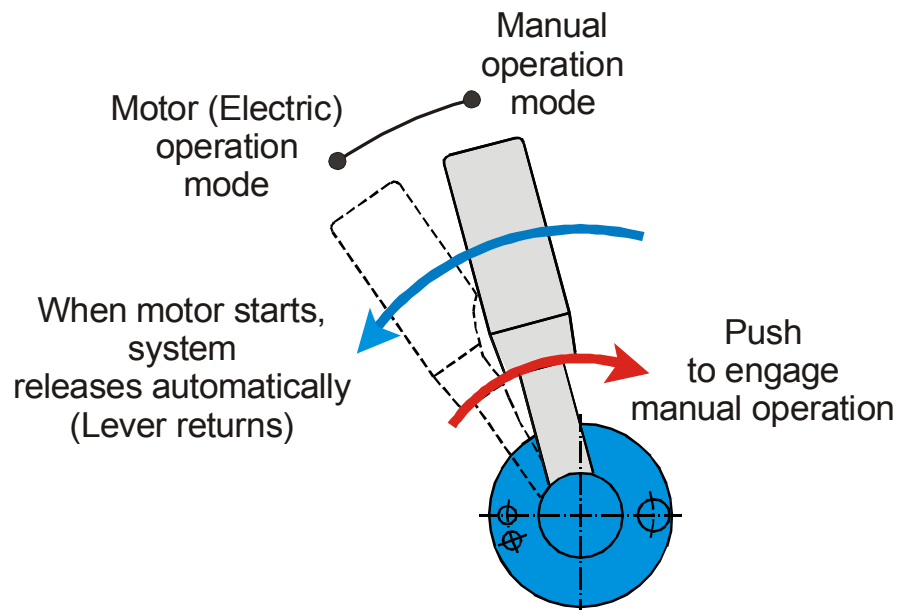
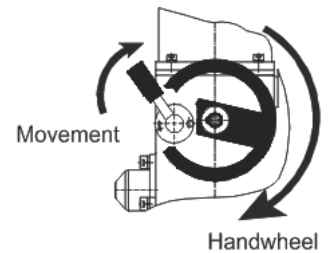

8 LOCAL MODE: CONTROL AND DISPLAYS ELEMENTS

The Centronik unit is equipped with local control:

- Pushbuttons:
 - With the OPEN - STOP – CLOSE pushbuttons, the actuator can be operated locally. Push buttons are self-retaining type, see 4.2.2 chapter.
 - With the UP-ENTER-DOWN pushbuttons, the operator can access to the program menu in order to set/change/configure the different parameters, functions and options.
- The LOCAL - OFF - REMOTE selector allows the control mode to be set.
- 5 indication lights show the actuator status from the front panel (chapter 8.3).
- A display shows the actuator status from the front panel:
 - For ***on-off with display*** and ***modulating*** duties centronik units, the display will indicate the real valve position (%opening)
 - For ***on-off*** duty, **the display will remain turn-off.**

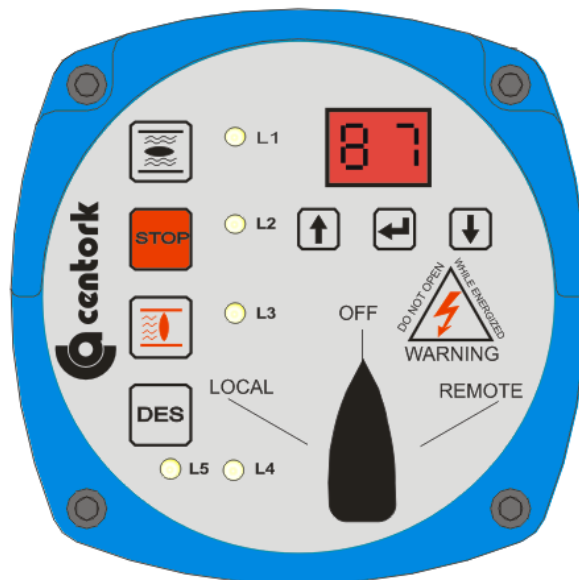

frontal panel



8.1 Lockable selector

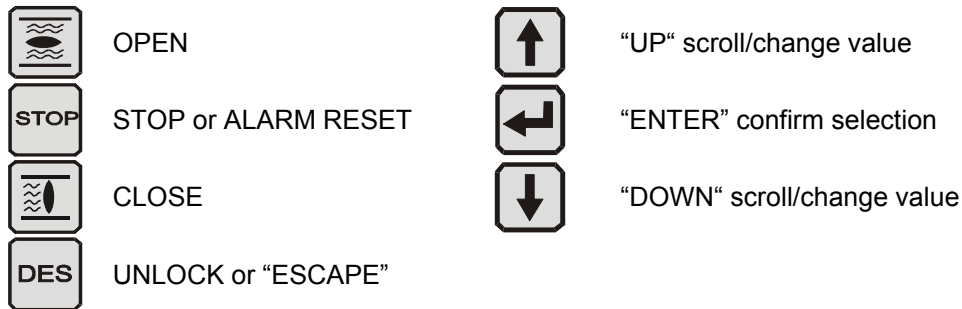

The selector LOCAL-OFF-REMOTE is lockable in all three positions. Unauthorized operation at the local controls is therefore prevented.

- **OFF**: In this operation mode, the actuator remains connected but does not responds to any order from the front panel or from the remote control. The front panel control indicates only the power supply status (led 5).
- **LOCAL**: With the push buttons OPEN-CLOSE-STOP located on the front panel, the actuator is operated locally.
- **REMOTE**: With the remote commands, the actuator is operated remotely (Remote inputs see 6.1.1 chapter)

8.2 Push-buttons



Pressing  and  with an open torque switch signal enables the user to open:

Pressing  and  with an open torque fault enable the user to close.

DES pushbutton in combination with **OPEN** or **CLOSE**: Actuator will start running and will ignore the Open torque (Or the close torque) switch signal for a while (Until a blinker pulse is detected by the centronik unit, then, if torque microswitch is still “energized”, motor will stop again). This function is made for releasing “stuck” valves.

8.3 Centronik LED indications

Five local LEDs indicate different signal:

L1	Red: Red blinking: Yellow blinking:	OPEN OPENING Limit switch failure
L2	Red: Red blinking: Yellow: Green:	Motor protection tripped Motor protection tripped and has disappeared Movement fault (blinker or TPS) OFF time executing in Stepping mode
L3	Green: Green blinking: Yellow blinking:	CLOSE CLOSING Limit switch failure
L4	Red: Green: Yellow blinking:	OPEN torque fault CLOSE torque fault Torque switch failure
L5	Green: Red: Yellow:	Correct phase connection Lost Phase Inverse phase connection
L1, L2, L3	Yellow:	Rest time executing

9 ELECTRONIC SWITCHING AND SIGNALING UNIT

 The figure depicts the frontal interface of the electric actuator. **It is forbidden to open the frontal panel without CENTORK permission; Otherwise warranty will not be applicable.**

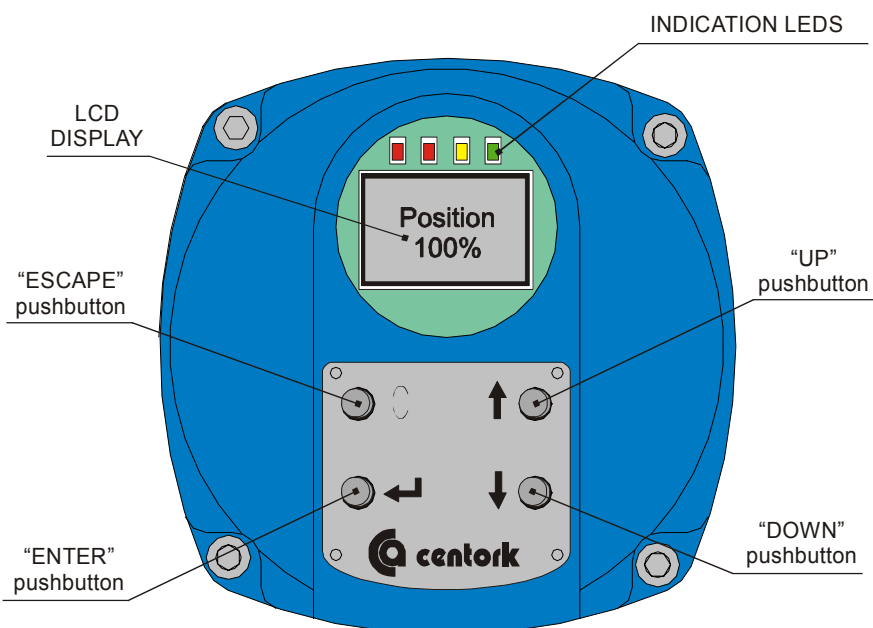

9.1 Data and features of the electronic switching and signalling unit

See 4.8 chapter.

9.2 LED indication

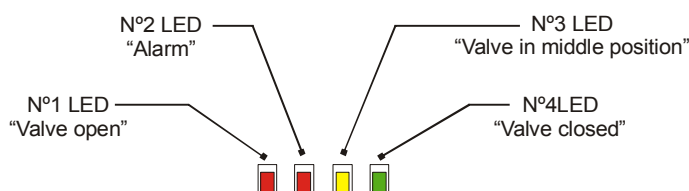

9.2.1 Local and remote operation modes:

See 4.2 chapter for local and remote operation modes. Under these modes, the LED indication will be:

- **N°1 LED:** Led will turn-on (Red colour) when valve is fully open (100% position)
- **N°2 LED:** Led will turn on (Red colour) when an “Anomaly event or condition” take places.
- **N°3 LED:** Led will turn on (Yellow colour) when valve is in middle position.
- **N°4 LED:** Led will turn on (Green colour) when valve is fully closed (0% position)

9.2.2 Setting mode:

- When fully closed (0%) and fully open (100%) position are being set/adjusted in the actuator frontal panel (See chapter), the motion sensor will detect the output shaft movement, at the same time, N°1 LED (red) and N°4 LED (green) will turn-on and turn-off sequentially, when sense of rotation changes, the LED light sequence changes as well.

- In case of “Fully open” (100%) and “Fully closed” (0%) positions have not set/adjusted before, the electronic switching and signalling unit will activate both relays “Valve open” and “valve closed” for safety purposes, waiting for proper setting (This condition is called “cols start”, when there is not position setting made yet)

9.3 Local pushbuttons of the electronic switching and signalling unit

- N°1 pushbutton: “**ESCAPE**”: Escape and/or cancel function.
- N°2 pushbutton: “**ENTER**”: Confirm and intro any value or option.
- N°3 pushbutton: “**UP**”: It is employed for navigation and/or scroll purposes in several screen and menus.
- N°4 pushbutton: “**DOWN**”: It is employed for navigation and/or scroll purposes in several screen and menus.

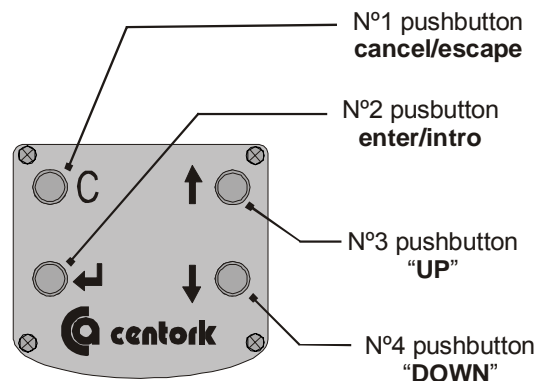

9.4 LCD screen

The LCD screen of the electronic switching and signalling unit is divided into three areas:

- Alarms, events and battery status (Deactivated and level of charge), when no alarm symbol is on screen, there is NO alarm events.
- Message and information area or field
- Position/torque visual bar.

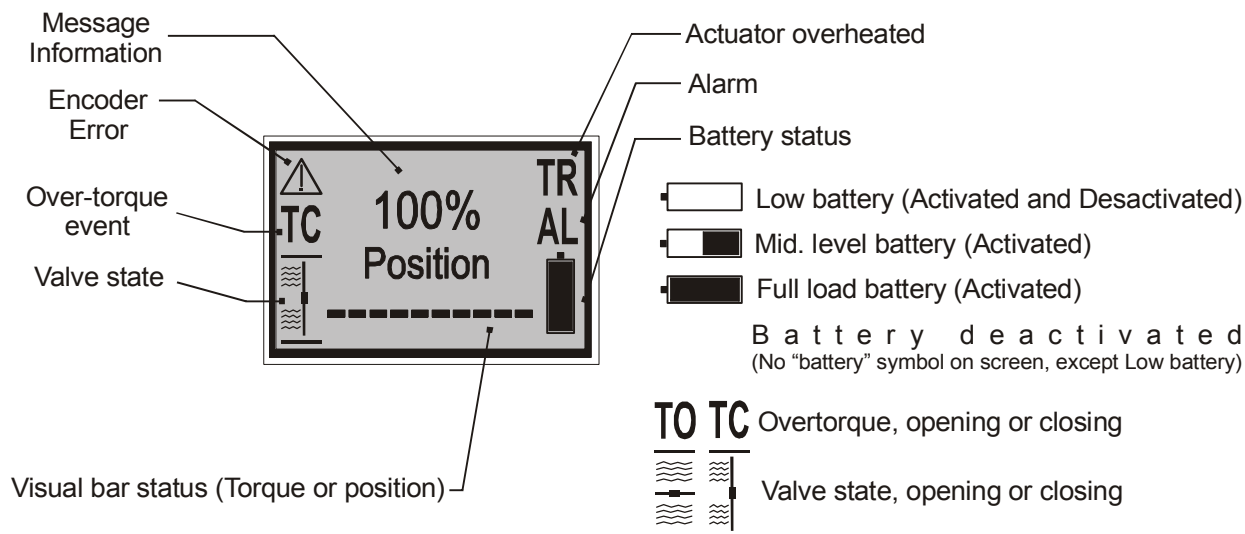

9.5 Battery of the electronic switching and signalling unit



Battery keeps and ensures the electronic switching and signalling functions when external power supply is NOT available:

- The electronic switching and signalling unit checks and measures the valve position and output torque applied on valve shaft, it is one of its main function. This device has been designed in order to operate with very low energy consumption. All parameters setting and configuration are store in its a non-volatile memory (See 10.2.1.14 chapter):
 - **External power supply mode:** When actuator with centronik unit is powered by mean of electric network (External power supply), the electronic switching and signalling unit employs the main power supply coming from the CENTRONIK unit.

- **Low energy mode:** When there is NOT external main power supply: The electronic switching and signalling unit operates with the energy supplied by a long-life battery; Any change of valve position will be detected and main functions will be ensure in such situation. Some secondary functions are in “stand-by” mode, not available.

 **Only CENTORK original batteries must be employed. CENTORK cannot warranty a correct actuator operation with other battery types and models.**

Battery replacement, see 12.5 chapter. The batteries have been sized for a 5 year operation life.

Actuators delivered from CENTORK facilities:

- **Battery is deactivated in order to safe energy during long-term storage. Battery must be ACTIVATED before the start-up and settings (See 10.2.1.12 chapter)**
- **When CENTORK supplies electric actuators mounted on valves, with pre-settings already made, in those cases, battery is ACTIVATED.**
- **When electric actuators are mounted on valve, by valve manufacturers or valve distributors, some settings may have been done there. Contact them for any additional information before any change/manipulation is made. DO NOT modify any setting without their permission.**

From an energy point of view, there are two operation mode for the electric actuator:

9.5.1 External power supply operation mode

When actuator with centronik unit is powered by mean of external power supply (Electric network), the electronic switching and signalling unit is powered directly by the centronik unit, the unit runs in “external power supply mode”:

- The battery is by-passed; There is NOT energy consumption (nearly negligible)
- The electronic switching and signalling unit LCD turns on, high brightness.
- The electronic switching and signalling unit checks the battery energy level every 30 minutes. A battery load status is indicated in the LCD of the unit (See 9.4 chapter), by mean of an icon.

9.5.2 Low energy operation mode

When actuator with centronik unit is NOT powered (External power supply) and battery is activated (See 10.2.1.12 chapter) the electronic switching and signalling unit runs in LOW ENERGY MODE. The electronic switching and signalling unit only runs powered by mean of the battery energy. In low energy mode two status are possible:

- **Sleeping or stand-by mode:**
 - The electronic switching and signalling unit reduces the energy consumption:
 - LCD is turn-off (Deactivated).
 - The indication LEDs of the electronic switching and signalling unit will remain switch-off.
 - The TPS-TTS analogue transmitters and torque measurement system will be deactivated.
 - The electronic switching and signalling unit will monitor (check and measure) any valve position change. When electronic switching and signalling unit detects any change on valve position or the **C** pushbutton is pressed, then the unit moves to “ACTIVE” mode.

- **Active mode:**

When electronic switching and signalling unit detects any change on valve position or the **C** pushbutton is pressed, then the unit moves from “sleeping/stand-by” mode to “ACTIVE” mode.

This “ACTIVE” mode has the following features:

- LCD screen will turn-on in a “low bright” mode.
- The LCD screen will update the valve position indication (% and bar status) and will activate the relays, when proceed.
- The actuator torque measurement system will be deactivated.

When NO motion is detected on actuator output shaft or any input is received from keyboard (Pushbuttons **UP**, **DOWN**, **ENTER** or **C**) during 30 seconds, the electronic switching and signalling unit leaves the ACTIVE mode and returns to "SLEEPING/STAND-BY" mode, the LCD will turn-off.

10 SETTINGS AND PRELIMINARY TESTS (START-UP)



CAUTION: Safety instructions on chapter 2 must be observed. Work on electrical system or equipment must only be carried out by skilled electrician.

- Before to start with the preliminary test, actuator should be correctly mounted on valve and correctly wired as well, according to previous 4.8 and 0 chapters.
- A commissioning routine is recommended (Visual inspection) according to instructions of 3.2.1 chapter.
- It is recommended to move the valve to middle positions before to do any setting or verification described on next chapters. Operate or move the valve manually (Chapter 7) and check that the actuator rotates in the right direction (Visual disc indicator or valve shaft could help for this). Instructions have been made for standard electric actuators: CLOCKWISE TO CLOSE.



NOTE: If actuator has been supplied already assembled onto the valve by valve manufacturer, the settings made originally by the manufacturer should NOT be modified on site without the authorisation of the latter, otherwise, serious damage may be caused both to the valve and to the actuator.

- Achieve the following setting procedure:

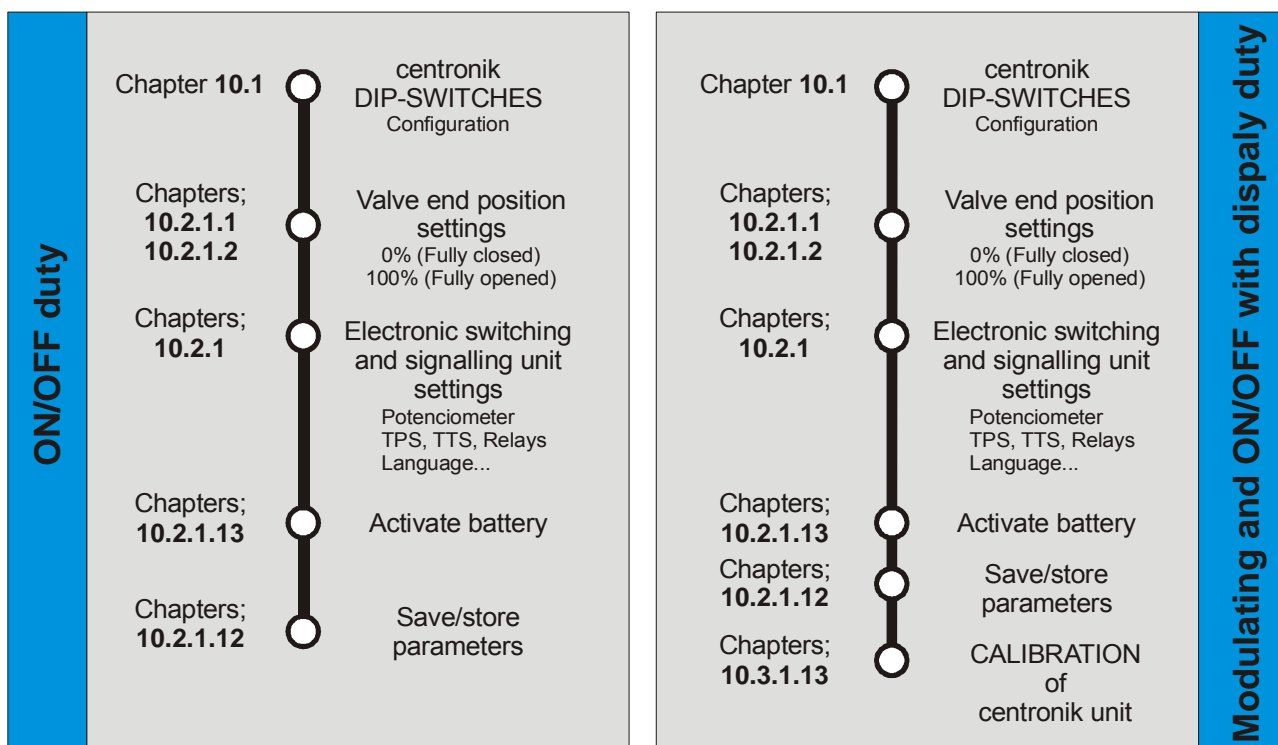

10.1 DIP-SWITCHES configuration

⚠ Caution!: This is a sensitive electronic device. Manipulation of setting switches should be made very carefully, in a way that other electronic components are not damaged.

In order to configure the Dipswitches, switch-off the Centronik unit (led 5 OFF) and open the centronik front panel carefully. In the CPU board, the DIPSWITCHES are located as indicated in the next figure.

⚠ Once the DIPSWITCHES have been configured, close the frontal panel: Check that any wire is not tripped by frontal panel, when closing and verify that o-ring is not damaged or cut. Centronik frontal panel has to be correctly tightened.

CELLS in grey colour: CENTORK FACTORY STANDARD.



10.1.1 Operation mode

SW1	SW2	SW3	Operation mode
ON	OFF	OFF	Open by limit switching and close by torque switching
OFF	ON	OFF	Open and close by limit switching
ON	ON	OFF	Open and close by torque switching

⚠ Note: Open or close by torque switching means that the Centronik consider that the valve is closed or opened when the open/close limit switch and the open/close torque switch are activated, otherwise, the Torque signal can be considered as an overtorque condition in middle position. Limit switch must be adjusted as in **Open and close by limit switch**.

10.1.2 Centronik output signals configuration (Only in ON/OFF duty)

SW5	SW6	SW7	OUTPUT 1	OUTPUT 2	OUTPUT 3	OUTPUT 4	OUTPUT 5
OFF	OFF	OFF	Valve OPEN	Valve CLOSE	LOCAL	REMOTE	ANOMALY
ON	OFF	OFF	Overtorque reached in OPEN	Overtorque reached in CLOSE	LOCAL	REMOTE	ANOMALY
OFF	ON	OFF	Valve OPEN	Overtorque reached in CLOSE	LOCAL	REMOTE	ANOMALY
ON	ON	OFF	Valve OPEN	Valve CLOSE	Overtorque reached in OPEN	Overtorque reached in CLOSE	ANOMALY
OFF	OFF	ON	Valve OPEN	Valve CLOSE	Overtorque	Motor overheat (Motor protection tripped)	ANOMALY

Anomaly: Any of the following events: Limit switch fault, torque switch fault, blinker fault, lost phase or Motor thermal protection tripped.

10.1.3 Actuator and valve (Sense of rotation)

! Electric actuator and valve sense of rotation must be the same. Electric actuator sense of rotation criteria is **CLOCKWISE TO CLOCK**. Sense of rotation is critical for many components (Relays, 4-20mA transmitters). A correct operation cannot be warranty in case of different sense of rotation valve/actuator.

- Operate the Electric actuator via handwheel (See Manual operation, chapter 7).
- Check that running the handwheel clockwise, valve moves to close. If the turn direction is not correct, stop immediately and verify.
- Configure the DIPSWITCH 4.

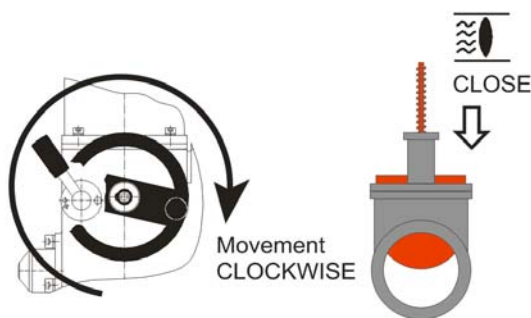

SW4	Direction to close
ON	Anti-clockwise
OFF	Clockwise

! Instructions have been made for standard electric actuators: **CLOCKWISE TO CLOSE**. In case of **ANTI-CLOCKWISE** sense of rotation, contact **CENTORK**.

10.1.4 Posicion transmitter range

! This DIPSWITCH is only for **MODULATING** duty and **ON-OFF WITH DISPLAY** duty

SW6	TPS range
OFF	0/20mA
ON	4/20mA

Note: the **SW6** must be configured in accordance to the TPS setting (10.2.1.6 chapter)

10.1.5 Remote mode selection

SW8	Remote mode selection
ON	Analogue input control (modulating duty) Parallel input control (ON/OFF duty)
OFF	Fieldbus (Optional)

! Once the **DIP-SWITCHES** have been configured, close tighten the frontal panel: Check that **NO** wire is trapped by frontal panel, when closing and verify that o-ring is not damaged or cut.

10.2 Settings of the electronic switching and signalling unit

The actuator electronic switching and signalling frontal panel is the interface with the user. Setting/configuration of the actuator parameters and local feedback information is made by mean of the frontal pushbuttons, LCD display and LEDs indications. There are three categories of menus:

- Main menu: 7 screens, see figure below.
- Setting menu: The access to this setting menu is made through to the main menu
- Data-logger menu: The access to this setting menu is made through to the main menu.

Users can move/navigate through the different menus and screens by pressing UP, ENTER and DOWN pushbuttons.

! ATENTION: After any change or modification in parameters or setting it is required to STORE/SAVE PARAMETERS before quitting the Setting mode (See 10.2.1.14 chapter)

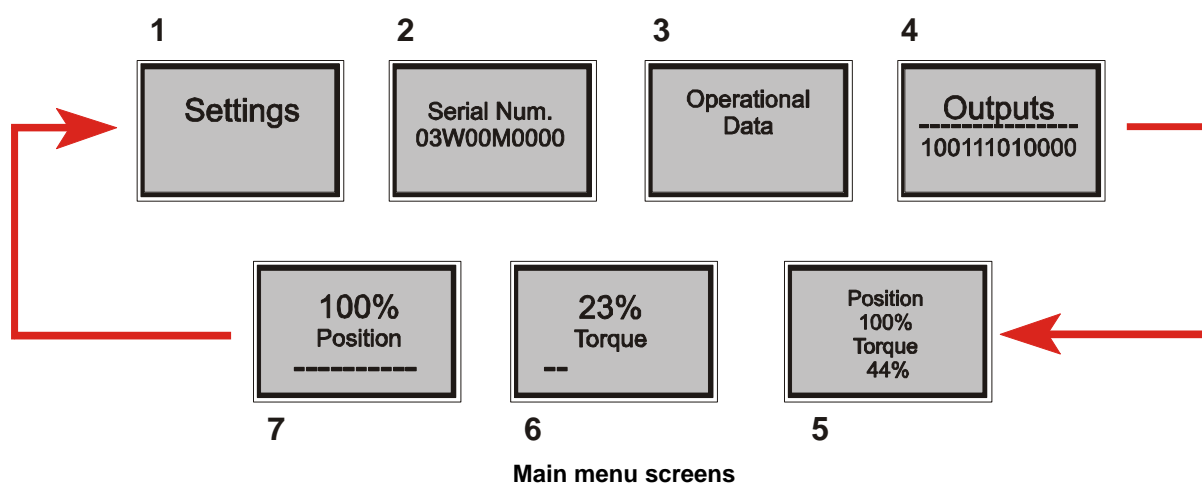

10.2.1 Settings screen (N°1 screen)

This menu permits to do the actuator settings and configure the parameters of the electronic switching and signalling.

! NOTE: If actuator has been supplied already assembled onto the valve by valve manufacturer, the settings made originally by the manufacturer should NOT be modified on site without the authorisation of the latter, otherwise, serious damage may be caused both to the valve and to the actuator.

- From main menu screen, pressing **UP** and **DOWN** pushbuttons select the **Settings** screen (N°2 screen). Press **ENTER** pushbutton. A password screen will appear. The password code is formed by 4 digits code.
- Using **UP** and **DOWN** pushbuttons and **ENTER** to confirm, user has to insert/set each digit, then, when pressing **ENTER**, cursor will move to next digit until full-code (4 digits) is formed. In case of error (Incorrect code), program will move back to **Settings** screen (N°2 screen).

1.0

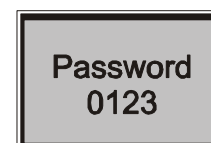

! The CENTORK default code is 0123. It is possible to change the password, see chapter. CAUTION: Password changing is a delicate operation. Write it down and keep it safety. In case of missing, contact CENTORK.

- With a correct password, the program gets into the submenus of the setting mode.
- In setting mode, the open (100%) and close (0%) limit position relays are deactivated. After 30 minutes program escapes to the setting menu and returns to main menu (n°7 screen, valve position indication).
- It is necessary to store/save parameters when any change or setting is made.

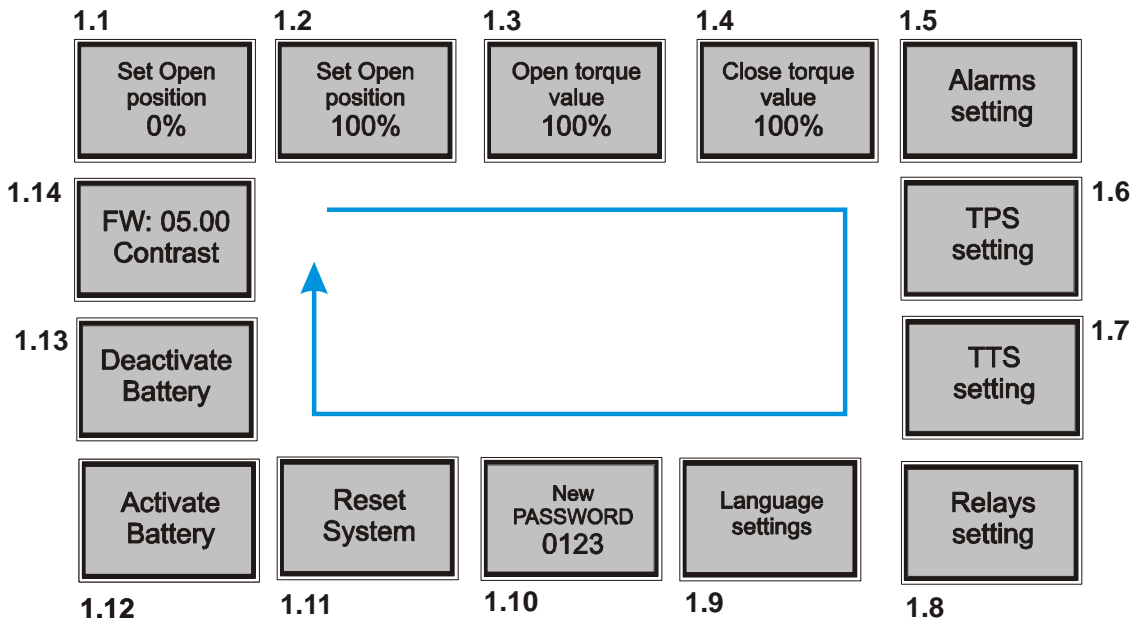

Screens of Settings menu

10.2.1.1 Set of Open position 0% -Fully closed position- (1.1 screen)

This menu permits to set “**Valve Fully closed position**” or Open position 0%.

- Run the actuator manually (By mean of the actuator handwheel) or electrically to the desired “Fully closed position”
- Notice that when actuator is moving the indication N°1 LED (red) and N°4 LED (green) will turn-on and turn-off sequentially. If motion reverses (The sense of rotation changes) the lights sequence reverses as well.
- Once the desired “Fully close” position is reached, then, press the **ENTER** pushbutton for 5 seconds until the **Set Open position 0%** screen disappears and a OK screen will be displayed. Press **ENTER** to confirm: Program will move to **Set Open position 100%** (Valve Fully open position) screen.

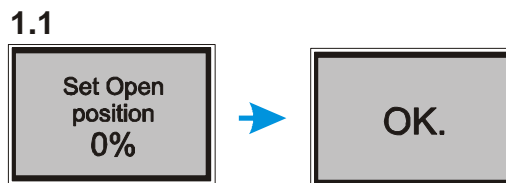
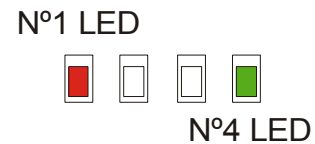

- If no change on valve position is required, press **ENTER** to skip this screen

10.2.1.2 Set of Open position 100% -Fully open position- (1.2 screen)

This menu permits to set “**Valve Fully open position**” or Open position 100%.

- Run the actuator manually (By mean of the actuator handwheel) or electrically to the desired “Fully open position”
- Notice that when actuator is moving the indication N°1 LED (red) and N°4 LED (green) will turn-on and turn-off sequentially. If motion reverses (The sense of rotation changes) the lights sequence reverses as well.

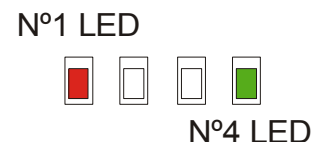

- Once the desired “Fully open” position is reached, then, press the **ENTER** pushbutton for 5 seconds until the **Set Open position 100%** screen disappears and a OK screen will be displayed.
- Press **ENTER** to confirm and move to next menu (Open torque value screen)

1.2

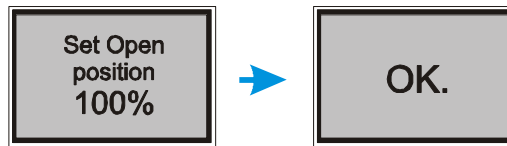

10.2.1.3 Set of Open torque value (1.3 screen)

This menu permits to set “**Open torque value**” in opening sense of rotation: When torque on actuator output shaft is higher than preset Open torque value, the relays will be activated if they are configured as **Overtorque reached in: Open**. (See 10.2.1.8 chapter).

The open torque value is displayed as a percentage (%) of the max. torque value marked on actuator nameplates. The value selected can be between a minimum of 40% and a maximum of 100%. It is not allowed to exceed these values.



NOTE: there is a time delay between the relay activation and motor stop. For high-speed actuators or hard seating valves (Metal-to-metal seating) real torque can be higher than set torque value due to this time delays: It is recommended to start with a low torque set value.

- Enter in the **Settings** (N°1 screen) by entering the correct password (See 10.2.1 chapter)
- Pressing **UP** and **DOWN** select the **Open torque value** screen (1.3 screen). Press **ENTER** to select.
- Pressing **UP** and **DOWN** set the % value, by 1% increments. When keeping pressing the pushbutton **UP** or **DOWN**, the figure will increase/decrease faster. When desired value is set, then, press **ENTER** pushbutton. The **Open set value** screen will disappear and a **OK** screen will be displayed.
- Press **ENTER** to confirm. Program will move to next menu.

1.3

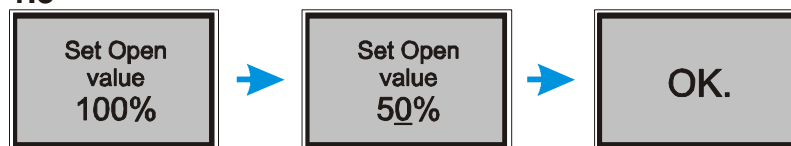

10.2.1.4 Set of Close torque value (1.4 screen)

This menu permits to set “**Close torque value**” in closing sense of rotation: When torque on actuator output shaft is higher than preset Close torque value, the relays will be activated if they are configured as **Overtorque reached in: Close**. (See 10.2.1.8 chapter). The close torque value is displayed as a percentage (%) of the max. torque value marked on actuator nameplates. The value selected can be between a minimum of 40% and a maximum of 100%. It is not allowed to exceed these values.



NOTE: there is a time delay between the relay activation and motor stop. For high-speed actuators or hard seating valves (Metal-to-metal seating) real torque can be higher than set torque value due to this time delays: It is recommended to start with a low torque set value.

- Enter in the **Settings** (N°1 screen) by entering the correct password (See 10.2.1 chapter)
- Pressing **UP** and **DOWN** select the **Close torque value** screen (1.4 screen). Press **ENTER** to select.

- Pressing **UP** and **DOWN** set the % value, by 1% increments. When keeping pressing the pushbutton **UP** or **DOWN**, the figure will increase/decrease faster. When desired value is set, then, press **ENTER** pushbutton. The **Close set value** screen will disappear and a **OK** screen will be displayed.
- Press **ENTER** to confirm. Program will move to next menu.

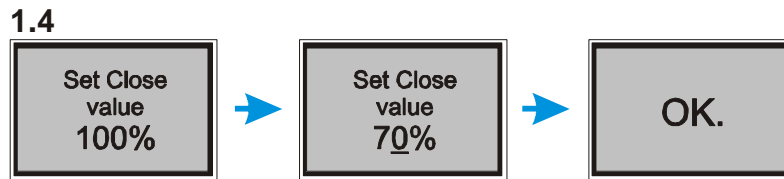

10.2.1.5 Alarms setting (1.5 screen)

The following events are defined as “Alarm condition”:

- Actuator overheats (Actuator thermal protection device activated)
- Battery alarm: Battery low or battery deactivated.
- Anomaly: Any of previous case; Motor overheats or battery alarm

This menu permits to set the type of “Alarm”. This event will activate the relay (ON or OFF, depending on relay configuration) if they are configured as **Alarm condition activated**. (See 10.2.1.5 chapter). Also, an alarm symbol will be displayed on LCD screen (See 9.4 chapter)

- Enter in the **Settings** (N°1 screen) by entering the correct password (See 10.2.1 chapter)
- Pressing **UP** and **DOWN** select **Alarms setting** screen (1.5 screen). Press **ENTER** to select.
- Pressing **UP** and **DOWN** set the desired Alarm condition: **Thermal**, **Battery** or **Alarm** (Both events, motor overheats or battery). Then press **ENTER** to select it. A new screen will appear in order to configure if the alarm event will be activated (**YES**) or will be ignored (**NO**). Notice that cursor will move from the left side to the right side of the screen. Press **ENTER** to select.
- Press **ESCAPE** to confirm and move to previous screen **Alarms setting** (1.5 screen).

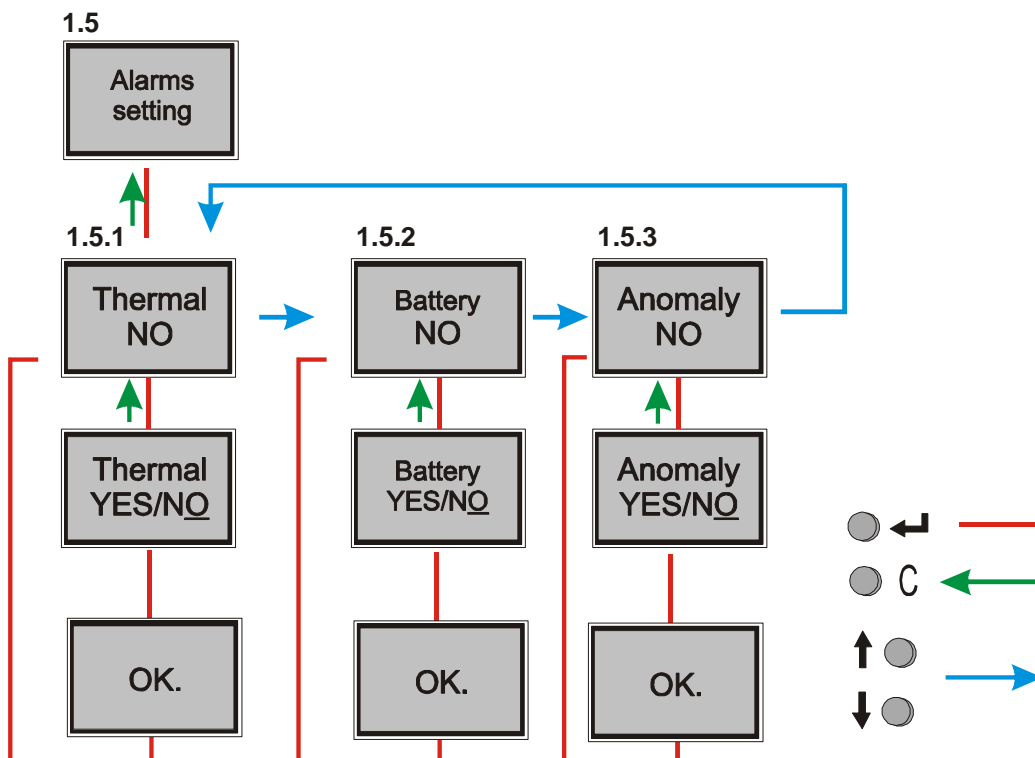

10.2.1.6 Electronic position transmitter TPS setting (1.6 screen)

- This menu allows to set and configure the actuator electronic Position transmitter, called TPS (See 4.8.6 and 4.8.6 chapters). TPS generates a 4-20 mA continuous signal proportional to valve position. As limit end position CLOSE (0%) and OPEN (100%) are set, TPS automatically is set or auto-calibrated to its end values (4-20mA/2-10V or 0-20 mA or 0-10Volts).
- It is not necessary any additional calibration process. User only has to define or set the type of signal and its configuration. **NOTE: mA is the standard configuration for TPS feedback signal. Volts configuration is optional**

Process:

- Enter in the **Settings** (N°1 screen) by entering the correct password (See 10.2.1 chapter)
- Pressing **UP** and **DOWN** select **TPS setting** screen (1.6 screen). Press **ENTER** to select.
- Pressing **UP** and **DOWN** set the desired Polarity: **Direct** (Valve fully closed 4 mA) or **Reverse** (Valve fully closed 20 mA), press **ENTER** to select it. A new screen will appear in order to configure the feedback signal: 4-20 mA or 0-20 mA (0-10V). Pressing **UP** and **DOWN** set the desired value. Press **ENTER** to select. A OK message screen will appear.
- Press **ESCAPE** to confirm and move to previous screen **TPS setting** (1.6 screen).

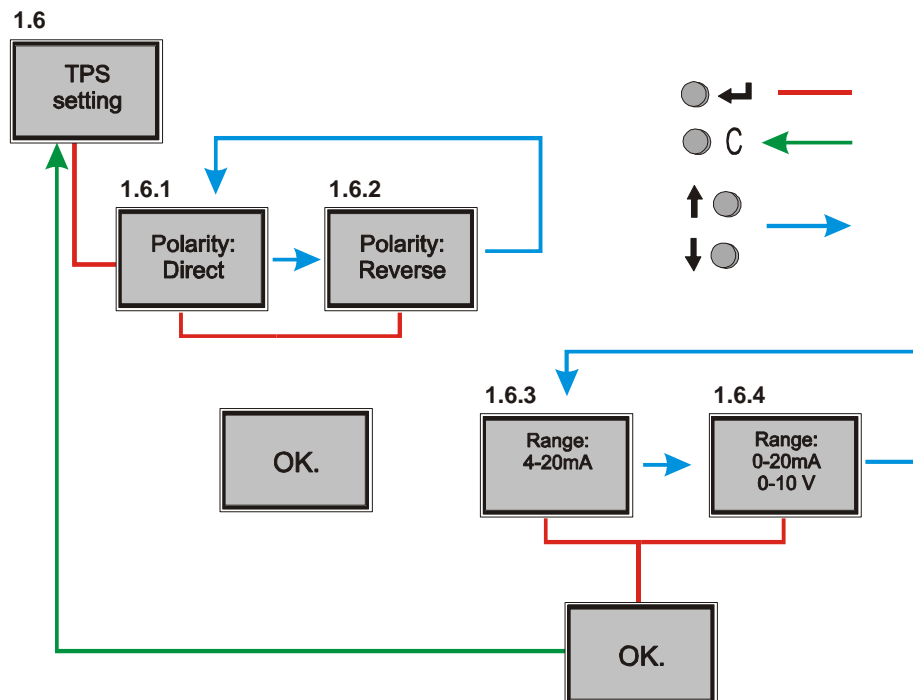

10.2.1.7 Electronic torque transmitter TTS setting (1.7 screen)

- This menu allows to set and configure the actuator electronic torque transmitter, called TTS (See 4.8.6 and 4.8.6 chapters). TTS generates a 4-20 mA continuous signal proportional to actuator output shaft torque. 100% of maximum torque corresponds to 20 mA or 10 Volts.
- It is not necessary any additional calibration process. User only has to define or set the type of signal and its configuration. **NOTE: mA is the standard configuration for TPS feedback signal. Volts configuration is optional**

Process:

- Enter in the **Settings** (N°1 screen) by entering the correct password (See 10.2.1 chapter)
- Pressing **UP** and **DOWN** select **TTS setting** screen (1.7 screen). Press **ENTER** to select.
- Pressing **UP** and **DOWN** set the desired Polarity: **Direct** (Valve fully closed 4 mA) or **Reverse** (Valve fully closed 20 mA), press **ENTER** to select it. A new screen will appear in order to configure the feedback signal: 4-20 mA or 0-20 mA (0-10V). Pressing **UP** and **DOWN** set the desired value. Press **ENTER** to select. A OK message screen will appear.

Press **ESCAPE** to confirm and move to previous screen **TTS setting** (1.7 screen).

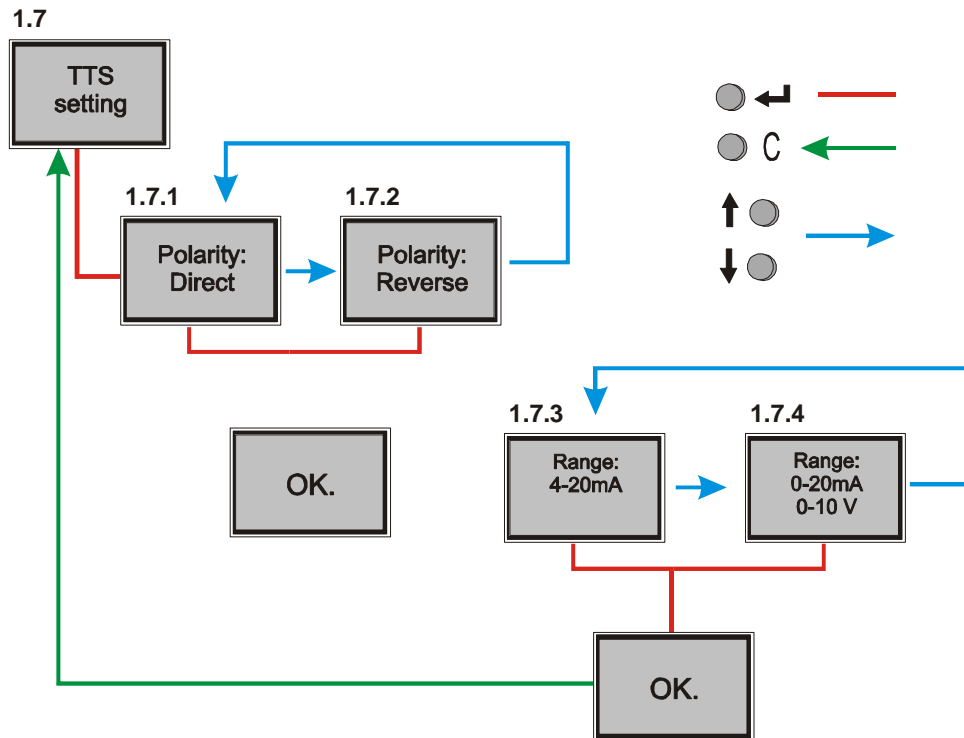

10.2.1.8 Relays setting (1.8 screen)

- This menu allows to set and configure the electronic switching and signalling unit relays of the actuator:
 - o **The 1 to 5 relays are employed by the centronik unit, for internal control. They cannot be modified by user.**
 - o The extra relays (See 4.8.5 and 6.1.2.8 chapters) can be configured by mean of Relays setting scree (1.8 screen). Check terminal plan in order to know the number of available relays.

Process:

- Enter in the **Settings** (N°1 screen) by entering the correct password (See 10.2.1 chapter)
- Pressing **UP** and **DOWN** select **Relays setting** screen (1.8 screen). Press **ENTER** to select. Program will move to the first relay screen Relay1
- Pressing **UP** and **DOWN** set the desired Relay status: **Normally closed** or **Normally Opened**- Press **ENTER** to confirm.
- Pressing **UP** and **DOWN** set the configuration of the type of event:
 - Overtorque reached in Close: Overtorque event in close direction (Torque relay tripped)
 - Overtorque reached in Open: Overtorque event in open direction (Torque relay tripped)
 - Reached position: Close: Valve fully closed (0% open)
 - Reached position: Open: Valve fully open (100% open)
 - Motor protection tripped: Motor overheats and motor thermal protection tripped.
 - Alarm condition activated.
 - Intermediate position 1: x%: Valve in x% position, where x is the desired middle position.
 - Intermediate position 2: y%: Valve in y% position, where y is the desired middle position.
- Press **ENTER** to select the desired configuration. A **OK** message screen will appear. Press **ENTER** again, the program will move to **Relay** screen.

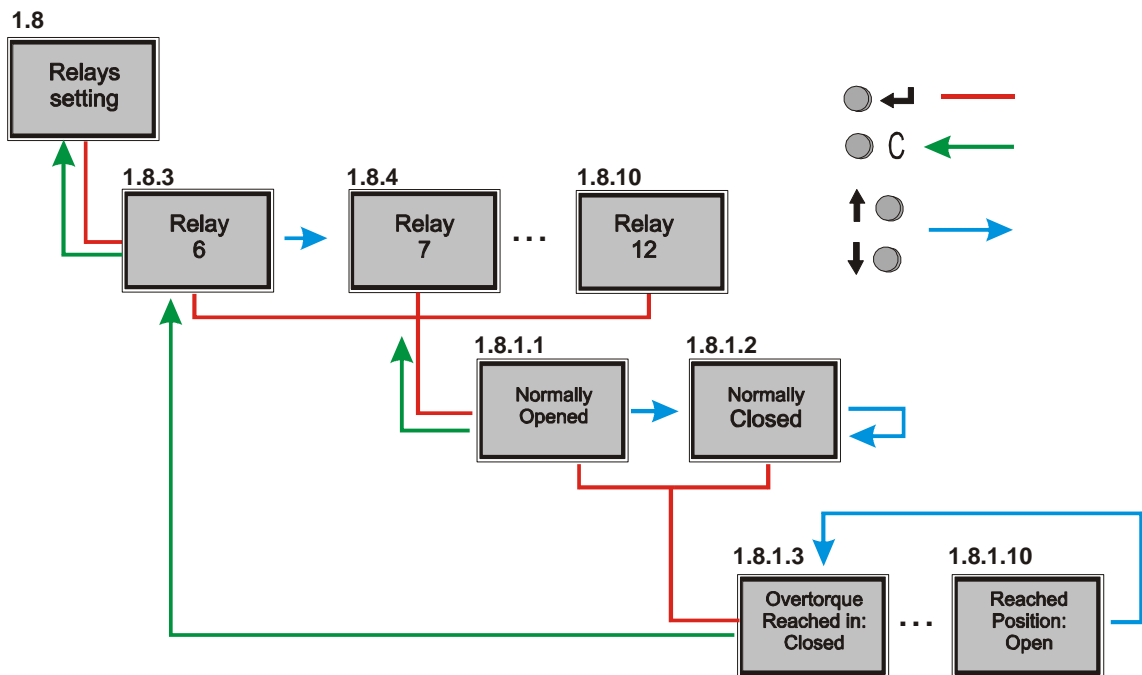

Notice that there is an Outputs screen (SCREEN 7) where it can be display the actual state of RELAYS, see 10.2.4 chapter.

- 0: Relay or condition no activated.
- 1: Relay or condition activated.

10.2.1.9 *Language setting (1.9 screen)*

This menu permits to set and configure the language of the interface of switching and signalling unit.
Process:

- Enter in the **Settings** (N°1 screen) by entering the correct password (See 10.2.1 chapter)
- Pressing **UP** and **DOWN** select **Language setting** screen (1.9 screen). Press **ENTER** to select.
- Pressing **UP** and **DOWN** set the desired idiom. Press **ENTER** to confirm.
- Save change made.

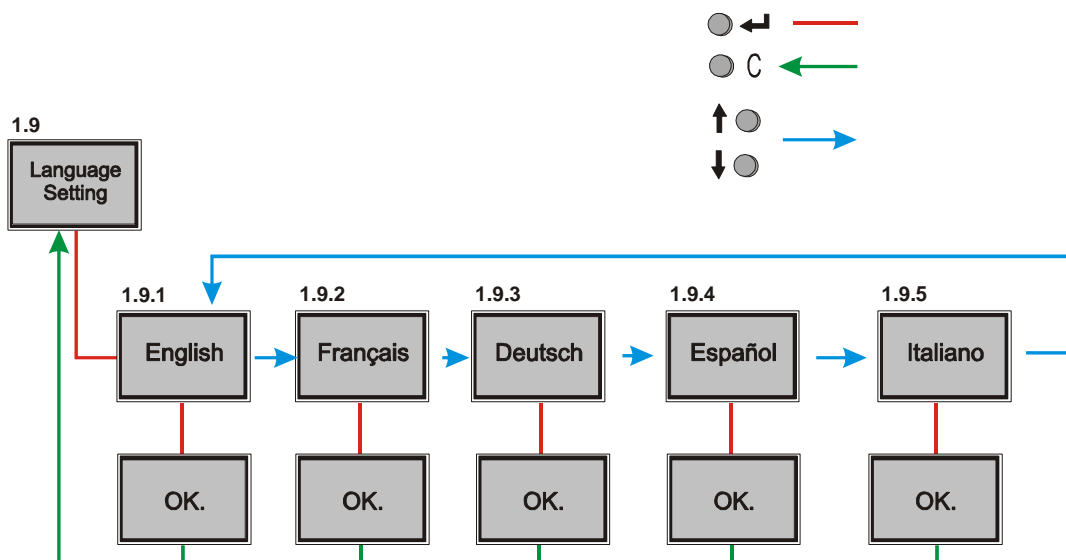

10.2.1.10 New password (1.10 screen)

This menu permits to change the password required to access to **Setting** screen (N°1 screen).
Process:

- Enter in the **Settings** (N°1 screen) by entering the correct password (See 10.2.1 chapter)
- Pressing **UP** and **DOWN** select **New password** screen (1.10 screen). Press **ENTER** to select.
- A new screen with actual password will be display. The cursor will be placed in the first digit.
- Using **UP** and **DOWN** pushbuttons and **ENTER** to confirm, user has to insert/set each digit, then, when pressing **ENTER**, cursor will move to next digit until full-code (4 digits) is formed.
- Finally, a OK.message screen will appear.
- Save changes (See 10.2.1.14 **Store setting** menu chapter)



CAUTION: Password changing is a delicate operation. Write it down and keep it safety. In case of missing, contact CENTORK.

1.10

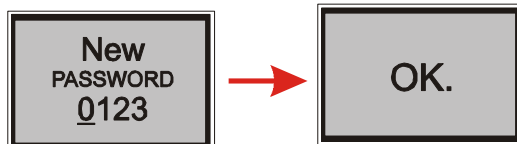

10.2.1.11 Reset system (1.11 screen)

This menu permits to reset the actuator, similar like power off and power on. Process:

- Enter in the **Settings** (N°1 screen) by entering the correct password (See 10.2.1 chapter)
- Pressing **UP** and **DOWN** select **Reset system** screen (1.11 screen).
- Press **ENTER** to confirm.
- The program will reset and move to valve position screen (N°7 screen)

1.11

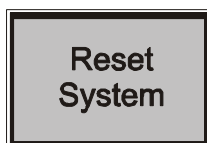

10.2.1.12 Activate battery (1.12 screen)

This menu allows to activate the battery of the electronic switching and signalling unit.



When actuator is not powered, the battery supplies the electric energy to the electronic boards in order to keep and to detect any change of the valve position (%).

When battery is NO activated and has no energy, valve position settings (0%) and (100%) are loosen. (See ¡Error! No se encuentra el origen de la referencia. chapter). Before the start-up process, battery must be activated.

Process:

- Enter in the **Settings** (N°1 screen) by entering the correct password (See 10.2.1 chapter)
- Pressing **UP** and **DOWN** select **Activate battery** screen (1.12 screen).
- Press **ENTER** to confirm.
- A OK.message screen will appear. The program will move to valve position screen (N°7 screen)

1.12

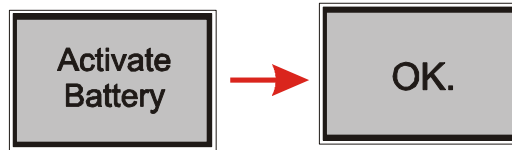

10.2.1.13 Deactivate battery (1.13 screen)

This menu allows to deactivate the battery of electronic switching and signalling unit.



When actuator is stored for long-time periods, and NO-settings have been made in facilities (Valve manufacturer or distributor, when actuator are supplied mounted on valves), battery can be deactivated in order to avoid energy consumption.

Notice that valve position only can be registered when actuator has the battery activated (See 10.2.1.12 chapter).

Process:

- Enter in the **Settings** (N°1 screen) by entering the correct password (See 10.2.1 chapter)
- Pressing **UP** and **DOWN** select **Deactivate battery** screen (1.13 screen).
- Press **ENTER** to confirm.
- A OK.message screen will appear. The program will move to valve position screen (N°7 screen)

1.13

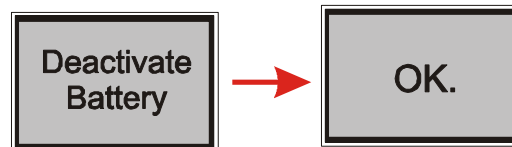

10.2.1.14 Firmware Version and LCD Contrast (1.14 screen)

This menu permits to know the version of the firmware and adjust the level of contrast of the display. Process:

- Enter in the **Settings** (N°1 screen) by entering the correct password (See 10.2.1 chapter)
- Pressing **UP** and **DOWN** select **FW: 05.00 Contrast** screen (1.14 screen).
- Press **ENTER** change the level of contrast.
- Pressing **UP** and **DOWN** select a new value of contrast
- Press **ENTER** again to confirm the new value



10.2.2 Actuator serial number screen (N°2 screen)

This screen displays the actuator serial number.

This serial number must be the same as serial number marked on actuator nameplates

2

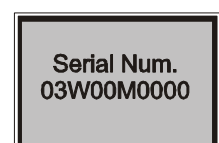

10.2.3 Datalogger: Operational data screen (N°3 screen)

This menu permits to access to actuator datalogger.

- Opening operations: Number of times that 100% open position (Valve fully opened) is reached.
- Closing operations: Number of times that 0% open position (Valve fully closed) is reached.
- Open torque faults: Number of times that max torque value set in opening direction is reached.
- Closing cycles: Number of times that max torque value set in closing direction is reached.
- Thermal faults: Number of times that motor thermal protection relay is activated.
- Number of cycles: Number of full strokes done (open-close-open)

3

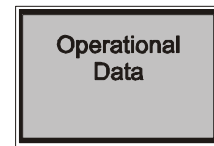

Process:

- In main menu, by pressing **UP** and **DOWN** pushbuttons, enter in the **Operational Data** screen (N°3 screen). Press **ENTER** to confirm
- Pressing **UP** and **DOWN** move to different datalogger screens.
- Finally, press **C** to cancel and escape and returns to main menu.

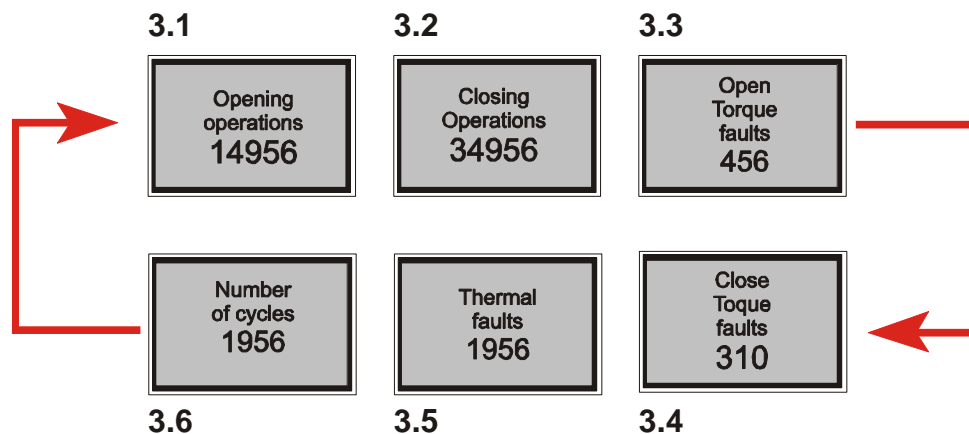

10.2.4 Outputs (N°4 screen)

This screen indicates the real status of the electronic switching and signalling unit relays: There are 5 relays as standard, and up to 12 relays (Option), see 4.8.5, ¡Error! No se encuentra el origen de la referencia. and 10.2.1.8 chapters. See actuator terminal plan to confirm RELAYS available as external indication. The screen shows the 12 relay (logical) information.

4

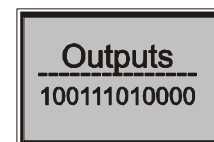

- 0: It means that condition of the relay is NOT activated/achieved.**
- 1: It means that relay condition is activated/achieved.**

Notice that **0** and **1** are logical values of the condition; they do not depend on RELAY configuration (NO or NC). If RELAY 1 is configured as "Reached position: Open", in middle position, the first code (RELAY1) will be **0** (Condition not achieved), once the valve position is 100%, the first code (RELAY1) will be **1**.

10.2.5 Torque and position screens (N°5, N°6 and N°7 screens)

The real valve position and/or actuator output torque indication is displayed in N°5, N°6 and N°7 screens. Indication is given by % value and/or bar status indication.

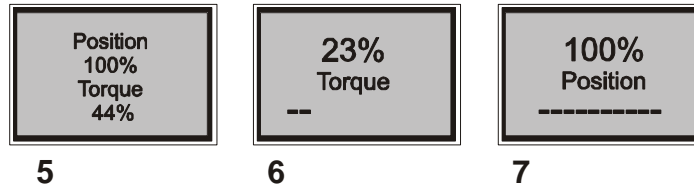

NOTES:

- For Position indication: Out of 0% and 100% valve positions: The electronic switching and signalling unit will check and measure the valve position but indication will be rounded to:
 - 0% for valve positions lower than 0%
 - 100% indication for valve positions higher than valve fully open position (100%)
- In “low energy mode” (When there is NOT power supply coming to the centronik unit and the electronic switching and signalling unit is supply by the battery energy) only position indication is updated and measured (See). Torque system is de-activated.

10.3 CENTRONIK setting procedure (only Modulating and On-Off with display units)



In order to access to this “program mode” is necessary to switch the centronik selector in LOCAL mode and introduce the correct PASSWORD.

All the setting functions are stored in a non-volatile memory in the CENTRONIK unit. The front panel enables the user to view all the functions via the display, and change it, when required. Notice that there is not a “restore function” when changes are made.

For **on-off with display** and **modulating** duties centronik units, by mean of the program mode it is possible to select and configure the centronik parameters, functions and features for such duties, in those cases, the setting procedure include the following functions:

- Control input signal
- Polarity
- Control input and TPS setting
- Deadband
- Rest time
- Close tightly
- Valve opening curves
- Zero and span for Control input and TPS
- Autolearn
- Digital outputs
- Operation mode Emergency Shut Down
- Blinker
- Data logging
- Password
- Inching mode
- Stepping mode



The setting procedure (See figure on 10 chapter) must be followed in order to adjust/set correctly the Centronik Unit: DIP-switches, Limit switches and optional elements must be set before!

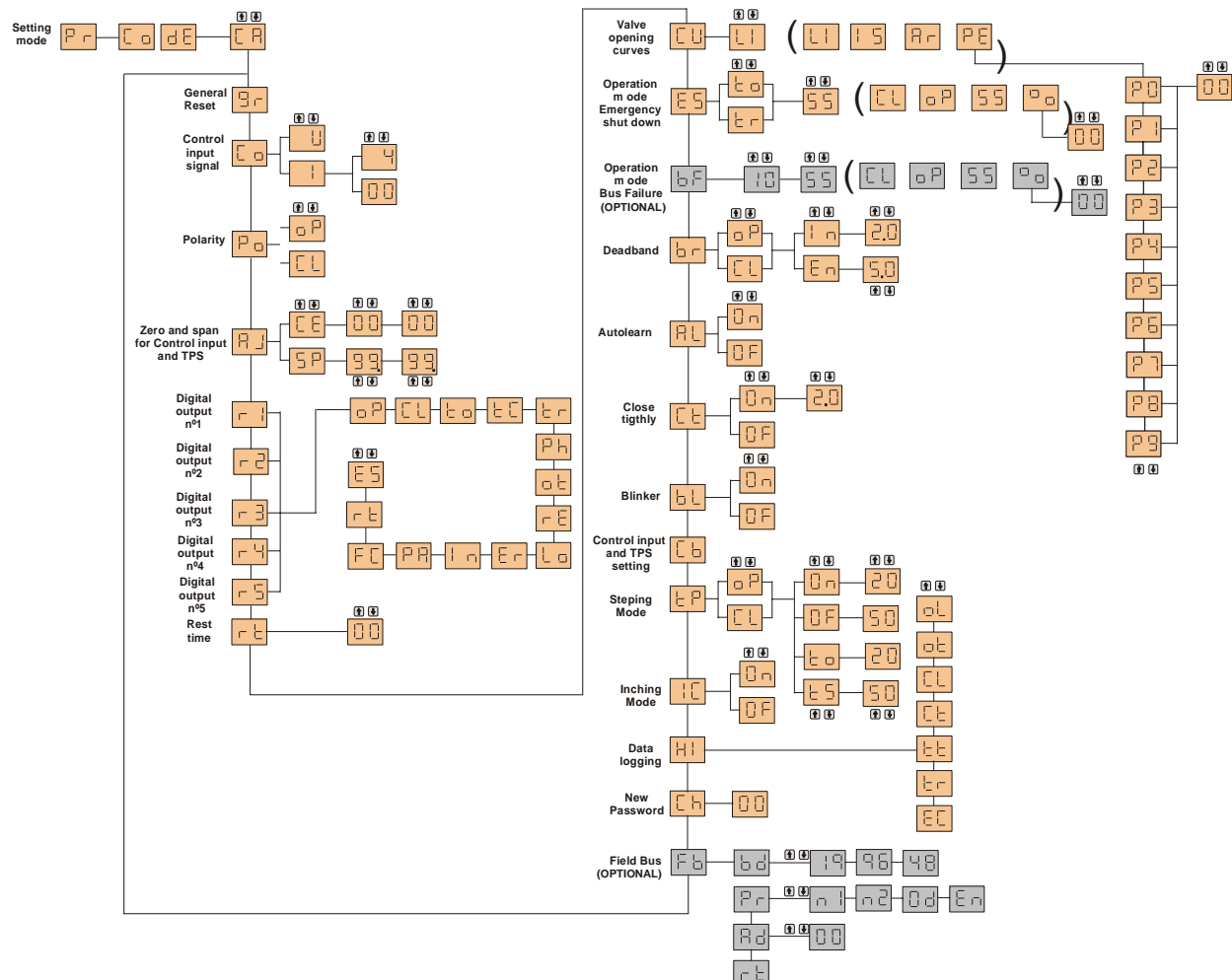













10.3.1 Access to program mode – Password

In order to access to this “program mode” is necessary to switch the centronik selector in LOCAL mode and introduce the correct PASSWORD.

The factory set (default) password is “CA”.

Procedure:













- Press the  key during 3 seconds.
- The display will change to .
- Press the  key.
- The display will change to .
- Press the  key.
- The display will change to .
- Use the  or  keys to scroll through the available password 00-FF (hexadecimal).
- With the correct password display press the  key.
- If the password is incorrect, display will change to . Press the  key and enter the correct password.
- In order to return to the valve position display there are 2 ways: Press the  key or select OFF Control using the selector.

10.3.2 Control input signal (only in Modulating duty)









The modulating duty is a position controller. It compares the input signal and the position transmitter (TPS). The actuator then runs in direction OPEN or CLOSE, subject to the deviation detected. The control input signal is an analogue signal programmed as 0-20mA, 4-20mA or 0-5V.

The control input signal is factory standard 4-20mA.

Procedure:

- Enter in the setting mode (chapter 0)
- Press the  or  key to select the Control input signal menu .
- Press the  key.
- The display will change to .
- Use the  or  keys to scroll through the available password 00-FF (hexadecimal). The password will only be provided if necessary. Consult CENTORK.
- With the correct password display press the  key.
- Press the  key.
- Press the  or  key to select the Control input mode:
 Voltage control input  Current control input

Note: Voltage control is an optional control device.

- With the selected mode press the  key.
- Press the  key.
- Press the  or  key to select the Control input range in case of Current control input:
 4-20mA  0-20mA
- With the selected range press the  key.
- Press the  key.

10.3.3 Polarity (only in Modulating duty)

The polarity permit to reverse the control input (or set position) with the actual position comparison.

The Polarity is factory standard CLOSE.

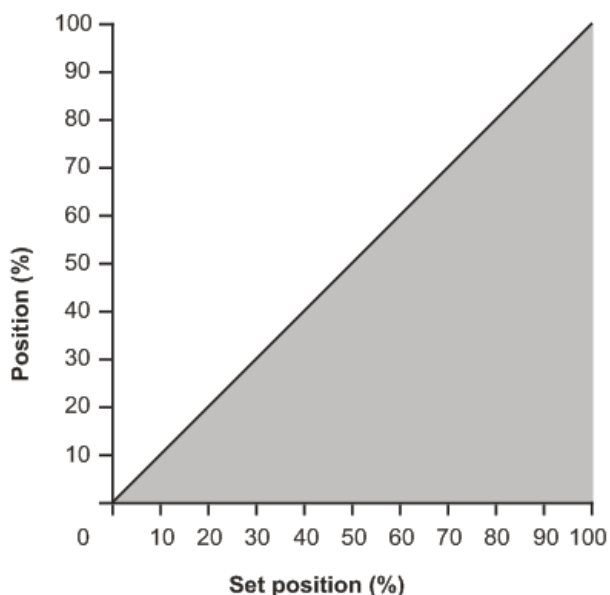



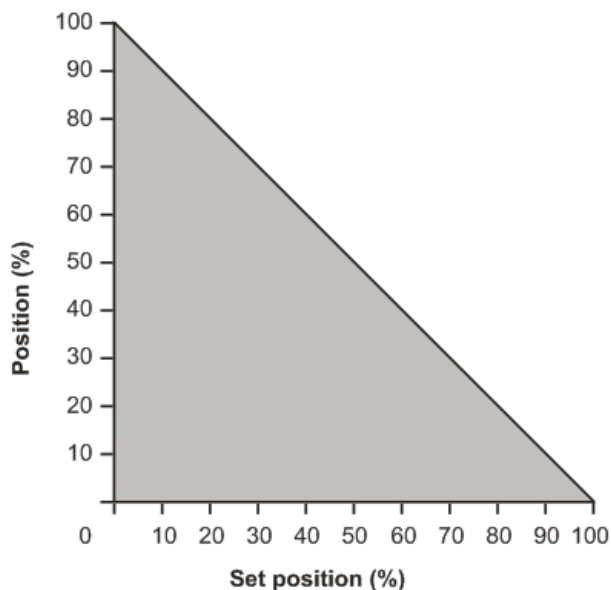







Minimal control input for CLOSE



Minimal control input for OPEN

Procedure:

- Enter in the setting mode (chapter 0)
- Press the  or  key to select the Polarity menu .
- Press the  key.
- Press the  or  key to select the Polarity mode:

 Minimal control input for CLOSE	 Minimal control input for OPEN
---	--
- With the selected polarity press the  key.
- Press the  key.

10.3.4 Zero and span for Control input and TPS –feedback signal- (only in Modulating duty)

This function enables the control input range (zero, span) to be fitted to the valve stroke and this one to be limited to a given MIN (zero) and MAX (span) percentage. This section is also useful for programming the split-range working mode. Split range allows the adaptation of the positioner to control input ranges which are for example necessary to individually control several actuators with the same control input signal. Typical values for two actuators are 0-10mA and 10-20mA.

The zero for Control input and TPS is factory standard 0%(00). The span for Control input and TPS is factory standard 100% (99.).

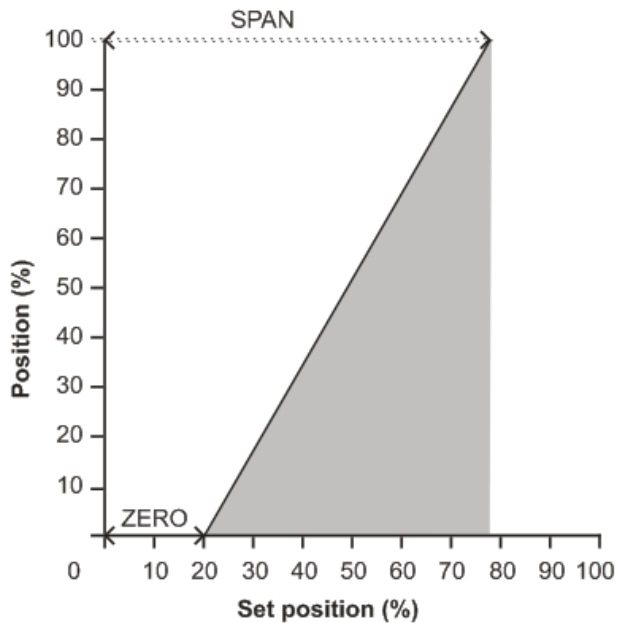



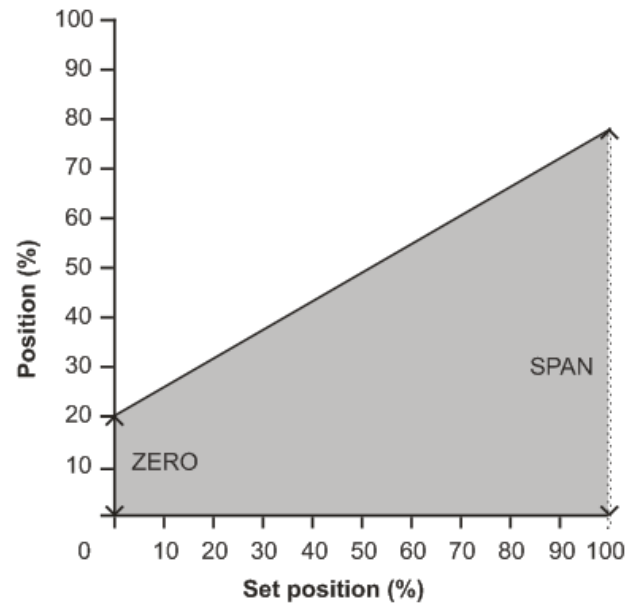





















Zero and span for Set position (Control input)



Zero and span for TPS (position transmitter)

Procedure:

- Enter in the setting mode (chapter 0)
- Press the  or  key to select the zero and span menu .
- Press the  key.
- The display will change to .
- Press the  key.
- Press the  or  key to select the zero for Control input.
- With the selected value press the  key.
- Press the  key.
- Press the  or  key to select the zero for TPS.
- With the selected value press the  key.
- Press the  key.
- The display will change to .
- Press the  key.
- Press the  or  key to select the span for Control input.
- With the selected value press the  key.
- Press the  key.
- Press the  or  key to select the span for TPS.
- With the selected value press the  key.
- Press the  key.

10.3.5 Outputs signals (Digital or relays outputs)





The digital outputs or Relay outputs indicate the actuator state. Five digital outputs are available and programmable. See Appendix for more details.

Digital outputs R1, R2, R3, R4 and R5 may each be set to trip for the desired function.

The digital outputs is factory standard:



r1 = **oP** **r2** = **CL** **r3** = **ot** **r4** = **rt** **r5** = **tr**

Procedure:

- Enter in the setting mode (chapter 0)
- Press the  or  key to select the digital outputs menu **r1**.
- Press the  key.
- Press the  or  key to select the required function:

oP Valve OPEN	Er Anomaly
CL Valve CLOSE	rE Remote selected
to Overtorque reached in OPEN	Lo Local selected
tC Overtorque reached in CLOSE	in Intermediate position
tr Motor protection tripped	PA Position reached (Only in Modulating duty)
Ph Lost phase (only for 3 phases systems)	FC Command signal failure (Only in Modulating duty)
ot Overtorque	rt Rest time
	ES ESD signal (only in Modulating duty and ON/OFF duty with position display)

Anomaly: Motor protection tripped, limit or torque switch fault, movement fault or lost phase.

- With the selected function press the  key.
- Press the  key.

The procedure for setting up digital outputs R2, R3, R4 and R5 are the same as those shown for R1.







10.3.6 Rest time

The rest time is the time after a reach position or OPEN/CLOSE/STOP action that other changes in the nominal value or CLOSE/OPEN action are ignored by the Centronik unit in order to filter major fluctuations within the nominal value and to reduce number of start.

The Rest time prevents the operation to a new nominal position or OPEN/CLOSE action within a predetermine time.

The rest time is factory standard 0s.

Procedure:

- Enter in the setting mode (chapter 0)
- Press the  or  key to select the Rest time menu **rt**.
- Press the  key.
- Press the  or  key to select between **00** and **60** s.
- With the selected Rest time value press the  key.
- Press the  key.

Note: LEDs 1, 2 and 3 light yellow when the Centronik unit execute the rest time



CAUTION: It must be ensured via the control that the maximum permissible number of starts of the actuator is not exceeded. This can be achieved by setting the rest time to a sufficiently high enough value.







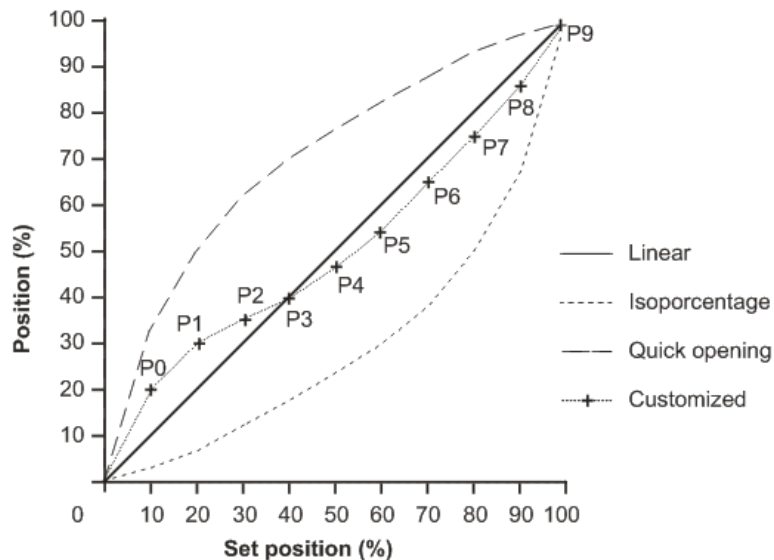







10.3.7 Valve opening curves (only in Modulating duty)

This function enables a transmission characteristic curve with regard to the desired value of set position (Control input) and valve stroke for correction of the flow or operating curve to be chosen.





The Valve opening curves is factory standard Linear.



Procedure:

- Enter in the setting mode (chapter 0)
- Press the  or  key to select the valve opening curves menu .
- Press the  key.
- Press the  or  key to select the valve opening curve required:
 -  Linear opening curve
 -  Isopercentage opening curve
 -  Quick opening curve
 -  Customized opening curve
- With the selected valve opening curve press the  key.
- Press the  key.
- If the customized opening curve is selected, press the  or  key to select the valve opening point (P0 to P9.).

Point	P0	P1	P2	P3	P4	P5	P6	P7	P8	P9
Control input (%)	10	20	30	40	50	60	70	80	90	100
Position required (%)										







- Press the  key.
- With the selected point value press the  key.
- Press the  key.
- Repeat this procedure for each valve opening point (P0 to P9.)
- In order to return to previous menu press the  key.







10.3.8 Operation mode ESD (only in Modulating duty and ON/OFF duty with position display)











In remote mode, an “Emergency Shut Down” signal applied to the actuator will override any existing or applied remote control signal. ESD ignore all securities except the override setting (motor thermostat or torque limit switches).

The factory standard under an active signal is “standstill” position considering motor thermostat.

Procedure:

- Enter in the setting mode (chapter 0)
- Press the  or  key to select the ESD menu .
- Press the  key.
- Press the  or  key to select the required ESD override setting:

 Motor thermostat	 Torque limit switches
--	---
- With the selected ESD override press the  key.
- Press the  key.
- Press the  or  key to select the required ESD action:

 OPEN on ESD	 “Standstill” on ESD
 CLOSE on ESD	 Reach the ESD desired position (only in Modulating duty).
- With the selected ESD action press the  key.
- Press the  key.
- In case of  action, Use the  or  keys to scroll through the available desired position 00-100.
- With the selected value press the  key.
- Press the  key.

10.3.9 Deadband (only in Modulating duty)

There are two deadbands for each operation sense (opening and closing), the outer deadband and the inner deadband:







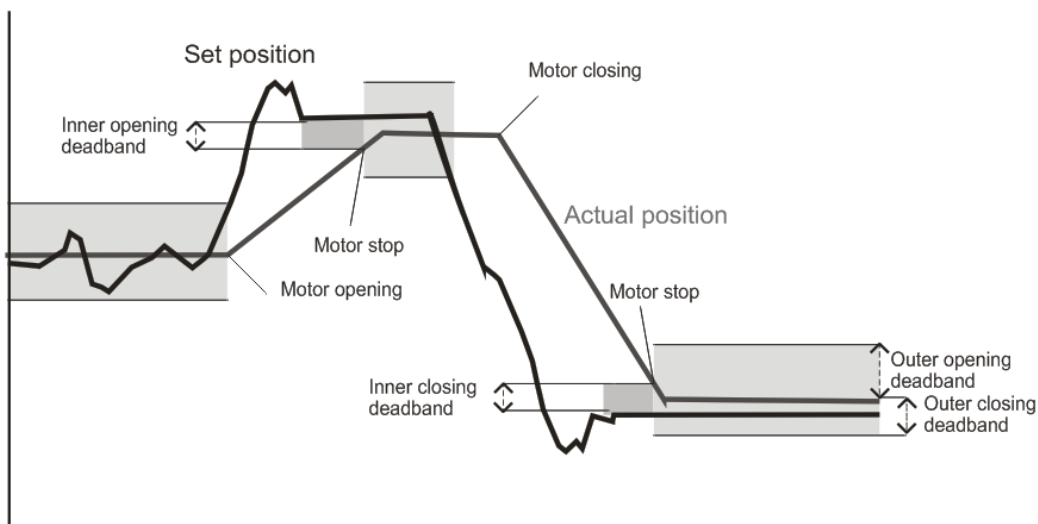











- The outer deadband determines the switching-on point of the actuator.
- The inner deadband determines the switching-off point of the actuator.

The deadband is factory standard 2% for inner deadbands and 5% for outer deadbands.

If the Autolearn menu is activated (ON), it is not necessary to adjust the deadband values.



Procedure:

- Enter in the setting mode (chapter 0)
- Press the  or  key to select the Deadband menu .
- Press the  key.
- Press the  or  key to select between Opening  and Closing  deadbands.
- Press the  key.
- Press the  or  key to select between Inner  or Outer  deadbands.
- Press the  key.
- Press the  or  key to change the value for the selected deadband between 0,5% and 2,0% for the inner deadband and between 1,0% and 5,0% for the outer deadband in 0,5% step.
- With the selected deadband value press the  key.
- Press the  key.
- In order to return to previous menu press the  key.













CAUTION: Outer deadbands must be greater than inner deadband. If the actuator hunts or responds unnecessarily to a fluctuating set position signal (control input) the deadband must be increased. If more accurate control is required the deadband may be decreased.

10.3.10 Autolearn (only in Modulating duty)

An automatic adaptation of the deadbands is suitable with Autolearn function.

The Autolearn is factory standard OFF (deactivated).

Procedure:

- Enter in the setting mode (chapter 0)
- Press the  or  key to select the autolearn menu .
- Press the  key.
- Press the  or  key to select between  (autolearn activated) or  (autolearn deactivated).
- With the selected activation/deactivation press the  key.
- Press the  key.











10.3.11 Close tightly (only in Modulating duty)





Close tightly ensures that the actuator opens and closes fully, when activated, it ignores the death bands, near to end positions.

If the nominal value (control input) 0/4 mA or 20 mA for the approaching of the end positions is not reached, a “close tightly” tolerance for the nominal value can be set within the range of the end positions. If the tolerance is exceeded or not reached, the actuator continues the operation until the full end position has been reached.

The close tightly is factory standard OFF (deactivated).

Procedure:

- Enter in the setting mode (chapter 0)
- Press the  or  key to select the Close tightly menu .
- Press the  key.
- Press the  or  key to select between  (close tightly activated) or  (close tightly deactivated).
- With the selected activation/deactivation press the  key.
- Press the  key.











- If close tightly is activated (ON), press the  or  key to select the close tightly range between 0.5% and 2% in 0,5% step.
- With the selected value press the  key.
- Press the  key.

10.3.12 Blinker (only in Modulating duty and ON/OFF duty with position display)

Blinker transmitter allows to detect movement of the actuator. Blinker detection can be switched on or off. If the detection is switched off, the movement detection is suitable with the position transmitter (TPS).

The blinker is factory standard ON (activated).

Procedure:

- Enter in the setting mode (chapter 0)
- Press the  or  key to select the blinker menu .
- Press the  key.
- Press the  or  key to select between  (blinker activated) or  (blinker deactivated).
- With the selected activation/deactivation press the  key.
- Press the  key.

10.3.13 Calibration of the CENTRONIK unit







This step/instruction is mandatory for a correct operation of CENTRONIK modulating and on/off with display duties.



This function calibrates the centronik unit with the control INPUT signal (user, 20mA) and valve position –feedback signal- given by the electronic position transmitter TPS (20mA): The set point and the actual position (Centronik unit, 100%). This calibration will ensure a correct operation in Remote mode!

Limit switches and 0/4-20mA transmitter must be set before!

Procedure:











- Before making the calibration, the valve should be brought to the maximum opening position, therefore the TPS should be supplying the maximum current (20mA). For modulating duty, the control input signal should be supplying the maximum current (20mA).
- Enter in the setting mode (chapter 0)
- Press the  or  key to select the Calibration menu .
- Press the  key.
- The display will change to a blinking hexadecimal value.
- Press the  and  key simultaneously to record the calibration. The display will stop blinking.
- Press the  key.

10.3.14 Inching mode (only in ON/OFF duty with position display)

- With **self-retaining operation**, the actuator continues to run as long as the STOP command from the control system (digital input) is not being generated, or any centronik operation condition takes place (Inching mode OFF).
- With **push to run operation (Inching mode)** the actuator continues to run as long as this command from the control system (digital input) remains (Inching mode ON).

The Inching Mode is factory standard OFF (deactivated).

Procedure:

- Enter in the setting mode (chapter 0)
- Press the  or  key to select the Inching mode menu .
- Press the  key.
- Press the  or  key to select between  (push to run) or  (self-retaining).
- With the selected activation/deactivation press the  key.
- Press the  key.

10.3.15 Stepping mode (only in ON/OFF duty with position display))

The stepping mode is used to increase the operating time for the entire or any portion of the valve travel. Different operating times can be realised without using two-speed motors. Start and end of stepping mode as well as ON and OFF time can be programmed individually for the directions OPEN and CLOSE.

The Stepping Mode is factory standard OFF (deactivated):

- | | |
|---------------|---------------|
| • CL-OF: 60%. | • ON-OF: 40%. |
| • CL-ON: 40%. | • ON-ON: 60%. |
| • CL-To: 1s. | • ON-To: 1s. |
| • CL-Ts: 10s. | • ON-Ts: 10s. |

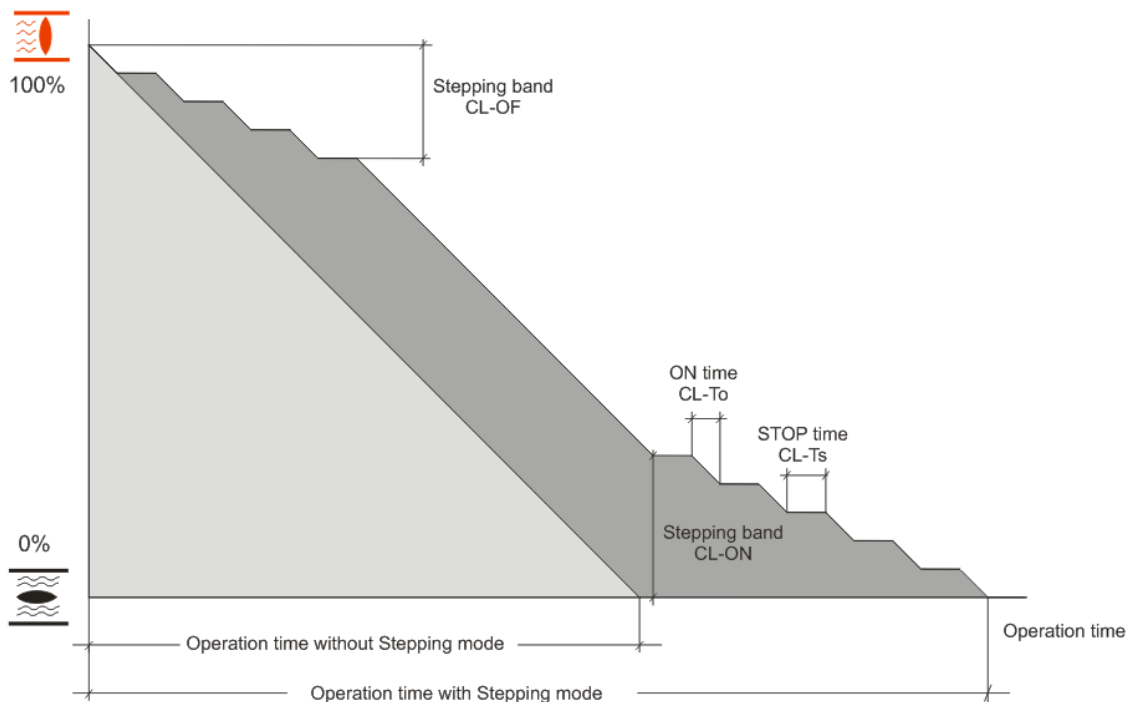



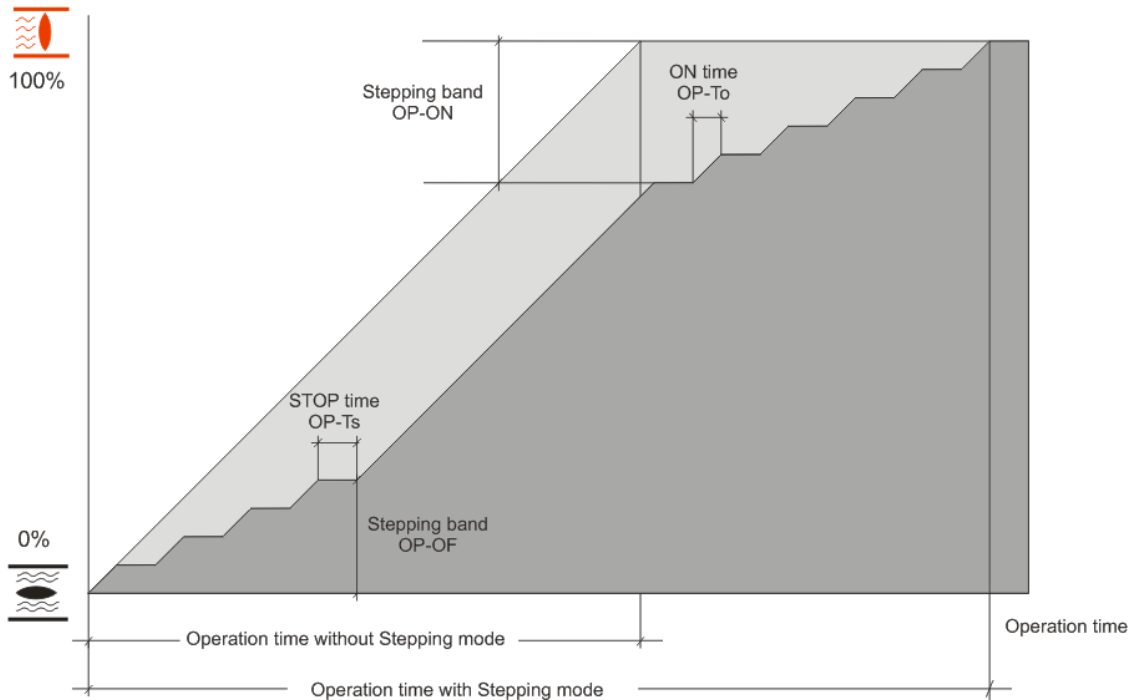























- CL-OF: Direction CLOSE, first stepping operation then normal operation.
- CL-ON: Direction CLOSE, first normal operation then stepping operation.
- CL-To: Running time in direction CLOSE.
- CL-Ts: OFF time in direction CLOSE.



- OP-OF: Direction OPEN, first stepping operation then normal operation.
- OP-ON: Direction OPEN, first normal operation then stepping operation.
- OP-To: Running time in direction OPEN.
- OP-Ts: OFF time in direction OPEN.

Procedure:







- Enter in the setting mode (chapter 0)
- Press the  or  key to select the Stepping mode menu .
- Press the  key.
- Press the  or  key to select between  (stepping mode activated) or  (stepping mode deactivated).
- With the selected activation/deactivation press the  key.
- Press the  or  key to select between Opening  and Closing  bands.
- Press the  key.
- Press the  or  key to select between , ,  y .
- Press the  key.
- Press the  or  key to change the value for the selected parameter (0 to 100% for ON and OF parameters in 1% step and 0 to 60s for to and tS parameters in 1s step).
- With the selected value press the  key.
- Press the  key.
- In order to return to previous menu press the  key.













CAUTION: OP-ON must be greater than OP-OF and CL-OF must be greater than CL-ON.

10.3.16 Centronik data logging







Procedure:

- Enter in the setting mode (chapter 0)
- Press the  or  key to select the data logging menu  .
- Press the  key.
- Press the  or  key to select the data logging required.

	N° of opening operations		Total running hours
	N° of open torque faults		N° of thermal faults
	N° of closing operations		N° of powering
	N° of close torque faults		
- With the selected data logging press the  key.
- As an example, if the Total running hours is 130012, it will display ""(blank),"13","00","12","""(blank),...
- Press the  key.
- In order to return to previous menu press the  key.

10.3.17 New Password

Procedure:

- Enter in the setting mode (chapter 0)
- Press the  or  key to select the Password menu  .
- Press the  key.
- Use the  or  keys to scroll through the desired password 00-FF (hexadecimal).
- Press the  key.



CAUTION: Password changing is a delicate operation. Write it down and keep it safety. In case of missing, contact CENTORK

11 TROUBLE SHOOTING

The following instructions are offered for the most common difficulties encountered during installation and start-up.

11.1 Front panel indication fault

- **L1 and L3 yellow blinking:**
 - **Cause:** Limit switch failure. Both limit switches are activated or an opposite limit switch is activated during a CLOSE or OPEN operation.
 - **Solution:**
 - Check the valve end positions 0%-100% limit switch setting (10.2.1.8, 10.2.1.1 and 10.2.1.2 chapters), valve and actuator sense of rotation and SW4 setting (10.1.3 chapter).
 - Check that battery is activated and battery energy level is correct as well (9.4 chapter)
 - Press **STOP** in centronik frontal panel (LOCAL mode) or **STOP** command (REMOTE mode) to reset the anomaly event (Anomaly acknowledgement).
- **L4 yellow blinking:**
 - **Cause:** Torque switch failure. An opposite limit switch is activated during a CLOSE or OPEN operation.
 - **Solution:**
 - Check valve and actuator sense of rotation and SW4 setting (10.1.3 chapter).
 - Press **STOP** in centronik frontal panel (LOCAL mode) or **STOP** command (REMOTE mode) to reset the anomaly event (Anomaly acknowledgement).
- **L2 yellow:**
 - **Cause:** BLINKER (Movement) fault. During a CLOSE or OPEN operation and after 7 seconds, the status of the blinker transmitter does not change, a Blinker alarm event is activated: That means that there is NOT motion detected by the electronic switching and signalling unit.
 - **Solutions:**
 - Check if valve can be operated manually (Valve might be jammed), also check if torque relays trip
 - Check and verify that valve position sensor is correct. This can be done by re-adjusting the valve end positions 0%-100% (Limits) according to 10.2.1.1 and 10.2.1.2 chapters.
 - Press **STOP** in centronik frontal panel (LOCAL mode) or **STOP** command (REMOTE mode) to reset the anomaly event (Anomaly acknowledgement).
- **L2 red or red blinking:**
 - **Cause:** Motor thermal protection tripped. Duty service exceeds.
 - **Solution:**
 - Check that the valve spindle is correctly lubricated.
 - Verify that actuator is correctly sized for valve torque/forces requirements.
 - It must be ensured via the control that the duty service of the actuator is not exceeded. This can be achieved by setting the rest time to a sufficiently high enough value (See 10.3.6 chapter) and to increase the deadbands values (See 10.3.9 chapter).
 - Press **STOP** in centronik frontal panel (LOCAL mode) or **STOP** command (REMOTE mode) to reset the anomaly event (Anomaly acknowledgement).
- **L5 red:**
 - **Cause:** Lost Phase.
 - **Solution:** Check if the 3 phases power supply are correct, in actuator user terminals 1-2-3.
- **L5 yellow:**
 - **Cause:** Inverse phase connection. The Centronik unit includes a 3 phases correction system therefore this indication is not an alarm/fault. This is not an anomaly, it is a warning message. The centronik phase-sequence discriminator circuit will correct them automatically, but the LED will turn on in yellow colour.
 - **Solution:** Invert two phases, the yellow colour of LED5 will change to green colour.

- **L1, L2 and L3 yellow: Rest time executing (Chapter 10.3.6)**
- **L2 green: Stepping mode activated and OFF time executing (Chapter 10.3.15).**
- **All LEDs switch off:**
 - **Cause:** Power supply fault, fuse burned or display board disconnected.
 - **Solution:** Check if the power supply is correct, fuses state and display board connection.

11.2 Actuator does not operate in LOCAL mode

- Check front panel indication fault.
- Check SW1, SW2 and SW3 setting (Chapter 10.1.1).
- Check the connection of the cable between the front panel board and the CPU board (See 5.5 chapter)

11.3 Actuator does not operate correctly in REMOTE mode

- Check front panel indication fault.
- Check SW8 setting (Chapter 10.1.5).
- In case of analogue input control (Modulating duty), check the correct connection, the SW6 setting (Chapter 10.1.4), and the setting procedure (Chapter 10.2). Check if ESD is not activated.
- In case of parallel control (ON/OFF duty and ON/OFF with display duty), check the correct connection. Check if ESD is not activated.

11.4 Actuator turn in the wrong sense

- Check the SW4 setting (Chapter 10.1.2).

11.5 Centronik output signals does not work

- Check the output signals setting (Chapter 10.3.5).
- Check the correct connection and wiring (6 chapter), and technical parameters on annexe.

12 MAINTENANCE

CAUTION: Safety instructions on chapter 2 must be observed.

CENTORK actuators are supplied greased from the factory for their lifetime, needing practically no maintenance.

12.1 Commissioning, after the star-up

- Check for damage on paint caused by transport, assembly or handling and repair the damage carefully in order to ensure complete protection against corrosion.
- **Make sure that all the o-ring seals are correctly mounted and that the cable glands are firmly fastened, and protection plug for cable entry not used have been replaced with metallic protection plug sealed with PTFE tape, in order to ensure the IP67, IP68 protection.**
- Check that switching and signalling cover and connection cover screws are correctly fastened.
- **Check the correct tightening of the bolts between the actuator and the valve.**
- Check the correct greasing of the gear housing.
- The most important condition for reliable service of the CENTORK actuators is the fact of having carried out a correct commissioning and set-up procedure.

12.2 Maintenance for service

CENTORK recommends for a preventive maintenance programme. Approximately 3 months after commissioning and then every 9/12 months:

- **Check the correct tightening of the bolts between the actuator and the valve.**
- **Take advantage of each revision to check the proper tightening of the covers, of the handwheel lock and the external electric connection.**
- **Check cable entries.**
- **Visual inspection inside of switching and signalling, and electrical compartments.**
- Contact with valve manufacturer in order to know about maintenance routines of valve.
- In the event of infrequent service, perform a test run every 6 months in order to ensure the availability of service of the actuator.

12.3 Electric actuator's service life

- Electric actuator service life is rated to 20.000 cycles.
- Each cycle is formed by an opening manoeuvre (Valve close position to valve open position) and a closing manoeuvre (Valve open position to valve close position).
- 50 turns has been considered as standard valve stroke reference.

12.4 Centronik fuses replacement

- The Centronik unit presents 2 fuses. In order to replace the fuses SAFETY INSTRUCTION must be observed (Chapter 2).
- With power off, open the electrical cover and the explosion proof cover.
- Open the fuse holders and replace the fuses according to the table below.

Electric actuator with Terminals connection

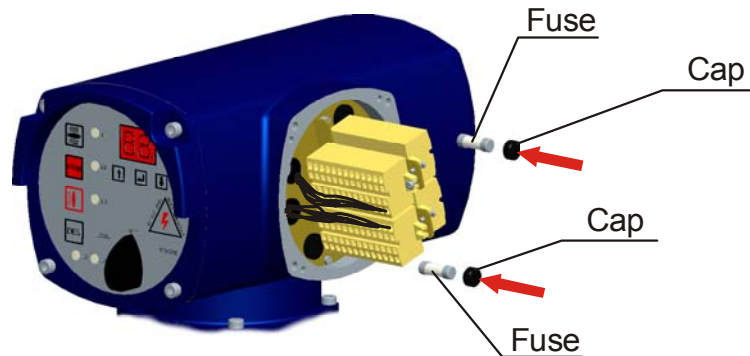

Electric actuator with Plug-socket connectors with screws

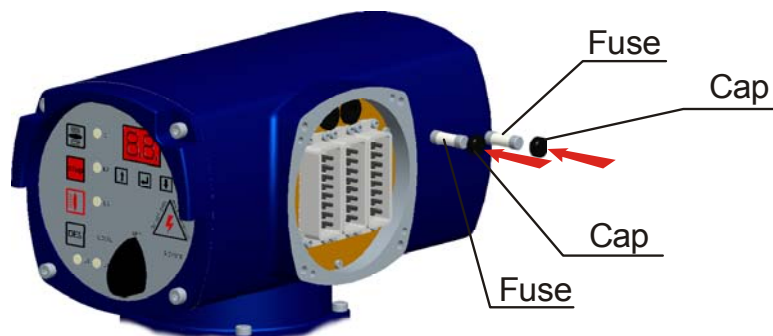

TENSION	CARACT. FUSE
24VDC	5A (5X20mm)
110/120VAC	2A (5X20mm)
220/230VAC	1A (5X20mm)

TENSION	CARACT. FUSE
380 to 440 VAC	500mA (6.3X32mm)
460 to 600 VAC	250mA (6.3X32mm)

- Once you have checked that the fuse holders have been properly carried out and the state of the o-ring seal, close the explosion proof cover. Fasten the 4 screws crosswise.
- Close the electrical cover and check the proper connection, the state of the o-ring seal and the proper installation of the latter, greasing it slightly. Fasten the 4 screws crosswise.

12.5 Replacement of the electronic switching and signalling battery

Expected life of the electronic switching and signalling **battery** is 5 years, as average; It depends on external factors. CENTORK recommend the battery replacement every 4 years. Battery, as spare part, must be included in any user maintenance routine plan.

! Only CENTORK original batteries must be employed. CENTORK cannot warranty a correct actuator operation with other battery types and models.

For battery replacement, check and observe the SAFETY instructions described in 2 chapter. For this operation actuator must be disconnected from main power supply.

! During the battery replacement actuator must not be operated . Once a new battery is mounted on the electronic switching and signalling unit, it is necessary to adjust the valve ends positions -Valve fully open - 100% and -valve fully closed- 0% (See 10.2.1.1 and 10.2.1.2 chapters), and verify main settings before re-start the actuator operation again.

Procedure:

- Access to battery: Loose the 4 M6 bolt of the electronic switching and signalling cover and open the cover carefully in order to avoid any damage on cables/wires. DO not disconnect them!. Remove the old battery.
- Replace the battery by new one CENTORK spare battery. Check the battery correct mounting position (Battery polarity).
- Mount again the electronic switching and signalling frontal panel. Check that:
 - All cables are correctly connected.
 - Cover does NOT trap any cable and/or connector.
 - Check that cover O-ring is not damaged.
 - Tighten and fasten correctly the 4 M6 bolts.

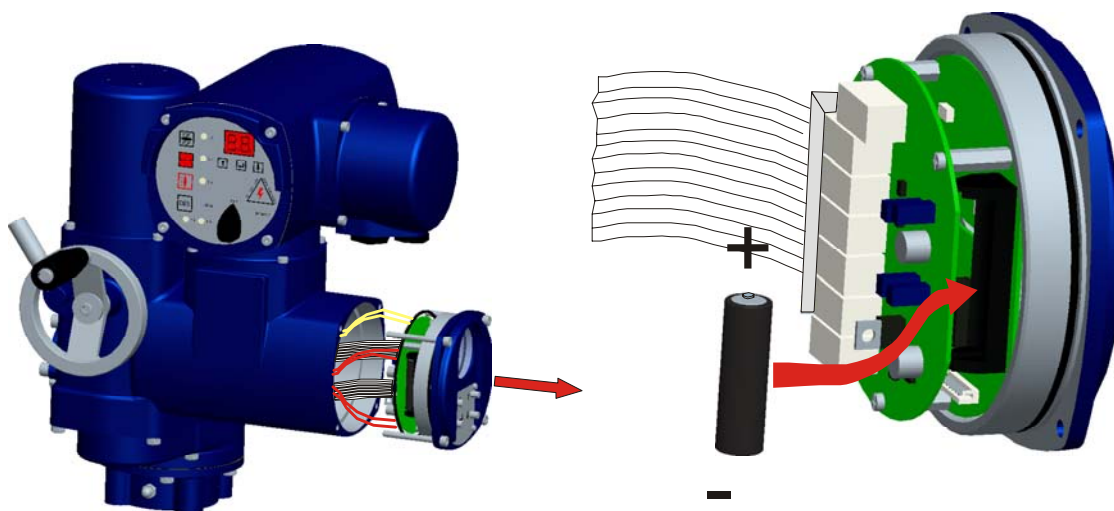

13 TECHNICAL SUPPORT

Each actuator is supplied with a datasheet on A4 format. The following is included:

- The nameplates attached to the actuator.
- Electric actuator datasheet.
- The electric connection diagram for each actuator (also stuck inside the connections cover of the actuator).
- This electric actuator user manual.

For any claim or information request, the SERIAL NUMBER included on this datasheet or on the Electric actuator nameplates should be used.

Electric actuator manufacturer address: See on Manual covers.

14 LIST OF SPARE PARTS

14.1 Actuator unit

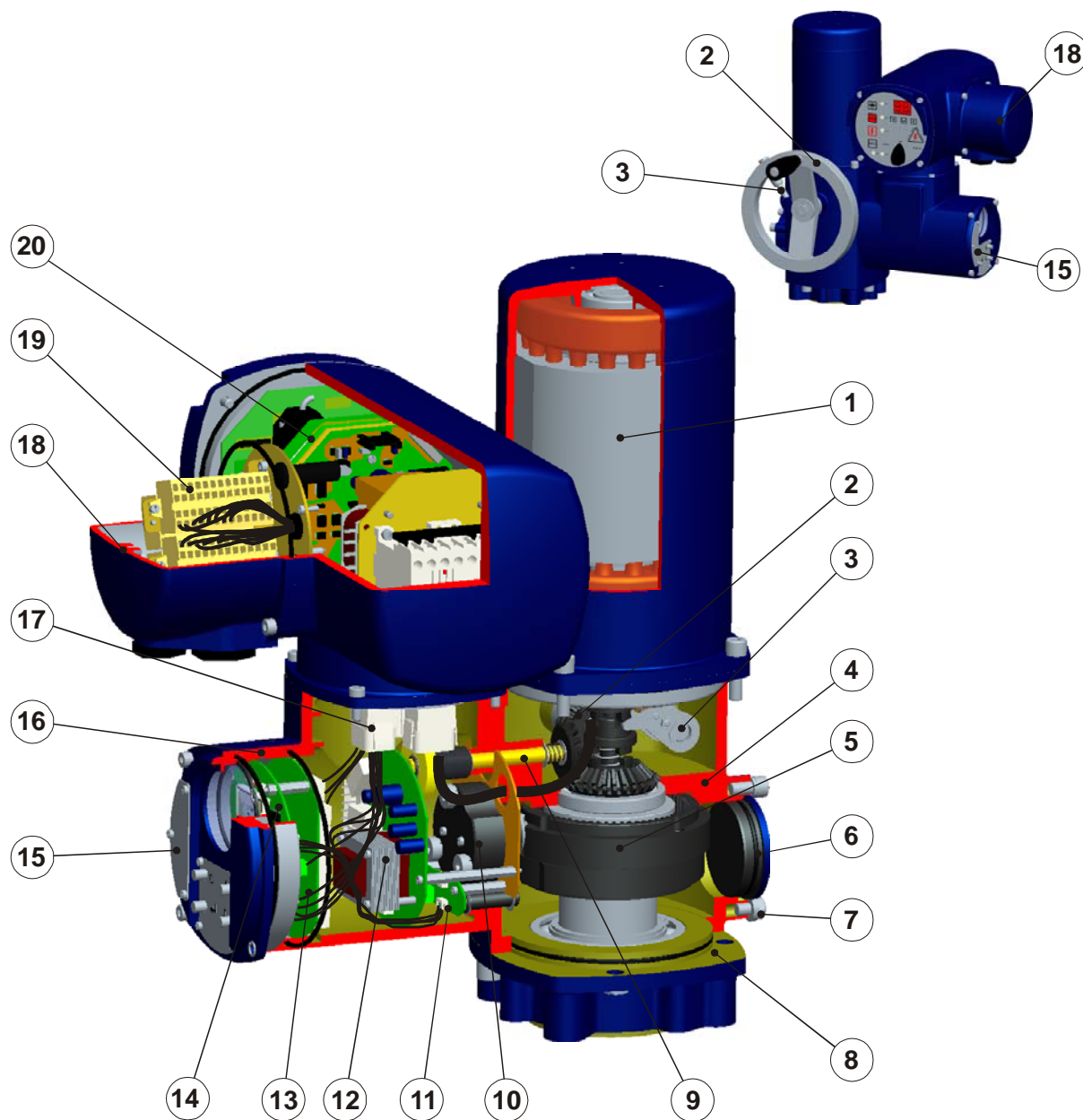

<i>Electric actuators, 462 series</i>					
Mark	Description	QTY	Mark	Description	QTY
1	Electric motor	1	11	Electronic board (Sensors)	1
2	Handwheel and manual shaft subassembly	1	12	Electronic board (Power circuit)	1
3	Override and declutch lever subassembly	1	13	Electronic board (Relay and transmitters)	1
4	Housing	1	14	Electronic board (CPU)	1
5	PTCS planetary subassembly	1	15	Electronic switching and signalling frontal panel	1
6	Cover	1	16	Adaptor	1
7	External ground earth terminal	1	17	Internal connection (Aerial connectors)	1
8	Actuator output flange	1	18	Electric cover	1
9	Motion measuring shaft subassembly	1	19	Terminal block user connector	1
10	Torque sensor	1	20	Centronik unit	1

14.2 Centronik unit

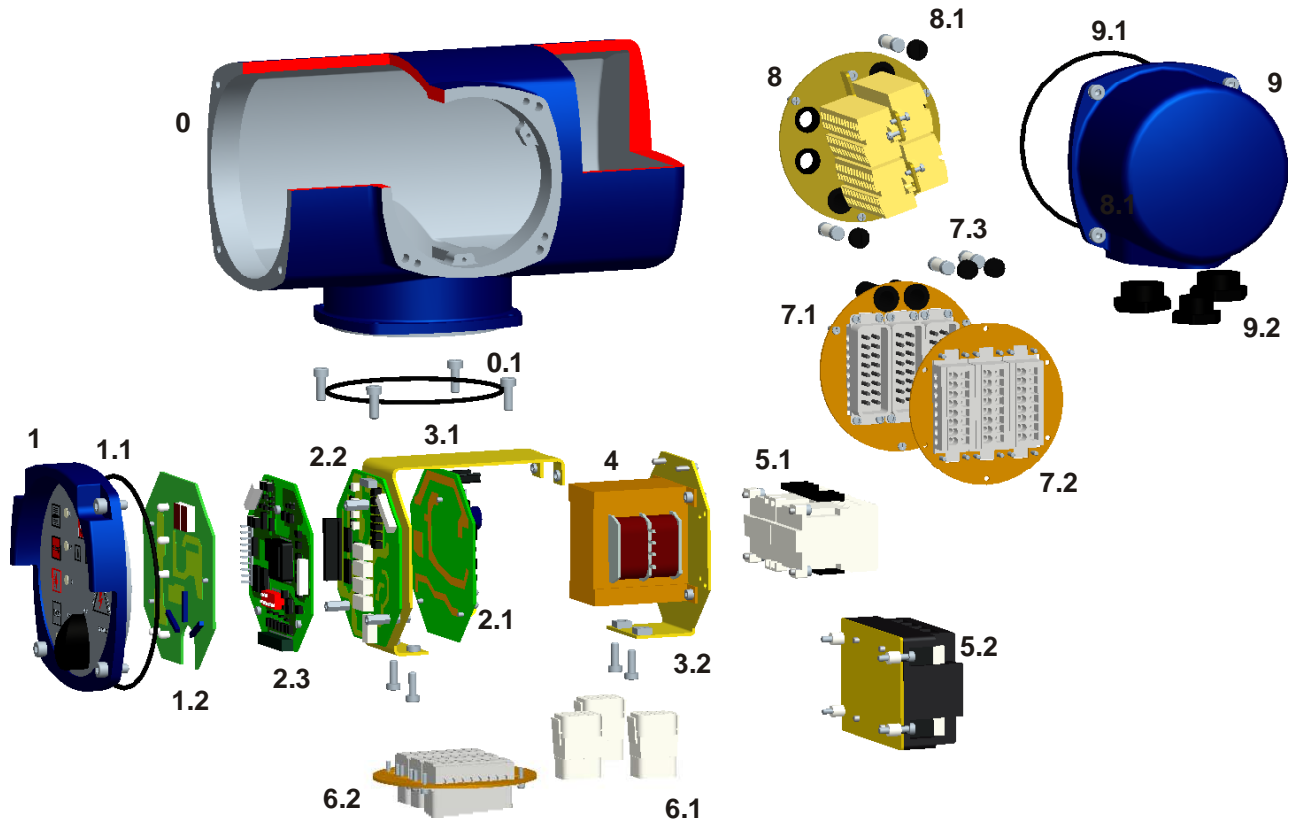

Mark	DESCRIPTION	Mark	DESCRIPTION
0	CENTRONIK MAIN CASE (ENCLOSURE)	5.2	SOLID STATE MOTOR STARTER: TYRISTOR (OPTIONAL)
0.1	O-RING	6.1	INTERNAL CONNECTION (AERIAL)
1	CENTRONIK FRONTAL PANEL	6.2	INTERNAL CONNECTION (PLUG AND SOCKET)
1.1	O-RING	7.1	USER CONNECTION (PLUG AND SOCKET -MALE-)
1.2	ELECTRONIC BOARD (KEYBOARD AND DISPLAY)	7.2	USER CONNECTION (PLUG AND SOCKET -FEMALE-)
2.1	ELECTRONIC BOARD (CPU)	7.3	FUSES
2.2	ELECTRONIC BOARD (I/O)	8.1	USER CONNECTION (TERMINALS)
2.3	ELECTRONIC BOARD (POWER)	8.2	FUSES
3.1	ELECTRONIC SUPPORT	9	ELECTRIC COVER
3.2	TRANSF. AND CONTACTOR SUPPORT	9.1	O-RING
4	TRANSFORMER	9.2	CABLE ENTRIES PROTECTION PLUGS
5.1	CONTACTOR (STARTER)		

APPENDIX: OUTPUT TYPES

OUTPUT TYPE A Size F-07 (ISO 5210)

Disassembly:

- Employing a suitable tool, remove the retaining ring (3), which fixes the removable bronze bush (1).
- Push in order to extract this piece.

Assembly:

- Having machined the removable bush according to valve stem dimensions, refit the drive bus (1) into the output shaft bore, align the keyway (2) in its output shaft shape.
- Refit the retaining ring (3).

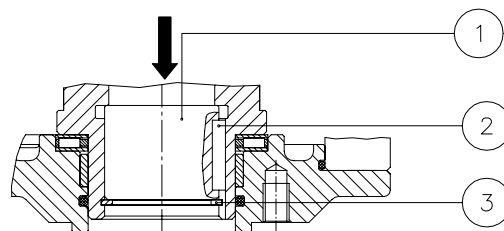

Figure 1

OUTPUT TYPE A Size F-10/F-16/F-25 (ISO 5210)

Disassembly:

- Push and press the removable bronze bush (2) in order to extract the cover (4), axial bearings (3) and removable bronze bush (2)

Assembly:

- Having machined the removable bronze bush according to valve shaft, clean thoroughly this piece. Apply grease on axial bearings and discs (3). Assemble axial disc on removable bush (2), finally insert the cover (4). Check O-rings on cover.
- Apply grease on. Insert the removable bush on output type A base casting unit and output shaft, notice that dog coupling (Tooth) on bushing should match with actuator hollow output shaft (1). Verify O-ring (4).
- For maintenance, grease can be supply through grease nipple (5).

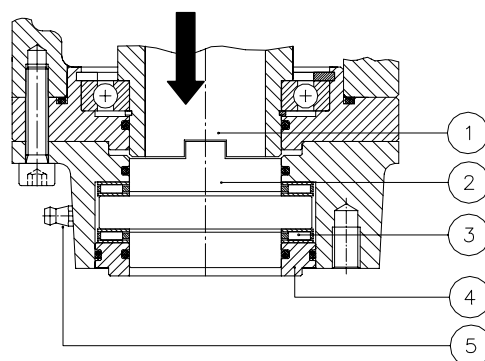

Figure 2

OUTPUT TYPE A Size F-14 (ISO 5210)

Disassembly:

- Remove retaining ring (5) and unscrew the stop ring (4) employing a suitable tool.
- Push and press the removable bronze bush (1) in order to extract it.

Assembly:

- Having machined the removable bush according to valve stem dimensions, refit the drive bus (1) into the output shaft bore (3), align the keyway (2) in its output shaft shape.
- Screw the stop ring (4) employing a suitable tool.
- Refit the retaining ring (5).

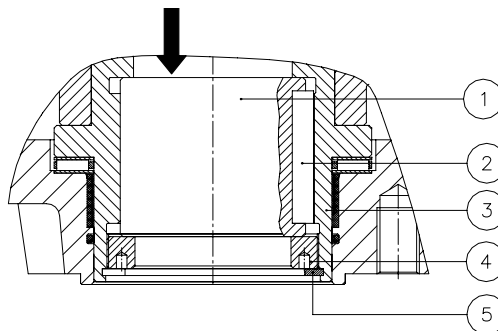

Figure 3

**OUTPUT TYPE B3 Size F-07/F-10/F-14/F-16/F-25
(ISO 5210)**

Disassembly:

- Employing a suitable tool, remove the retaining ring (4), which fixes the removable steel bush (1).
- Push in order to extract this piece.

Assembly:

- Having machined the removable steel bush according to valve stem dimensions, refit the drive bus (1) into the output shaft bore, align the keyway (2) in its output shaft shape.
- Refit the retaining ring (4).

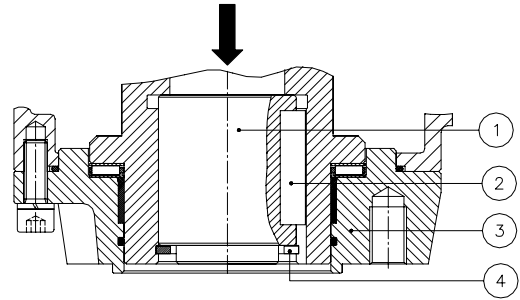

Figure 4

OUTPUT TYPE B0 Size F-10 / F-14

B0 output type is supplied, already machined, according to dimensions published in technical datasheets.

Disassembly:

- Employing a suitable tool, remove the retaining ring (3), which fixes the removable steel bush (1). Removable bush is located inside of output shaft (2).
- Push in order to extract this piece.

Assembly:

- Having machined the removable steel bush according to valve stem dimensions, refit the drive bus (1) into the output shaft bore.
- Refit the retaining ring (3).

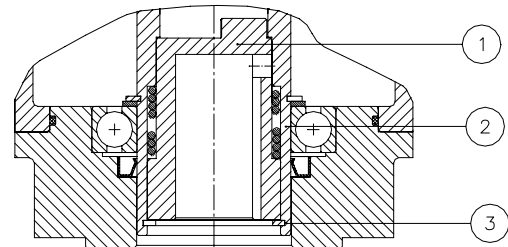



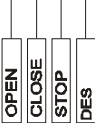

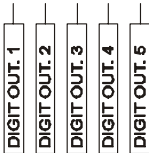

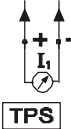
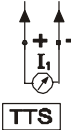

Figure 5

FASTEN BOLTS (CLASS 8.8)

BOLT	FRICTION FACTOR		
	LOW	MEDIUM	HIGH
M4	4.2	6	8
M6	6.2	8.2	10
M8	15	21	24
M10	30	41	48
M12	49	68	85
M14	85	108	130
M16	130	165	200
M18	170	240	280
M20	240	340	410
M30	800	1150	1350
M36	1450	2050	2400

Torque values in N.m
Steel bolts class 8.8

WIRING DIAGRAMS, TERMINAL PLANS, LEGENDS AND SYMBOLS

SYMBOL	DESCRIPTION	TECHNICAL DATA
	<u>M1</u> Electric motor (AC single and three phase)	Main power supply: See Centronik nameplates Main voltage supply tolerance: $\pm 10\%$ Frequency tolerance: $\pm 5\%$
	<u>M1</u> Electric motor (DC)	Main power supply: See Centronik nameplates Main voltage supply tolerance: $\pm 20\%$
	<u>Remote inputs</u> OPEN, CLOSE, STOP (ALARM RESET), UNLOCK remote input signal	
	<u>ESD</u> Emergency Shut Down remote input signal	
	<u>Digital outputs</u> Centronik output signal 24 VDC digital signals.	Programmable digital outputs 24VDC, 100mA max. Setting: ON-OFF duty, see 10.1.2 chapter. ON-OFF duty with display and modulating duty, see 10.3.5 chapter.
	<u>SR1, SR2, SR3, SR4 and SR5</u> Centronik output signal Relay outputs.	Programmable relay outputs SR1 to SR4: 250VAC/24VDC, 5A max. SR5: 250VAC/24VDC, 2A max. Setting: ON-OFF duty, see 10.1.2 chapter. ON-OFF duty with display and modulating duty, see 10.3.5 chapter.
	<u>POSITION./COMMON P.</u> Control input signal	Analogue input 0/4-20mA or 0/5V (0/10V as option) Resistance value: 220 Ω See 6.1.1.2 chapter
	<u>TPS</u> Electronic Position transmitter 0/4-20 mA (Volts signal, optional)	Transmitter powered by the centronik unit. 2-wires :0/4-20 mA. (Optional: Volts signal) Max load.:600 Ohms Accuracy : <1% Setting: See 10.2.1.6 chapter
	<u>TTS</u> Electronic torque transmitter 0/4-20 mA (Volts signal, optional)	Transmitter powered by the centronik unit. 2-wires :0/4-20 mA. (Optional: Volts signal) Max load.:600 Ohms Accuracy : <1% Setting: See 10.2.1.7 chapter.
	<u>REL6, REL7, REL8, REL9, REL10, REL11 and REL12</u> Signalling extra relay.	I _{max} , 250VAC: 10A (cos ϕ =1) I _{max} , 30VDC: 10A (Resistive charge) (Optional, relay for low energy circuits: Gold contact relays) Setting: See 10.2.1.8 chapter

For further technical information, consult CENTORK technical datasheet or contact directly with CENTORK. CENTORK address can be found printed on manual covers.

Others wiring diagrams are available and are included with each actuator provided.



DECLARATION OF CONFORMITY

CENTORK VALVE CONTROL S.L. hereby declares under sole responsibility that the electric actuators, series listed below

**1400. 1401. 1402. 1403. 1404. 1405. 1460. 1461. 1462. 1603. 1464. 1465.
1410. 1411. 1412. 1413. 1414. 1415. 1470. 1471. 1472. 1473. 1474. 1475**

are designed and produced to be installed on industrial valves in compliance with the essential safety requirements of the following directives

*89/336/EC directive: Electromagnetic compatibility
73/23/EC directive: Low-voltage equipment
98/37/EC directive: Mechanical equipment-Machinery.*

Compliance with the Essential health and Safety Requirements has been assured by compliance with:

*ISO 5210: 1.991
ISO 5211: 2.001
EN 292-1: 1.993
EN 292-2: 1.993*

*EN 50081-2:1994
EN 50082-2:1998
EN 61000-4:1999
EN 60204-1: 1.999*

*EN60034-1: 1.998
EN50178: 1.998
DIN VDE 0100: 1.997
DIN VDE 0530: 1982*

Centork actuators covered by this Declaration must not be put into service until the equipment into which they are incorporated, has been declared in conformity with the provisions of the Machinery Directive.

Lezo, 21 de Enero de 2.008



Francisco Lazcano
-General manager-

(Centro fabricación y sede social)
Centork Valve Control S.L.
Pol ind. 110 Txatxamendi 24-26
Lezo 20.100 SPAIN

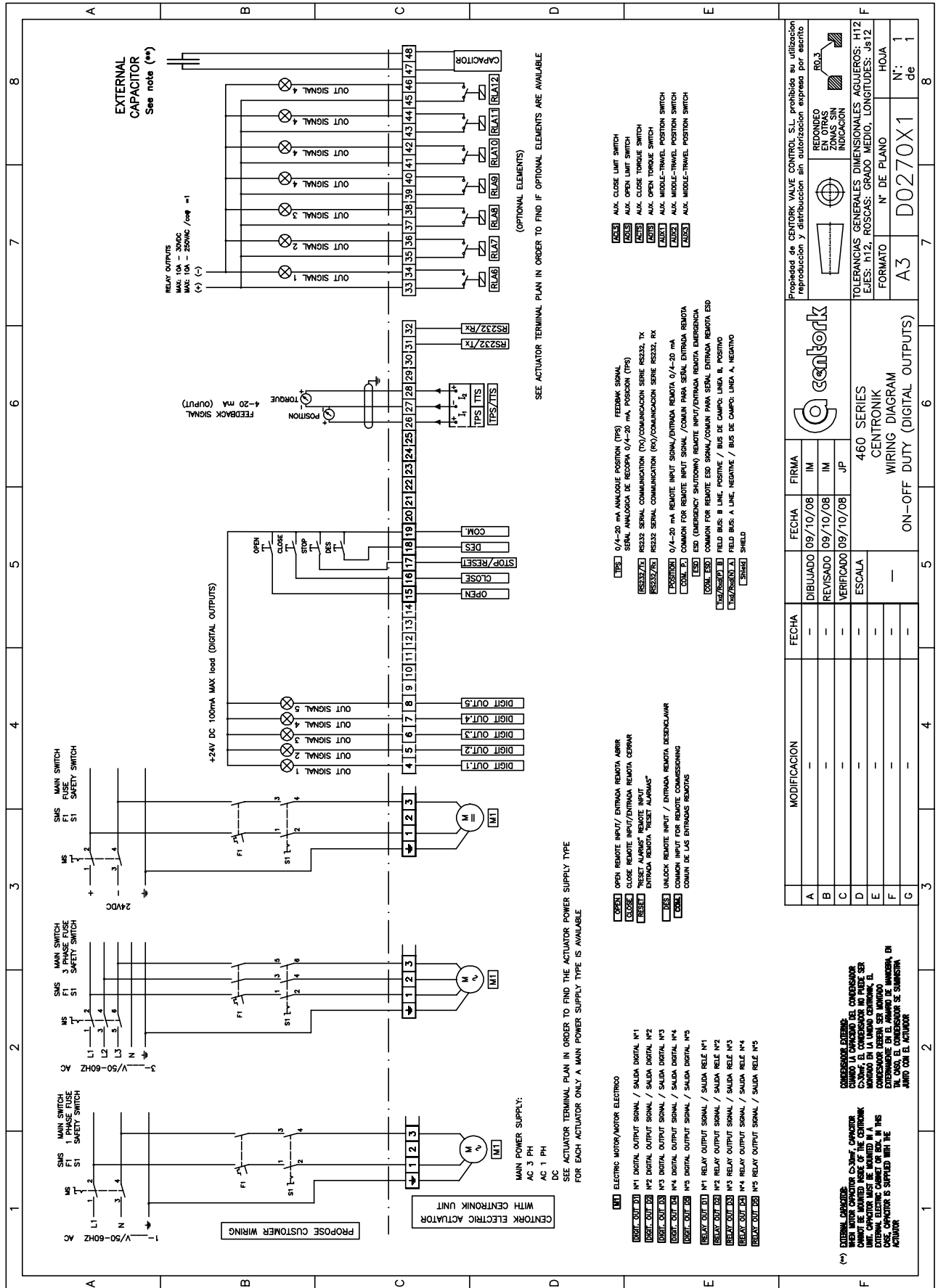

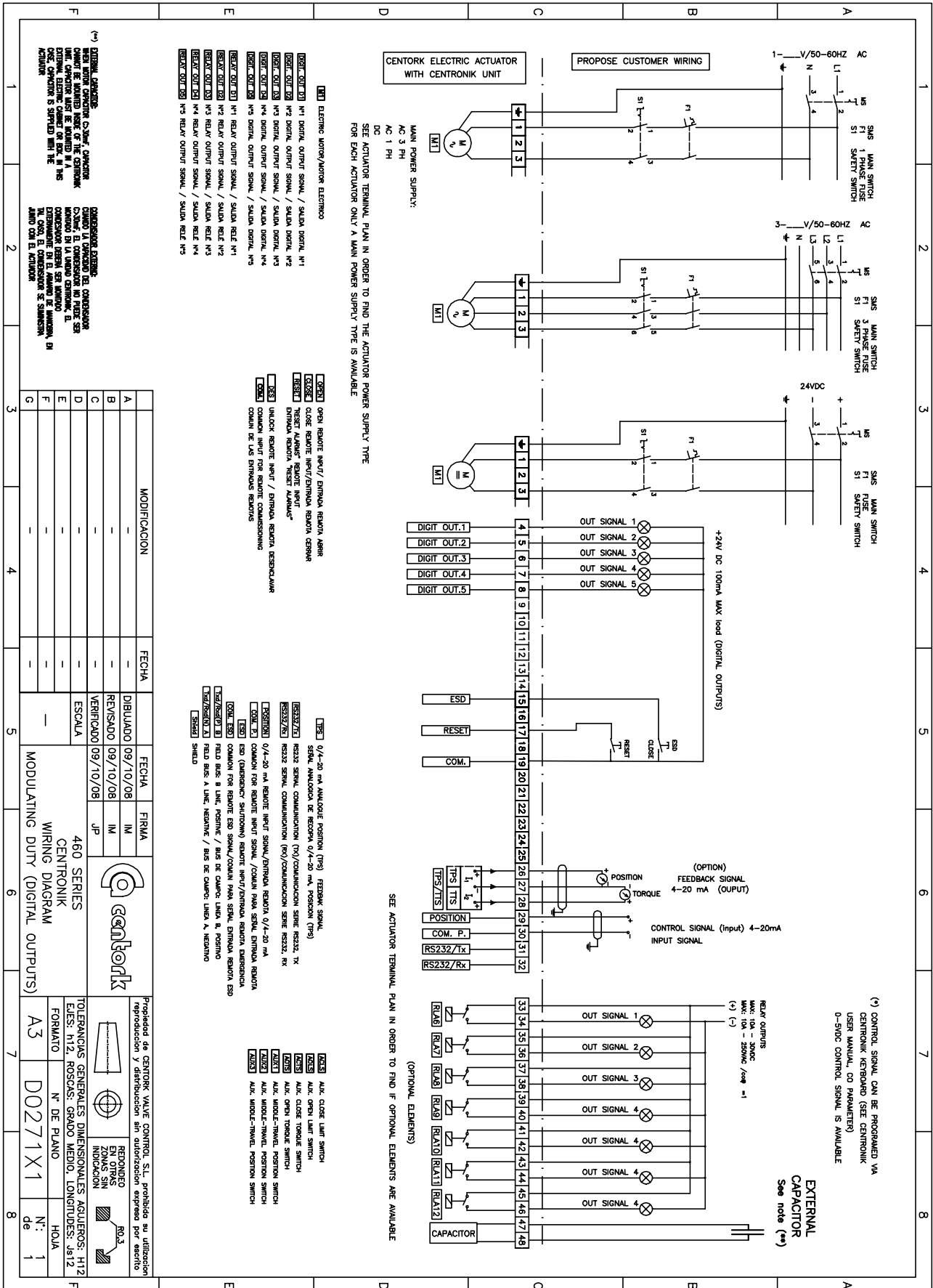

- 0801 ELECTRIC MOTOR/ACTUATOR ELECTROICO
- 0802 0/1-20 mA ANALOGUE POSITION (TPS) FEEDBACK SIGNAL
- 0803 0/1-20 mA ANALOGUE POSITION (TPS) POSITION SIGNAL
- 0804 0/1-20 mA ANALOGUE POSITION (TPS) POSITION SIGNAL
- 0805 0/1-20 mA ANALOGUE POSITION (TPS) POSITION SIGNAL
- 0806 0/1-20 mA ANALOGUE POSITION (TPS) POSITION SIGNAL
- 0807 0/1-20 mA ANALOGUE POSITION (TPS) POSITION SIGNAL
- 0808 0/1-20 mA ANALOGUE POSITION (TPS) POSITION SIGNAL
- 0809 0/1-20 mA ANALOGUE POSITION (TPS) POSITION SIGNAL
- 0810 0/1-20 mA ANALOGUE POSITION (TPS) POSITION SIGNAL
- 0811 0/1-20 mA ANALOGUE POSITION (TPS) POSITION SIGNAL
- 0812 0/1-20 mA ANALOGUE POSITION (TPS) POSITION SIGNAL
- 0813 0/1-20 mA ANALOGUE POSITION (TPS) POSITION SIGNAL
- 0814 0/1-20 mA ANALOGUE POSITION (TPS) POSITION SIGNAL
- 0815 0/1-20 mA ANALOGUE POSITION (TPS) POSITION SIGNAL
- 0816 0/1-20 mA ANALOGUE POSITION (TPS) POSITION SIGNAL
- 0817 0/1-20 mA ANALOGUE POSITION (TPS) POSITION SIGNAL
- 0818 0/1-20 mA ANALOGUE POSITION (TPS) POSITION SIGNAL
- 0819 0/1-20 mA ANALOGUE POSITION (TPS) POSITION SIGNAL
- 0820 0/1-20 mA ANALOGUE POSITION (TPS) POSITION SIGNAL
- 0821 0/1-20 mA ANALOGUE POSITION (TPS) POSITION SIGNAL
- 0822 0/1-20 mA ANALOGUE POSITION (TPS) POSITION SIGNAL
- 0823 0/1-20 mA ANALOGUE POSITION (TPS) POSITION SIGNAL
- 0824 0/1-20 mA ANALOGUE POSITION (TPS) POSITION SIGNAL
- 0825 0/1-20 mA ANALOGUE POSITION (TPS) POSITION SIGNAL
- 0826 0/1-20 mA ANALOGUE POSITION (TPS) POSITION SIGNAL
- 0827 0/1-20 mA ANALOGUE POSITION (TPS) POSITION SIGNAL
- 0828 0/1-20 mA ANALOGUE POSITION (TPS) POSITION SIGNAL
- 0829 0/1-20 mA ANALOGUE POSITION (TPS) POSITION SIGNAL
- 0830 0/1-20 mA ANALOGUE POSITION (TPS) POSITION SIGNAL
- 0831 0/1-20 mA ANALOGUE POSITION (TPS) POSITION SIGNAL
- 0832 0/1-20 mA ANALOGUE POSITION (TPS) POSITION SIGNAL
- 0833 0/1-20 mA ANALOGUE POSITION (TPS) POSITION SIGNAL
- 0834 0/1-20 mA ANALOGUE POSITION (TPS) POSITION SIGNAL
- 0835 0/1-20 mA ANALOGUE POSITION (TPS) POSITION SIGNAL
- 0836 0/1-20 mA ANALOGUE POSITION (TPS) POSITION SIGNAL
- 0837 0/1-20 mA ANALOGUE POSITION (TPS) POSITION SIGNAL
- 0838 0/1-20 mA ANALOGUE POSITION (TPS) POSITION SIGNAL
- 0839 0/1-20 mA ANALOGUE POSITION (TPS) POSITION SIGNAL
- 0840 0/1-20 mA ANALOGUE POSITION (TPS) POSITION SIGNAL
- 0841 0/1-20 mA ANALOGUE POSITION (TPS) POSITION SIGNAL
- 0842 0/1-20 mA ANALOGUE POSITION (TPS) POSITION SIGNAL
- 0843 0/1-20 mA ANALOGUE POSITION (TPS) POSITION SIGNAL
- 0844 0/1-20 mA ANALOGUE POSITION (TPS) POSITION SIGNAL
- 0845 0/1-20 mA ANALOGUE POSITION (TPS) POSITION SIGNAL
- 0846 0/1-20 mA ANALOGUE POSITION (TPS) POSITION SIGNAL
- 0847 0/1-20 mA ANALOGUE POSITION (TPS) POSITION SIGNAL
- 0848 0/1-20 mA ANALOGUE POSITION (TPS) POSITION SIGNAL
- 0849 0/1-20 mA ANALOGUE POSITION (TPS) POSITION SIGNAL
- 0850 0/1-20 mA ANALOGUE POSITION (TPS) POSITION SIGNAL

MODIFICACION	FECHA	DIBUJADO	REVISADO	VERIFICADO	ESCALA	FECHA	FIRMA
A	-	09/10/08	IM	IM	460 SERIES CENTRONIK WIRING DIAGRAM		
B	-	09/10/08	IM	IM	460 SERIES CENTRONIK WIRING DIAGRAM		
C	-	09/10/08	IM	IM	460 SERIES CENTRONIK WIRING DIAGRAM		
D	-	09/10/08	IM	IM	460 SERIES CENTRONIK WIRING DIAGRAM		
E	-	09/10/08	IM	IM	460 SERIES CENTRONIK WIRING DIAGRAM		
F	-	09/10/08	IM	IM	460 SERIES CENTRONIK WIRING DIAGRAM		
G	-	09/10/08	IM	IM	460 SERIES CENTRONIK WIRING DIAGRAM		

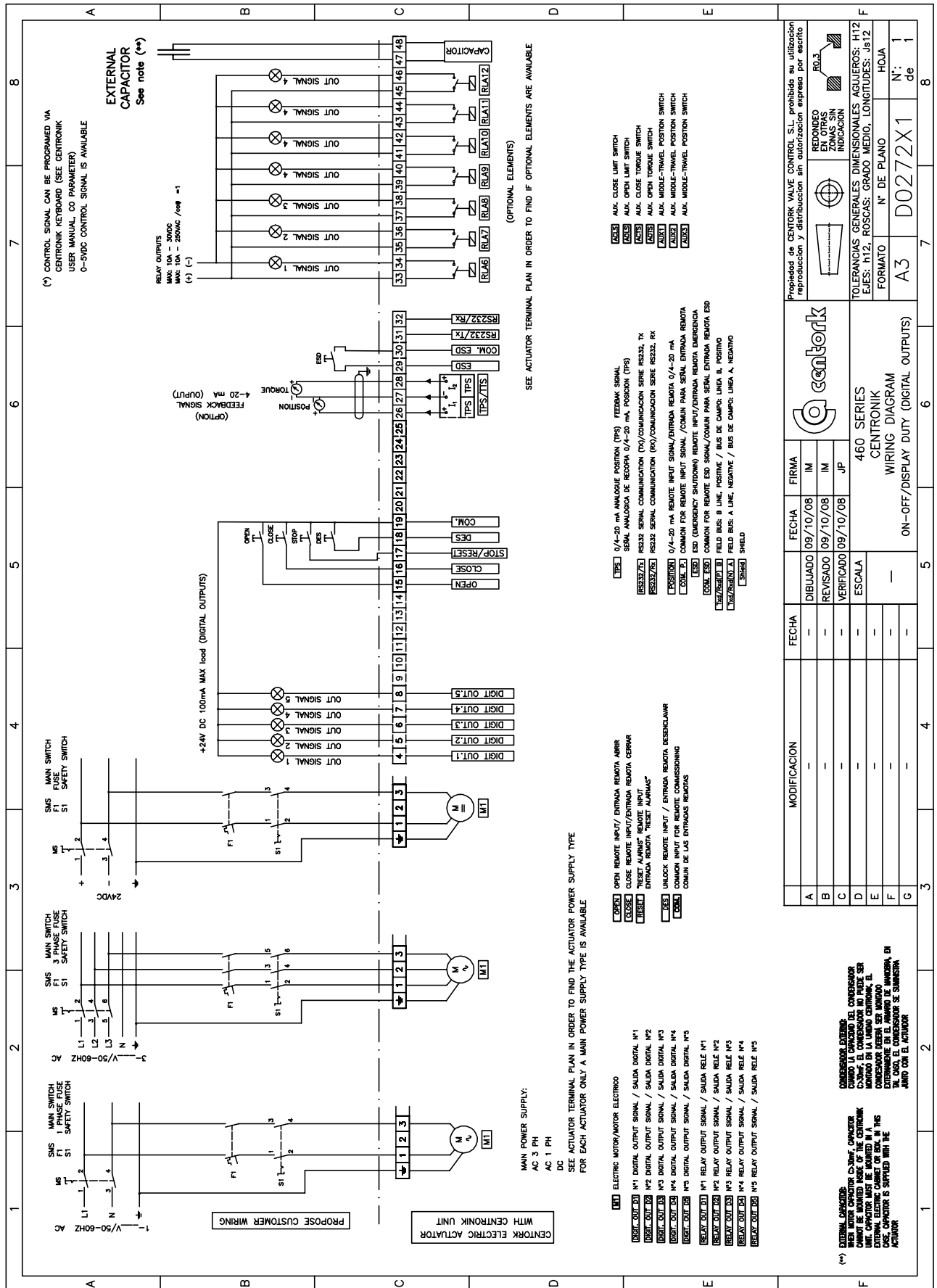

(**) **EXTERNAL CAPACITOR:** WHEN MOTOR CAPACITOR CO-IMP, CAPACITOR CANNOT BE INSTALLED INSIDE OF THE CENTRONIK KEYBOARD. THE CAPACITOR MUST BE INSTALLED EXTERNALLY. ELECTRIC CABLE OR RELAY IN THIS CASE, CAPACITOR IS SUPPLIED WITH THE ACTUATOR.

CONDENSADOR EXTERNO: CUANDO LA OPCIÓN DEL CONDENSADOR CO-IMP, EL CONDENSADOR NO PUEDE SER INSTALADO DENTRO DEL CENTRONIK. EL CONDENSADOR DEBE INSTALARSE EXTERNAMENTE EN EL CABLE DE ALAMBRE, EN TAL CASO, EL CONDENSADOR SE SUMINISTRA JUNTO CON EL ACTUADOR.

MODIFICACION	FECHA	FECHA	FIRMA
A	-	09/10/08	IM
B	-	09/10/08	IM
C	-	09/10/08	JP
D	-	-	ESCALA
E	-	-	-
F	-	-	-
G	-	-	-

centork

460 SERIES CENTRONIK WIRING DIAGRAM (DIGITAL OUTPUTS)

ON-OFF/DISPLAY DUTY (DIGITAL OUTPUTS)

Formato: A3
Nº de Plano: D0272X1
Hojas: 1 de 1

Propiedad de CENTORK-VALVE CONTROL S.L. prohibida su utilización reproducción y distribución sin autorización expreso por escrito

REDONDEO EN SU INDICACION

TOLERANCIAS GENERALES: DIMENSIONALES: AGUJEROS: H12
EJES: h12, ROSCAS: GRADO MEDIO, LONGITUDES: js12

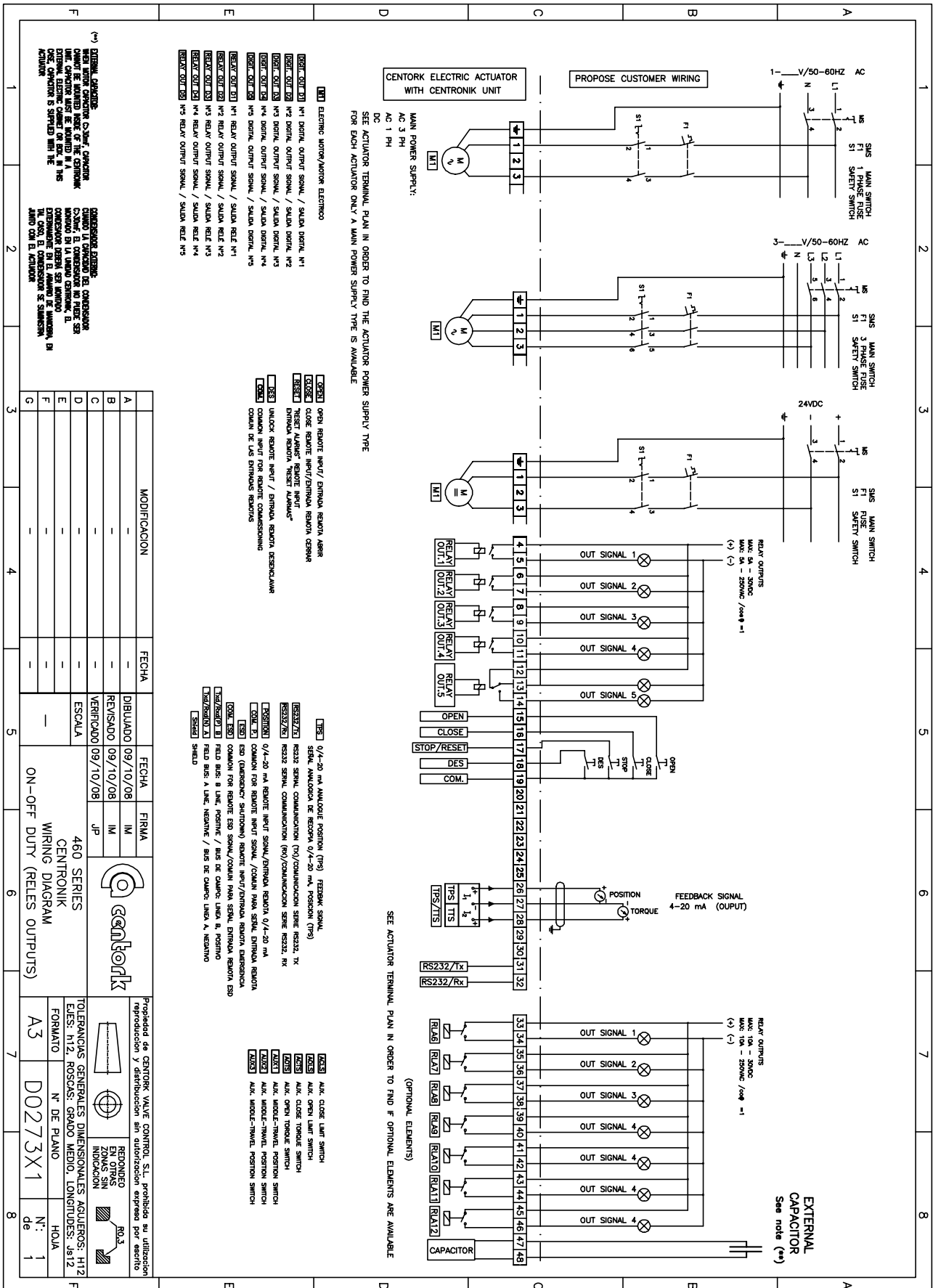

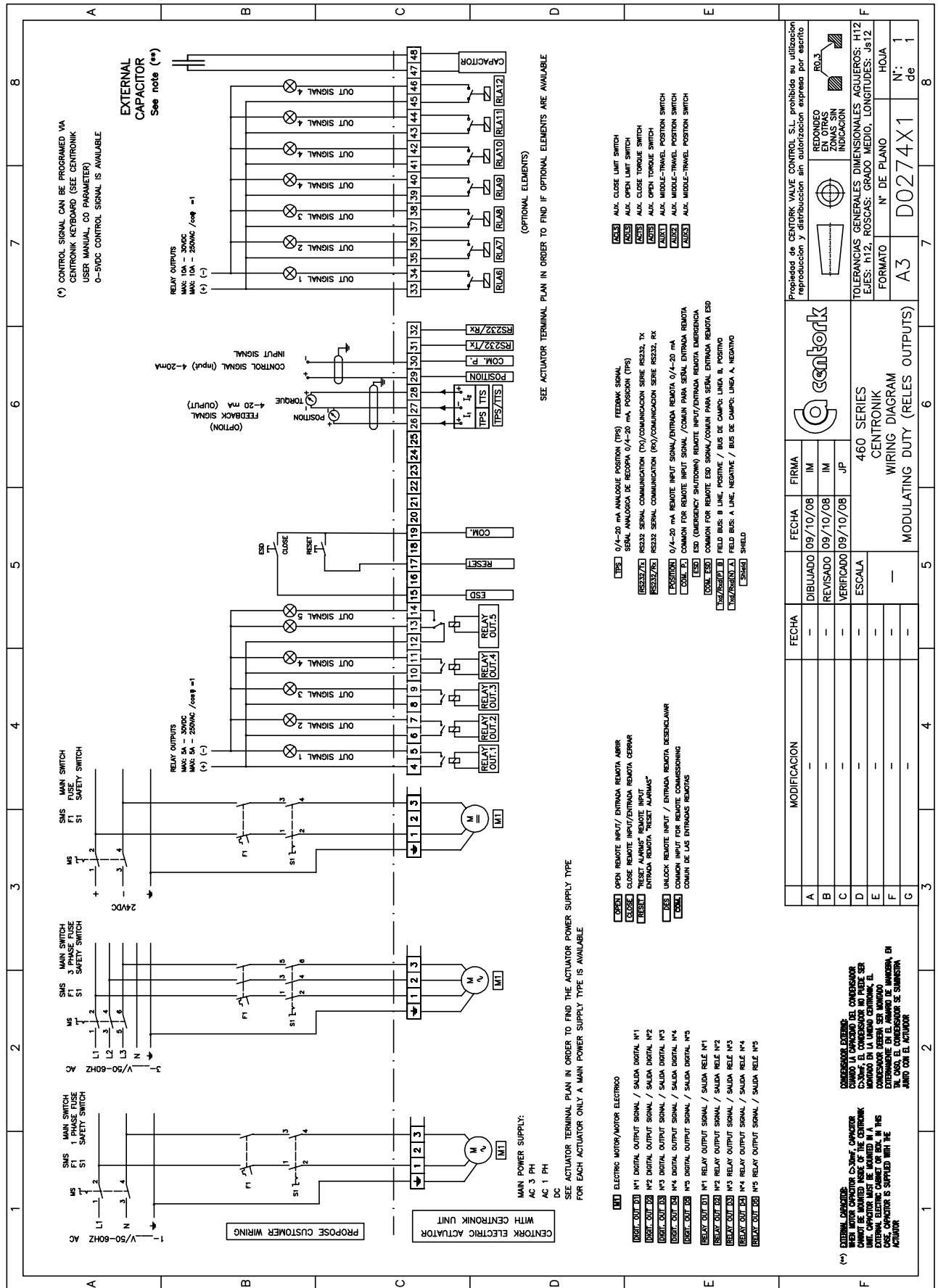

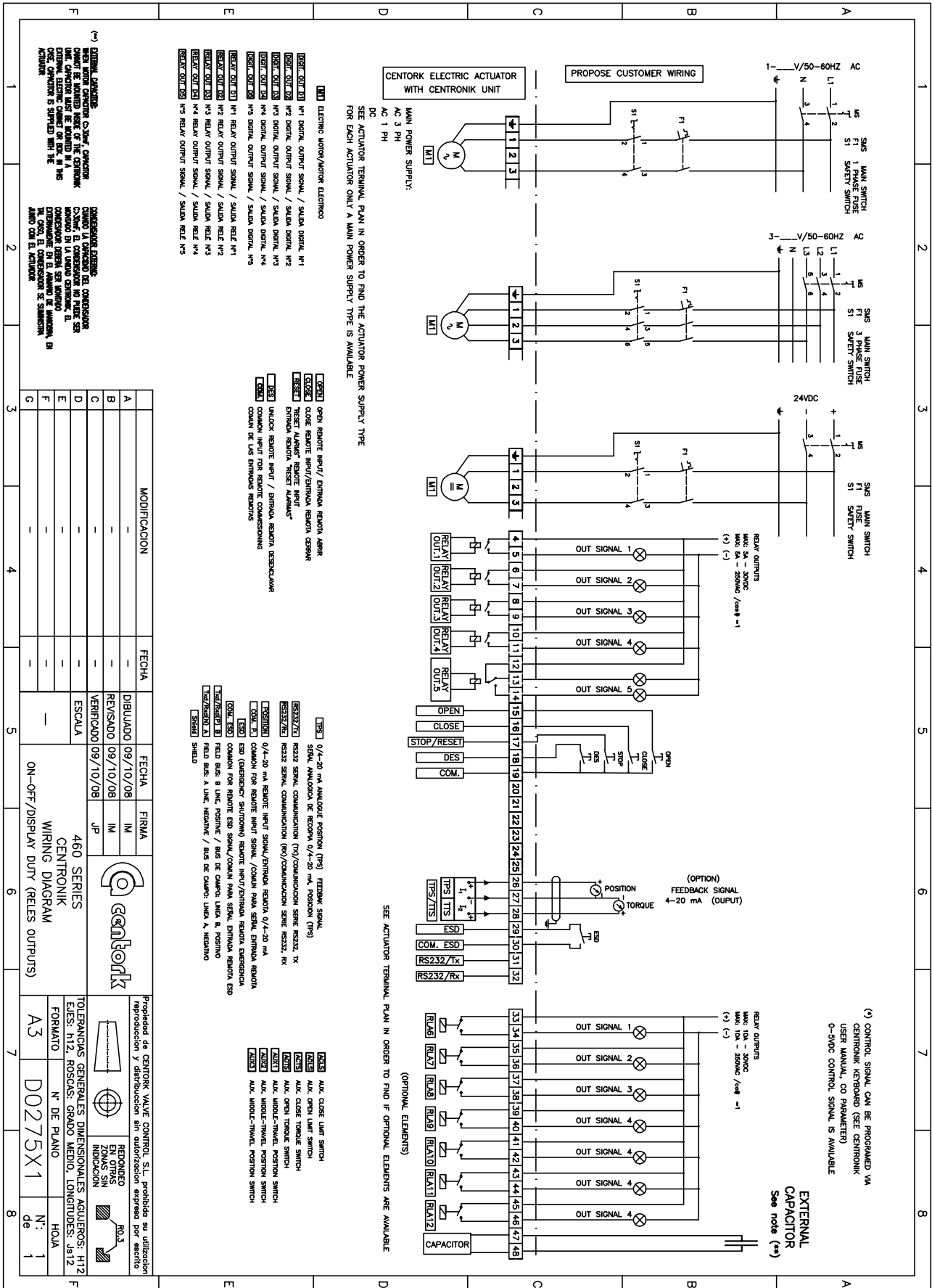

- DC**
SEE ACTUATOR TERMINAL PLAN IN ORDER TO FIND THE ACTUATOR POWER SUPPLY TYPE FOR EACH ACTUATOR ONLY A MAIN POWER SUPPLY TYPE IS AVAILABLE
- [M1] ELECTRIC MOTOR/ACTUATOR ELECTROMOTOR**
- [D01-D03] N1 DIGITAL OUTPUT SIGNAL / SALIDA DIGITAL, N1**
[D04-D06] N2 DIGITAL OUTPUT SIGNAL / SALIDA DIGITAL, N2
[D07-D09] N3 DIGITAL OUTPUT SIGNAL / SALIDA DIGITAL, N3
[D10-D12] N4 DIGITAL OUTPUT SIGNAL / SALIDA DIGITAL, N4
[D13-D15] N5 DIGITAL OUTPUT SIGNAL / SALIDA DIGITAL, N5
[D16-D18] N1 RELAY OUTPUT SIGNAL / SALIDA RELÉ, N1
[D19-D21] N2 RELAY OUTPUT SIGNAL / SALIDA RELÉ, N2
[D22-D24] N3 RELAY OUTPUT SIGNAL / SALIDA RELÉ, N3
[D25-D27] N4 RELAY OUTPUT SIGNAL / SALIDA RELÉ, N4
[D28-D30] N5 RELAY OUTPUT SIGNAL / SALIDA RELÉ, N5

- [O01] OPEN RELAYOTE INPU/ ENTRADA RELAYOTA ABRIR**
[C02] CLOSE RELAYOTE INPU/ ENTRADA RELAYOTA CERRAR
[R03] RESET RELAYOTE INPU/ ENTRADA RELAYOTA RESETEAR
[S04] STOP/RESET RELAYOTE INPU/ ENTRADA RELAYOTA PARAR/RESETEAR
[U05] UNLOCK RELAYOTE INPU/ ENTRADA RELAYOTA DESBLOQUEAR
[C06] COMMON INPU/ ENTRADA RELAYOTA COMÚN DE LAS ENTRADAS RELAYOTA

- [T01] 0/1-20 mA ANALOGUE POSITION (TP) RELAYOTA SEÑAL**
[T02] SEÑAL ANALÓGICA DE POSICIÓN 0/1-20 mA, POSICIÓN (TP)
- [C01] RS232/Tx**
[C02] RS232/Rx
[C03] RS485/Tx
[C04] RS485/Rx
- [E01] 0/1-20 mA RELAYOTE INPU/ ENTRADA RELAYOTA 0/1-20 mA**
[E02] COMMON FOR RELAYOTE INPU/ ENTRADA RELAYOTA COMÚN PARA RELAYOTE INPU/ ENTRADA RELAYOTA
[E03] ESD (EMERGENCY STOP) RELAYOTE INPU/ ENTRADA RELAYOTA ESD
[E04] COMMON FOR RELAYOTE ESD RELAYOTE INPU/ ENTRADA RELAYOTA COMÚN PARA RELAYOTE ESD
[E05] FIELD BUS A LINE, POSITIVE / BUS DE CAMPO, LÍNEA A, POSITIVO
[E06] FIELD BUS B LINE, NEGATIVE / BUS DE CAMPO, LÍNEA B, NEGATIVO
[E07] SHIELD

- [L01] MAX. CLOSE LIMIT SWITCH**
[L02] MAX. OPEN LIMIT SWITCH
[L03] MAX. CLOSE TORQUE SWITCH
[L04] MAX. OPEN TORQUE SWITCH
[L05] MAX. HOUSING-TWIST POSITION SWITCH
[L06] MAX. HOUSING-TWIST POSITION SWITCH
[L07] MAX. HOUSING-TWIST POSITION SWITCH

MODIFICACION		FECHA	FIRMA
A	-	09/10/08	IM
B	-	09/10/08	IM
C	-	09/10/08	JP
D	-	ESCALA	
E	-		
F	-		
G	-		

460 SERIES
CENTRONIK
WIRING DIAGRAM
ON-OFF/DISPLAY DUTY (RELE'S OUTPUTS)

Propiedad de CENTORK VALVE CONTROL, S.L. prohibida su utilización
reproducción y distribución sin autorización expresa por escrito

RECORDED IN OPEN INDICATION

TOLERANCIAS GENERALES DIMENSIONALES AGUIJEROS: H12
EJES: h12. ROSCAS: GRADO MEDIO. LONGITUDES: JS12

FORMATO N° DE PLANO N°: 1
HOLA N°: 1
A3 D0275X1 de 1



CENTORK Valve Control S.L.

Pol. Ind. 110 , Txatxamendi 24-26
Telf.: +34.943.31.61.36
Email: actuator@centork.com

LEZO 20.100 (SPAIN)
Fax:: +34.943.22.36.57
<http://www.centork.com>

1497MANE1462X001

Edition: 01.10