

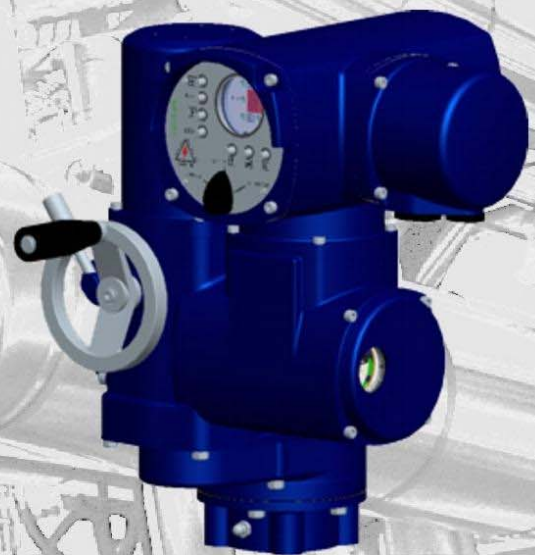

Centork electric actuators 40C to 40F and 41C to 41F series PROFIBUS DP



Hazardous areas

*Installation and maintenance
User manual*

THIS USER MANUAL HAS BEEN DEVELOPED FOR centork ELECTRIC ACTUATOR 40C, 41D, 40E AND 41F SERIES WITH CENTRONIK UNIT WITH PROFIBUS DP (FIELD BUS), FOR USE IN POTENTIALLY EXPLOSIVE ATMOSPHERES, ATEX VERSION.



CAUTION

centork Electric actuators are high value devices. In order to prevent damage in their handling, setting and use it is essential to follow and observe all the points in this user manual, operate under actuators' designated use, and observe health and safety rules, standards and directives, as other national regulations as well.

centork Electric actuators must be handled with care and caution.

IMPORTANT NOTE

This work and the information it contains are property of CENTORK Valve Control S.L. The information it contains will not be reproduced or disclosed, in whole or in part, without the prior written consent of CENTORK.

The contents in this manual are subject to change due to the quality improvement without individual notice.

Index

1	CENTORK ELECTRIC ACTUATORS: INTRODUCTION	7
2	SAFETY INSTRUCTIONS.....	7
3	TRANSPORT AND STORAGE	8
3.1	Transport.....	8
3.2	Storage and commissioning.....	8
3.2.1	Commissioning	8
3.2.2	Storage	9
4	CONDITIONS OF SERVICE FOR ELECTRIC ACTUATORS	10
4.1	Electric actuator: Main description and purpose.....	10
4.2	Operation modes: OFF, LOCAL and REMOTE mode.....	10
4.2.1	OFF mode.....	10
4.2.2	LOCAL mode.....	10
4.2.3	REMOTE mode.....	11
4.2.4	Program mode.....	11
4.3	Technical data: Explosion protection	12
4.4	Actuator and motor duty service	12
4.5	Temperature range	12
4.6	IP protection degree.....	12
4.7	Painting and protection against corrosion.....	12
4.8	Centronik types: Identification.....	13
4.9	Actuator identification.....	13
5	INTRODUCTION TO PROFIBUS DP.....	14
5.1	General description.....	14
5.2	Network overview.....	14
5.3	Primary functions	14
5.4	Transfer mode and bus access.....	14
5.5	Technical features for PROFIBUS-DP.....	15
6	CENTORK PROFIBUS-DP INTERFACE OVERVIEW.....	16
6.1	Mechanical overview.....	16
6.2	Protocol & Supported Functions	16
6.3	Physical Interface.....	16
6.4	Configuration & Indications	16
6.5	Data Exchange.....	16
7	MOUNTING TO THE VALVE	17
7.1	Pre-Installation Inspection.....	17
7.2	Output size	17
7.3	Output type.....	17
7.4	Mounting.....	17
7.5	Frontal panel orientation	18
8	ELECTRICAL CONNECTIONS	19
8.1	Wiring diagram (electric manoeuvre).....	19
8.1.1	Duty service	19
8.1.1.1	ON/OFF duty.....	19
8.1.1.2	Modulating duty.....	19
8.1.1.3	ON/OFF duty with position.....	19
8.1.2	Components.....	20
8.1.2.1	Voltage supply.....	20
8.1.2.2	Digital outputs	20
8.1.2.3	Relay outputs	20
8.1.2.4	Position transmitter	21
8.1.2.5	Capacitors	21
8.1.2.6	Fiedl bus.....	21

8.1.2.7	Other elements	21
8.2	Terminal plan and wiring	22
8.3	Cable installation in accordance with EMC	23
9	MANUAL OPERATION	23
10	LOCAL MODE: CONTROL AND DISPLAYS ELEMENTS	24
10.1	Lockable selector	24
10.2	Push-buttons	25
10.3	LED indications	25
11	SWITCHING AND SIGNALING UNIT	26
12	SETTINGS AND PRELIMINARY TESTS (START-UP)	27
12.1	DIP-SWITCHES configuration	28
12.1.1	Operation mode	28
12.1.2	Centronik output signals configuration (Only in ON/OFF duty)	28
12.1.3	Actuator and valve (Sense of rotation)	29
12.1.4	Posicion transmitter range (only in Modulating duty and ON/OFF duty with position display) 29	
12.1.5	Remote mode selection	29
12.2	Closed position limit switch setting	30
12.3	Open position limit switch setting	31
12.4	Torque switching setting	31
12.5	Mechanical position indicator setting (optional)	32
12.6	Auxiliary limit switches setting (optional)	32
12.7	Potentiometer POT setting (optional)	33
12.8	0/4-20mA transmitter TPS setting (optional)	33
12.9	CENTRONIK setting procedure (only Modulating and On-Off with display units)	34
12.9.1	Access to program mode – Password	35
12.9.2	Control input signal (only in Modulating duty)	35
12.9.3	Polarity (only in Modulating duty)	36
12.9.4	Zero and span for Control input and TPS –feedback signal- (only in Modulating duty)	36
12.9.5	Outputs signals (Digital or relays outputs)	38
12.9.6	Rest time	38
12.9.7	Valve opening curves (only in Modulating duty)	39
12.9.8	Operation mode ESD (only in Modulating duty and ON/OFF duty with position display)	40
12.9.9	Operation mode “Bus Fail” BF (only in Profibus DP)	40
12.9.10	Deadband (only in Modulating duty)	41
12.9.11	Autolearn (only in Modulating duty)	42
12.9.12	Close tightly (only in Modulating duty)	42
12.9.13	Blinker (only in Modulating duty and ON/OFF duty with position display)	42
12.9.14	Calibration of the CENTRONIK unit (only in Modulating duty and ON/OFF duty with position display) 43	
12.9.15	Inching mode (only in ON/OFF duty with position display)	43
12.9.16	Stepping mode (only in ON/OFF duty with position display)	43
12.9.17	Data logging	45
12.9.18	New Password	45
12.9.19	Actuator parameters for Fieldbus (PROFIBUS-DP)	46
13	FIELDBUS (PROFIBUS-DP) CONFIGURATION	47
13.1	Fieldbus Connector	47
13.1.1	Centork connector	47
13.2	Configuration	47
13.2.1	CENTRONIK unit configuration	47
13.2.2	Baudrate and Parity	47
13.2.3	Actuator node address (Slave) configuration	47
13.2.4	Termination	48
13.2.5	Led Indications of actuator PROFIBUS-DP interface	48
14	FIELDBUS PROGRAMMING	50
14.1	MODULATING CENTRONIK units	50
14.1.1	Master instructions:	50
14.1.2	Actuator (Slave) response:	50

14.1.3	Status	52
14.1.3.1	DIPSWITCHES	52
14.1.3.2	P1	52
14.1.3.3	P2	52
14.1.3.4	Remote inputs	52
14.1.3.5	Remote outputs	52
14.1.3.6	Phase	52
14.1.3.7	Overtravel OP	52
14.1.3.8	Overtravel CL	52
14.1.3.9	Nominal input (%)	52
14.1.4	Parameter GROUP1	53
14.1.4.1	Nominal input type	53
14.1.4.2	Nominal input –Current-	53
14.1.4.3	Polarity	53
14.1.4.4	Nominal input zero –split range- (%)	53
14.1.4.5	Opening zero (%)	53
14.1.4.6	Nominal input span (%)	53
14.1.4.7	Opening span (%)	54
14.1.4.8	Rest time	54
14.1.4.9	Autolearn	54
14.1.4.10	Output signals 1, 2, 3, 4 and 5	54
14.1.4.11	Inner Dead Band OP (Opening)	55
14.1.4.12	Outer Dead Band OP(Opening)	55
14.1.4.13	Inner Dead Band CL (Closing)	55
14.1.4.14	Outer Dead Band CL (Closing)	55
14.1.4.15	Blinker	55
14.1.5	Parameter GROUP2	56
14.1.5.1	Close tightly	56
14.1.5.2	Tightly Value (%)	56
14.1.5.3	Bus Fail: BF action and BF (%)	56
14.1.5.4	Bus Fail: BF time	56
14.1.5.5	Valve Opening Curve type	56
14.1.5.6	ESD override	57
14.1.5.7	ESD action and ESD (%)	57
14.1.6	Data logging	57
14.1.6.1	Number of opening operations	57
14.1.6.2	Number of closing operations	57
14.1.6.3	Number of open torque faults	57
14.1.6.4	Number of close torque faults	58
14.1.6.5	Total running hours	58
14.1.6.6	Number of thermal faults	58
14.1.6.7	Number of powering	58
14.1.7	Map of communication: SUMMARY for MODULATING duty	59
14.2	ON /OFF with display CENTRONIK units	60
14.2.1	MASTER instructions	60
14.2.2	Actuator (Slave) response:	60
14.2.3	Status	61
14.2.3.1	DIPSWITCHES	61
14.2.3.2	P1	61
14.2.3.3	P2	61
14.2.3.4	Remote inputs	62
14.2.3.5	Remote outputs	62
14.2.3.6	Phase	62
14.2.4	Data logging	62
14.2.4.1	Number of opening operations	62
14.2.4.2	Number of closing operations	62
14.2.4.3	Number of open torque faults	62
14.2.4.4	Number of close torque faults	63
14.2.4.5	Total running hours	63
14.2.4.6	Number of thermal faults	63
14.2.4.7	Number of powering	63
14.2.5	Map of communication: SUMMARY for ON-OFF with DISPLAY duty	64

14.3	ON/OFF CENTRONIK units	65
14.3.1	MASTER instructions.....	65
14.3.2	Actuator (Slave) response:	65
14.3.3	Status.....	66
14.3.3.1	<i>DIPSWITCHES</i>	66
14.3.3.2	<i>P1</i>	66
14.3.3.3	<i>P2</i>	66
14.3.3.4	<i>Remote inputs</i>	66
14.3.3.5	<i>Remote outputs</i>	66
14.3.3.6	<i>Phase</i>	67
14.3.4	Map of communication: SUMMARY	68
15	TROUBLE SHOOTING	69
15.1	Front panel indication fault	69
15.2	Actuator does not operate in LOCAL mode	70
15.3	Actuator does not operate correctly in REMOTE mode	70
15.4	Actuator turn in the wrong sense.....	70
15.5	Digital outputs does not work	70
16	MAINTENANCE	71
16.1	Commissioning, after the star-up	71
16.2	Maintenance for service	71
16.3	Electric actuator's service life	71
16.4	Fuse replacement.....	72
17	TECHNICAL SUPPORT	73
18	LIST OF SPARE PARTS	74
18.1	Actuator unit	74
18.2	Centronik unit	75
	APPENDIX: OUTPUT TYPES	76

1 CENTORK ELECTRIC ACTUATORS: INTRODUCTION

The electric actuator is a device designed to be coupled to a general-purpose industrial valve, to carry out its movement. The movement is stopped by limit switching or by torque (thrust) switching.

Other applications should be consulted CENTORK before. CENTORK is not liable for any possible damages resulting from use in other than designated applications. Such risk lies entirely on the user.

2 SAFETY INSTRUCTIONS

The scope of this manual is to enable a competent user to install, operate, adjust and inspect a CENTORK electric actuator. These instructions must be observed, otherwise a safe operation of the actuator in no longer warrantee.

When handling electric equipment, the health and safety standards (EN 60.204, 73/23/EEC directives) and any other national legislation applicable must be observed.

For works carried out in hazardous areas special regulations and directives must be observed; 89/655/EEC directive and EN 60079 standard. Areas classification, where devices and work take place under potentially explosives atmospheres, is a user responsibility, according to 1999/92/CE directive.



Work at the open actuator under voltage must only be performed if it is assured that for the duration of the work there is no danger of explosion. In other conditions actuator should be carry to a safe area.



As electric device, during electrical operation certain parts inevitably carry lethal voltages and currents (ELECTRICAL RISKS).

Works on the electrical system or equipment must only be carried out by a skilled electrician himself or by specially instructed personnel, in accordance with the applicable electrical engineering rules, health and safety Directives and any other national legislation applicable.

Electric actuators are powerful apparatus. A negligence handling might cause severe damages to valves, people, and actuator as well. Under no circumstances should any modification or alteration be carried out on the actuator as this could very well invalidate the conditions which the device was designed.



Under operation, motor enclosure surfaces can reach high temperatures (up to 100°C). Protection measures should be taken into account in order to prevent people and goods from it.

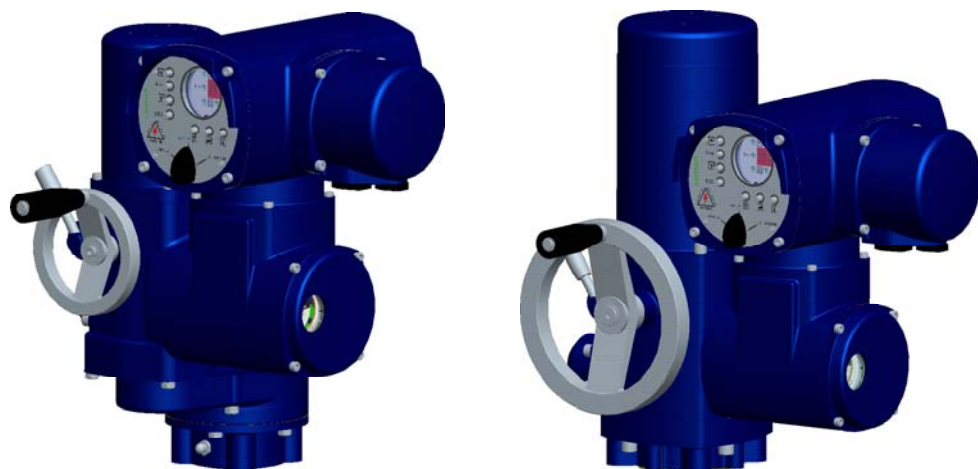

3 TRANSPORT AND STORAGE

3.1 Transport



- **CENTORK electric actuators must be transported in sturdy packing.** During transport measures should be adopted in order to prevent impacts, hits. CENTORK delivers its actuators ex-work.
- **For transport purposes, handwheels are supplied separately.**
- **Hits or impacts against wall, surfaces or objects might cause severe damage on Electric actuator.** In these cases, after such events, a technical inspection must be done by CENTORK technicians.
- **Do not attach to the handwheel ropes or hooks to lift by hoist.**
- The valve-actuator unit cannot be lifted/manipulated employing any lifting point of the actuator; Actuator has been designed and sized in order to motorize industrial valves, and withstand the forces and torque required.
- **Covers have to be properly closed (Tight) and sealed. Cable entries on electrical connection cover must be sealed. Protection plug supplied by CENTORK are only adequate for storing in dry and ventilated places, for short period of time. In other conditions protection plug must be replaced with metallic plug sealed with PTFE tape.**
- Each Actuator is delivered with a set of technical documentation (User manual, datasheet, diagrams...), which has to be carefully stored.

3.2 Storage and commissioning

Despite of their high degree of protection (IP67 as standard, and IP68 optional) condensation – presence of water- can occur inside the electric actuators by incorrect and negligent handling of the actuators. This may damage sensitive internal parts during the storage. This problem can be avoided by observing the following points.

3.2.1 Commissioning

- Verify the actuator to insure correct model number, torque, operating speed, options and special components, voltage and enclosure type, and the actuator control before installation or use. It is important to verify that the actuator is appropriate for the requirements of the valve and the intended application. If there is any discrepancy, please contact with your local distributor, or CENTORK, to solve that discrepancy. Once the electric actuator has been set up, CENTORK decline any responsibility related to discrepancies.
- Check (Visual inspection) in order to detect possible damages caused during transport or storage. **Checking should include a visual inspection of electric compartment, and switching and signalling unit compartment.**
- Check that the painting work of the actuator is not been damaged. Retouch it when damaged.
- Check that electrical connection cover, centronik frontal panel and switching and signalling unit cover and are correctly closed and tight. Cable entries on electrical connection cover must be sealed. Protection plug supplied by CENTORK are only adequate for storing in dry and ventilated places, for short period of time. In other conditions **protection plug must be replaced with metallic plug sealed with PTFE tape.**
- Each Actuator is delivered with a set of technical documentation (User manual, datasheet, diagrams...), which has to be carefully stored.
- If damages like shocks, cracks, hits or others due to an improper handling, or humidity inside the equipment due to improper storage appear, contact CENTORK or your nearest distributor.

3.2.2 Storage



- **Store in a clean, cool, dry and ventilated place. Protect against humidity from the floor. Use pallets, wooden frames, cage boxes or shelves.**

- Check that electrical connection cover and switching and signalling unit cover and are correctly closed and tight.



- Cable entries on electrical connection cover must be sealed. Protection plug supplied by CENTORK are only adequate for storing in dry and ventilated places, for short period of time. In other conditions **protection plug must be replaced with metallic plug sealed with PTFE tape.**



- Do not store the actuator directly on the ground!
- Cover it to protect it from dust and dirt. Cover the machined parts with suitable protection against corrosion. Do not employ plastic bags, as they can cause condensation.
- Each Actuator is delivered with a set of technical documentation (User manual, datasheet, diagrams...), which has to be carefully stored.
- **For other storage conditions or, and long time periods (More than 5 months) contact to manufacturer.**

4 CONDITIONS OF SERVICE FOR ELECTRIC ACTUATORS

4.1 Electric actuator: Main description and purpose

- Electric actuator is an apparatus or device formed by an electric motor, coupled to a main gearbox unit, which transmits motion and torque to valves.
- Power supply and controls elements (transformer, relays, leds, electronic boards...) are included in the Centronik unit. Centronik unit has CPU microprocessor and electronic boards: Electric actuator is operated and controlled by means of these electronic and electric device of the centronik unit, being supplied with main power.
- Electric actuator can be controlled in LOCAL mode by mean of pushbuttons located in the centronik front panel or in REMOTE mode with remote controls such us SCADA, PLC, or a MASTER STATION by mean of a FIELDBUS (Profibus DP)
- Electric actuators are provided with a declutchable manual override system in order to operate manually in case of emergency or fail of power supply.
- Electric actuator can be coupled directly to valve, or maybe, through gearbox units (Bevel, spur and worm gearboxes).
- The electric actuator is a device designed to be coupled to a general-purpose industrial valve, to carry out its movement. The movement is stopped by limit switching or by torque (thrust) switching. Other applications should be consulted CENTORK before. **CENTORK is not liable for any possible damages resulting from use in other than designated applications. Such risk lies entirely on the user.**

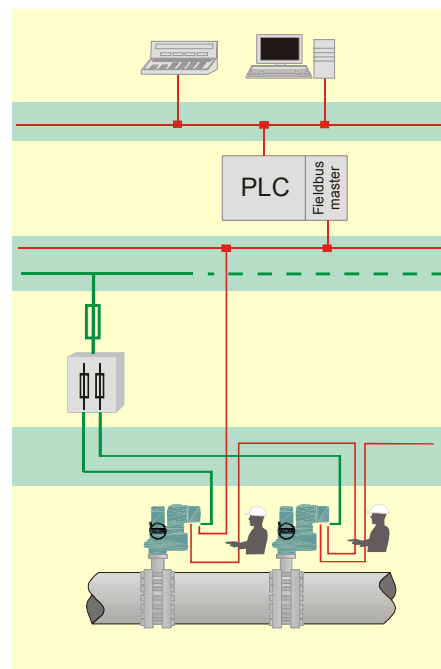

4.2 Operation modes: OFF, LOCAL and REMOTE mode

Electric actuator can be controlled by the control station (REMOTE mode) and at the local control (LOCAL mode). Centronik unit is equipped with local pushbuttons. The lockable selector switch LOCAL/OFF/REMOTE allows the operation mode to be set.

4.2.1 OFF mode.

- In this operation mode, the actuator remains connected and powered but it does not responds to any order (Open, close or stop) from the front panel or from the remote control, but actuator will be online, from a FIELDBUS point of view. The front panel control indicates only the power supply status (led 5).

4.2.2 LOCAL mode.

- By mean of push buttons OPEN-CLOSE-STOP located on the centronik front panel, the actuator can be operated locally. 5 indication lights (LEDs) show the actuator status from the centronik front panel (chapter 10.3).
- Push buttons are **self-retaining** type: Once the push button has been pressed, its order or action is generated, and it remains “active” until a new order or command is generated, or any operation event takes place such us a limit switch or torque switch signal, an anomaly case or any centronik function or event. It is NOT necessary to keep “pressing” the pushbutton.

4.2.3 REMOTE mode.

Electric actuator with ON/OFF duty control:

- Electric actuator can be controlled by the control station (REMOTE) with the commands OPEN-CLOSE-STOP (**self-retaining**) or OPEN-CLOSE (“**push to run**” operation) as option.
- ON/OFF duty control means open loop control.
- With **self-retaining operation**, the actuator continues to run as long as the STOP command from the control system (digital input) is not being generated, or any centronik operation condition takes place.
- With “**push to run**” operation (Inching mode) the actuator continues to run as long as this command from the control system (digital input) remains. It is necessary to keep “pressing” the pushbutton or the remote input.
- TPS Electronic position transmitter (0-4/20mA, 0-2/10V or resistive value) can be employed, as option, which in order to provide the real valve position indication. The value can not be read through the bus communication (See communication map for on-off duty, on 14.3.4 chapter)

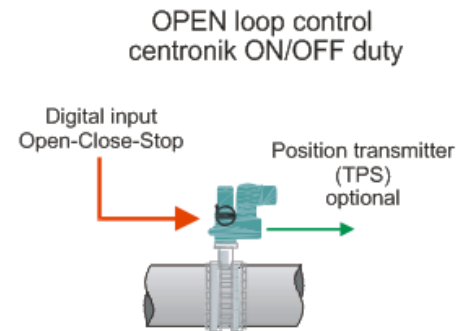

Electric actuator with modulating duty control:

- Electric actuator is equipped with an electronic integral positioner that automatically positions the valve in accordance with the analogue input control signal (0-4/20mA current signal and voltage signal as option, or the input data coming from the MASTER STATION)
- Modulating duty control means close loop control. The centronik modulating duty positioner registers and compares the analogue input control and the actual position value (Feedback signal given by actuator position transmitter). The electric actuator runs to OPEN or CLOSE direction, according to the deviation detected.
- The modulating behaviour is stabilised by determining inner (internal) and outer (external) deadbands, rest time and therefore the wear of valve and actuator can be reduced.

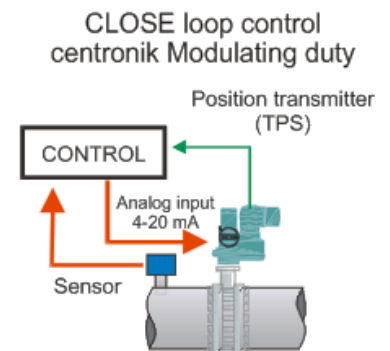

Electric actuator with ON/OFF duty control, with position display:

- This mode is has an ON/OFF duty control but with some advance and upgrade functions:
 - Some parameters can be configured via the centronik frontal panel.
 - Frontal panel has a continuous position display.
 - Analogue (mA) feedback valve position signal.
 - A programmable emergency shut-down ESD function is available (See 12.9.8 chapter)
 - Some different operation modes can be programmed or set.

4.2.4 Program mode

- The **program mode** allows to configure and set the actuator fieldbus (PROFIBUS DP) parameters (See 12.9.19 chapter)
- For **on-off with display** and **modulating** duties centronik units, by mean of the program mode it is possible to select and configure the centronik parameters, functions and features, see 12.9 chapter.
- In order to access to this mode, it is necessary to switch the centronik selector in LOCAL mode and introduce the correct PASSWORD, see 12.9.1 chapter.

4.3 Technical data: Explosion protection

The marking of the electrical actuator is:  II 2G EEx de IIC T4

The electrical actuator is made up of an **explosion-proof electrical motor, reduction gears and electric terminal compartment in increased security, the switching and signalling unit and centronik unit electronic boards and elements are enclosed in an explosion-proof enclosure.**

For works carried out in hazardous areas special regulations and directives must be observed; 89/655/EEC directive and EN 60079 standard. Areas classification, where devices and work take place under potentially explosives atmospheres, is a user responsibility, according to 1999/92/CE directive.

The electrical actuators with single-phase motors, the capacitors will have to be installed in safety zone or to be equipped with a valid way of protection for the zone of use.

In the APPENDIX it appears certificates of the electrical actuators, as well as the declaration of conformity.

4.4 Actuator and motor duty service

Electric actuator has been designed for valve motorization which requires ON-OFF and inching or modulating duty service.

- **ON-OFF duty service**: Electric actuator has been designed as S2-15 min (Three phases motor) or S2-10 min (Single phases motors) duty cycle at nominal torque, according to IEC standards: Nominal torque is rated to 50% of max tripping torque (100%), value marked on actuator nameplates. Higher nominal torques can reduce the actuator's service life and S2 duty cycle.
- **Inching or modulating duty service**: Electric actuators have been designed as S4-25%, at 1.200-800 starts per hour, at nominal torque. Nominal torque is rated to 50% of max tripping torque (100%), value marked on actuator nameplates. Higher nominal torques can reduce the actuator's service life and S4 duty cycle conditions.

4.5 Temperature range

CENTORK Electric actuators work in a temperature range from -20°C to +70°C.

4.6 IP protection degree

- CENTORK Electric actuators are designed in their standard version with IP67 (acc. EN 60.529) environmental protection although IP68 protection may be supplied on request.
- **IP67 and IP68 protection degree is only guarantee employing proper protection plug and cable gland (For cable entries)**, according to IP degree (Chapter 8.2).
- It is necessary to observe storing and maintenance rules written on TRANSPORT AND STORAGE as well (Chapter 3).

4.7 Painting and protection against corrosion

- CENTORK has designed three protections degree: Standard protection, P1 and P2. For technical details, consult CENTORK technical datasheets.
- CENTORK standard protection: Electric actuators are coated with an epoxy- two components primer (Film thickness depends on protection class selected, actuators are coated with intermediates primers) followed by a polyurethane component paint coat. The standard colour is blue RAL 5.003. Other colours are possible (Option). Other film thickness under request.

4.8 Centronik types: Identification

The followings data are defined on the Centronik nameplates.

As standard, there are 3 types of control of centronik unit:

- **On-off** control centronik unit
- **Modulating** control centronik unit
- **ON-Off** with display control centronik unit.

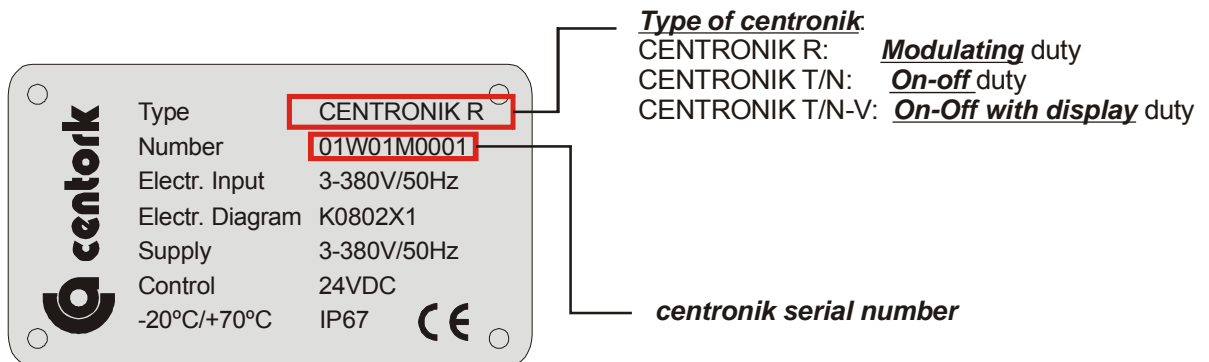

- The type of centronik (Control) is indicated and marked in the centronik nameplates, and it is described also in the CENTORK acknowledgment order. On the nameplate is also depicted other features as: Main power supply and terminal plan (Electric diagram)
- The centronik serial number must be the same as the actuator serial number (printed on actuator and motor nameplates), if the actuator has been supplied as a whole unit.
- **The centronik serial number allows defining and identifying all actuator data. It will be required for any consult concerning to the electric actuator.**



4.9 Actuator identification

The actuator serial number allows defining and identifying all actuator data. It will be required for any consult concerning to the electric actuator.

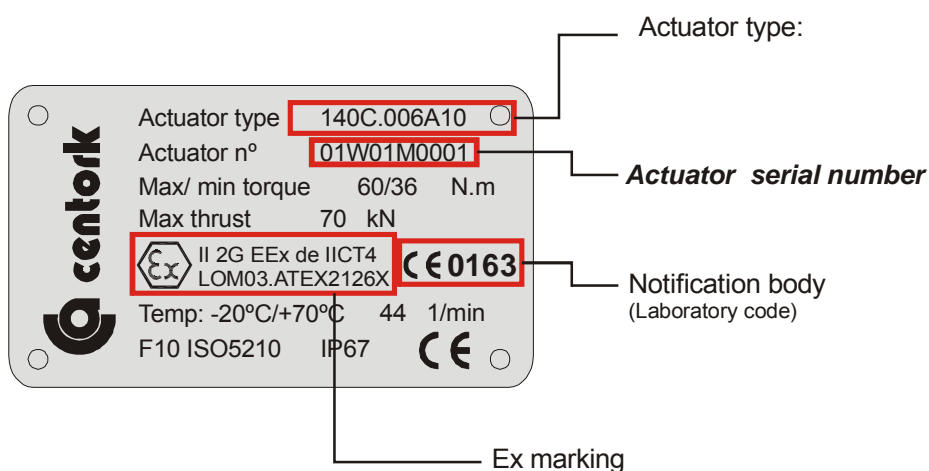

5 INTRODUCTION TO PROFIBUS DP

Nowadays information technology (IT) is increasingly determining growth in the world of automation. The communications capability of devices and continuous, transparent information routes are indispensable components of future-oriented automation concepts. Profibus represents one of the best-known industrial Fieldbus protocols from Europe. Profibus can be used in a very wide range of applications as a multi-application communications link for industrial devices, as well as cell-level communication.

Standardized as EN50170, ensures manufacturers and users investments and guarantees the independence of the manufacturer.

This user manual does not pretend to provide a detailed introduction to PROFIBUS-DP. If more detailed information were needed, please refer to specialized bibliography.

5.1 General description

Profibus utilizes a non-powered two-wire (RS485) network. A Profibus Network may have up to 126 nodes. It can transfer a maximum of 244 bytes data per node per cycle. Communication (baud) rates are selectable but overall end-to-end network distance varies with speed. Maximum Communication (baud) rate is 12Mbps with a maximum distance of 100M (328ft). The maximum distance is 1200M (3936 ft) at 93.75Kbps without repeaters. Profibus connects to a wide variety of field devices including discrete and analog I/O, drives, robots, HMI/MMI products, pneumatic valves, actuators, transducers, and flow measuring equipment.

The data flows by the field cyclically. The Master devices of the fieldbus, are the ones to control the data flow cycles in the fieldbus. They are capable of sending messages without an external request. The Slave devices are those that only can listen to the messages sent by a master and answer that message if it was sent to its address. CENTRONIK PROFIBUS-DP actuators can only be slave devices. Typical slave devices are input/output devices, actuators and plant sensors. They never have bus access, they only acknowledge or reply messages coming from a master.

5.2 Network overview

The media for the fieldbus is a shielded copper cable consisting of a twisted pair. The baudrate for the bus is between 9.6 Kbaud to max. 12 Mbaud. The PROFIBUS-DP network can consist of 99 nodes and the total amount of data for PROFIBUS-DP is 244 Byte out per node and 244 Byte in per node.

NOTE: Node No. 126 is only used for commissioning purposes and should not be used to exchange user data

5.3 Primary functions

PROFIBUS uses a master-slave architecture system in which only the master can initiate a transaction. The slaves respond by supplying the requested data in a reply or by executing the action requested in the query. The PROFIBUS telegram from the master contains the slave address, a function code defining the requested action, a data field, and a CRC field. The PROFIBUS slaves' response message contains fields confirming the requested action and possibly the requested data and also a CRC field. If an error occurs during reception of the telegram or the slave is unable to perform the requested action, the slave will generate an error telegram and send it as response to the master.

5.4 Transfer mode and bus access

RS-485 twisted pair cable. CENTORK actuators support baud rates from 9.6Kbps up to 12Mbps

- Master-slave architecture system
- Mono-master system.
- Master and slave devices: max. 99 devices at one bus (CENTORK actuators supports slave addresses from 0 to 99)

5.5 Technical features for PROFIBUS-DP

The table below gives a summary of the technical features of a PROFIBUS-DP system.

Summary Technical Features for PROFIBUS-DP	
Transmission technique:	EIA RS 485 twisted pair cable or fiber optic
PROFIBUS DIN 19245 Part 1	9.6 Kbit/s up to 12Mbit/s, max. Distance 200m at 1.5 Mbit/s extendible with repeaters
Medium access: Hybrid medium access protocol according to DIN 19245 Part 1	Mono-Master or Multi-Master systems supported
	Master Slave Devices, max. 99 stations possible
Communications: Peer-to-Peer (user data transfer) or Multicast (synchronization)	Cyclic Master-Slave transfer and acyclic Master-Master data transfer
Operation Modes:	Operate: cyclic transfer of input and output data
	Clear: inputs are read and outputs are cleared
	Stop: Only Master-Master functions are possible
Synchronization: enables synchronization of the inputs and/or outputs of all DP Slaves	Sync-Mode: Outputs are synchronized
	Freeze-Mode: Inputs are synchronized
Functionality:	Cyclic user data transfer between DP-Master(s) and DP Slave(s)
	Activation or deactivation of individual DP-Slaves
	Checking of the configuration of the DP-Slaves
	Powerful diagnosis mechanisms, 3 hierarchical levels of the diagnosis messages
	Synchronization of inputs and/or outputs
	Address assignments for the DP-Slaves over the bus with Master class 2
	Configuration of the DP-Master (DPM1) over the bus
Max. 244 bytes input and output data per DP-Slave, typical 32 bytes	
Security and protection mechanisms:	All messages are transmitted with Hamming Distance HD=4
	Watch-Dog Timer at DP-Slaves
	Access protection for the inputs/outputs at the DP-Slaves
	Data transfer monitoring with configurable timer interval at the DP-Master (DPM1)
Cabling and installation:	Connecting or disconnecting of stations without affection of other stations

6 CENTORK PROFIBUS-DP INTERFACE OVERVIEW

This section provides an overview of the PROFIBUS-SP interface of the CENTORK electric actuators with centronik units with PROFIBUS-DP fieldbus.

6.1 Mechanical overview

The interface for Profibus-DP is a slave node that can be read and written to, from a Profibus-DP master. The interface Profibus-DP will not initiate communication to other nodes, it will only respond to incoming commands.

6.2 Protocol & Supported Functions

- Fieldbus type: PROFIBUS-DP V1
- Protocol version: 2.08.02
- Protocol stack supplier: HMS
- Extended functions supported: Diagnostics & User Parameter data.
- Autobaudrate detection. Baudrate range: 9.6 to 12 Mbps
- Save/Load configuration in Flash supported.

6.3 Physical Interface

- Transmission media: PROFIBUS_DP line, type A or B according to RS485 standard.
- Topology: Master-Slave communication
- Fieldbus connectors: Standard Centork connecting terminals, 9 pin female DSUB, on demand.
- Cable: Shielded copper cable, Twisted pair
- Isolation: The bus is galvanically separated from the other electronics with an on board DC/DC converter. Bus signals (A-line and B-line) are isolated via opto-couplers.

6.4 Configuration & Indications

- Address range: 0-99.
- Maximum cyclic I/O data size: 256 bytes in, max 256 bytes out, max.
- Bus termination switch onboard, available.
- LED-indications: ON-line, OFF-line, Fieldbus related diagnostic.

6.5 Data Exchange

- I/O data transmission: The interface only supports cyclic I/O data transmission.

7 MOUNTING TO THE VALVE

7.1 Pre-Installation Inspection

- Verify the actuators nameplate to insure correct model number, torque, operating speed, voltage and enclosure type before installation or use.
- It is important to verify that the output torque of the actuator is appropriate for the torque requirements of the valve and that the actuator duty cycle is appropriate of the intended application.

7.2 Output size

Check whether actuator output flange suits the flange of the valve to be driven. The latter should have been designed following the ISO5210 or ISO5211 standard, for standard application, or following the customer's specifications, for special application.

7.3 Output type

Check that the type of flange coupling of the actuator suits the valve to be driven (diameters and lengths). Those manufactured as Standard at CENTORK follow the ISO5210/5211 standards. Types of output drive:

- **Output type A:** If not otherwise specified in the order, it is supplied blank. The thread must be machined according to the stem of the valve to be driven. For the dismantling and machining of this type of output, see Appendix. Output type A models can withstand axial loads and torque
- **Output type B0, B1, B2, C:** It is supplied machined to the dimensions stated in the ISO 5210/5211 or DIN 3338 standard. For the dismantling and machining of this type of output, see Appendix. Output type B and C models **cannot withstand axial loads.**
- **Output type B3, B4:** It is supplied blank. Output type B models **cannot withstand axial loads.** For the dismantling and machining of this type of output, see Appendix.

7.4 Mounting

- Check size and the type of output match the valve to be driven.
- Degrease the mounting surfaces at actuator and valve thoroughly.
- Slightly grease the input shaft of the valve to be driven.
- Fit the actuator into the valve. In the event of a threaded output (type A), use the handwheel for turning the nut over the threaded stem.
- **Do not lift the actuator by the handwheel.**
- The actuator may be mounted in any position. Before mounting, check proper orientation actuator and valve in order to simplify access to handwheel, switching and terminal compartments (Maintenance and start-up tasks).
- The valve output shaft must be inline with the actuator output drive to avoid side-loading the shaft. To avoid any backlash no flexibility in the mounting bracket or mounting should be allowed.
- Using ISO Class 8.8 quality bolts, fasten crosswise controlling the applied torque according to the table in Appendix

7.5 Frontal panel orientation

Centronik frontal panel position can be changed.

Work at the open actuator under voltage must only be performed if it is assured that for the duration of the work there is no danger of explosion. In other conditions actuator should be carry to a safe area.

- Remove or shut off the centronik main power supply.
- Open the frontal panel by means of the 4 M6 metric bolts.
- Place in the desired position; Check that o-ring sealing is not damaged and the centronik wire which connects the frontal electronic board to main CPU board is not trapped.

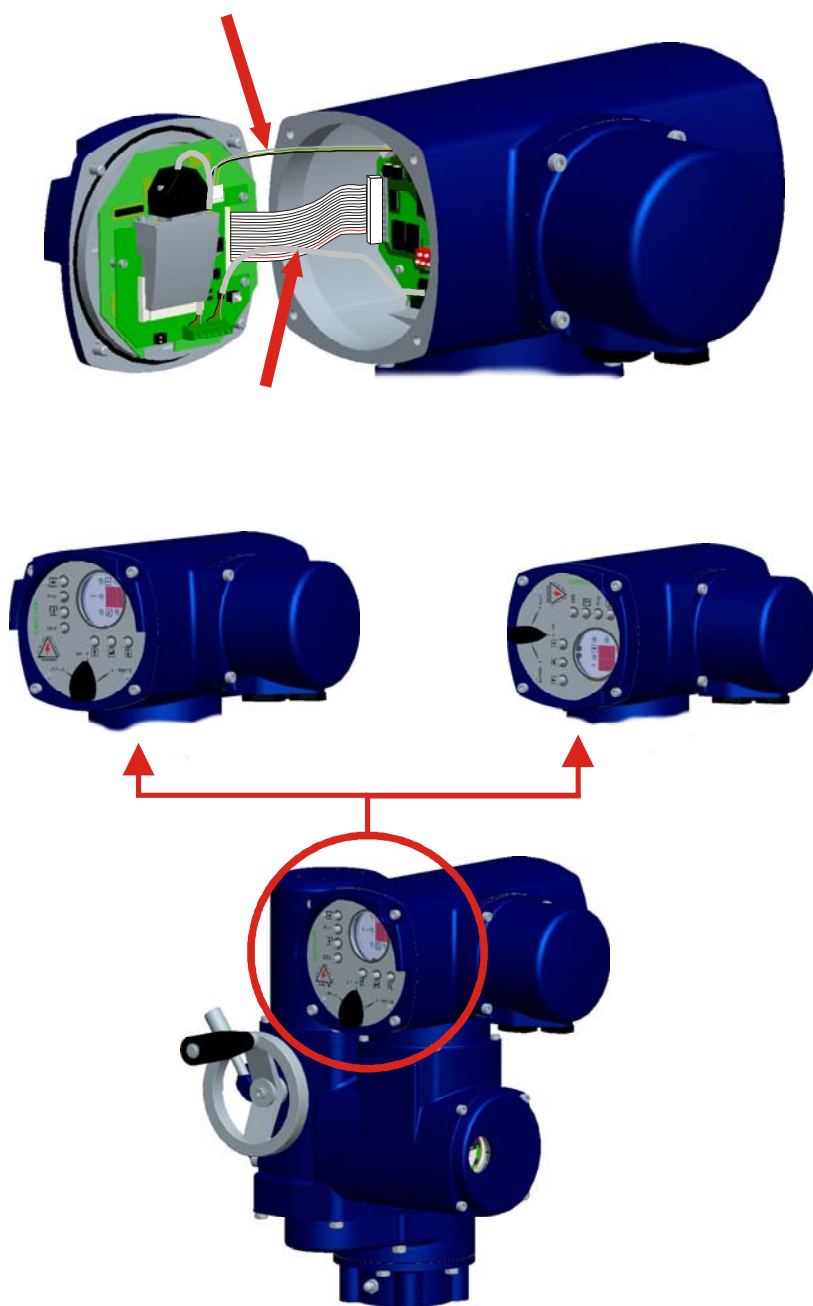

8 ELECTRICAL CONNECTIONS



CAUTION: Safety instructions on chapter 2 must be observed. Work on electrical system or equipment must only be carried out by skilled electrician. Work at the open actuator under voltage must only be performed if it is assured that for the duration of the work there is no danger of explosion. In other conditions actuator should carry to a safe area.

8.1 Wiring diagram (electric manoeuvre)



Electric actuator datasheet, supplied with the actuator, includes a **PROPOSED WIRING DIAGRAM**, delivered with other technical documentation.

Features of electric and electronic components listed on appendix. Wiring diagram are included on appendix.

8.1.1 Duty service

8.1.1.1 ON/OFF duty

Digital input for Remote control:

- OPEN
- CLOSE
- STOP (ALARM RESET)
- DES (UNLOCK)

Characteristics: --.

Setting: --.

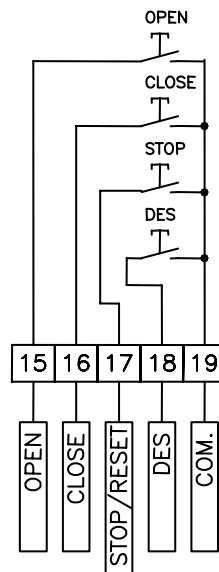

8.1.1.2 Modulating duty

Digital and analogue input for Remote control:

- ESD (Emergency Shut Down)
- RESET (ALARM RESET)
- POSITION (Set position)

Characteristics: Analogue input 220Ω.

Setting: Chapters 12.9.14 and 12.9.8.

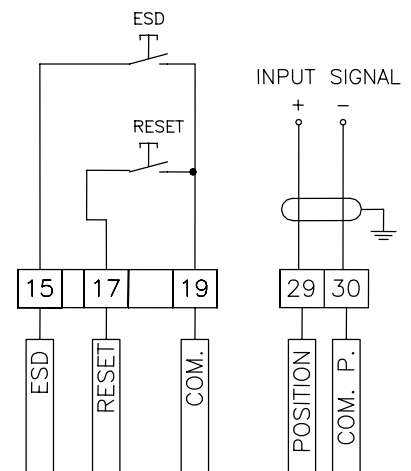

8.1.1.3 ON/OFF duty with position

Digital input for Remote control:

- OPEN
- CLOSE
- STOP (ALARM RESET)
- DES (UNLOCK)
- ESD (Emergency Shut Down)

Characteristics: --.

Setting: Chapter 12.9.8.

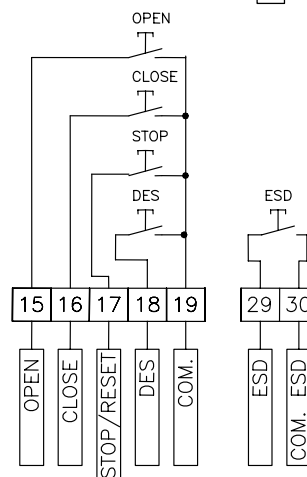

8.1.2 Components

8.1.2.1 Voltage supply

Voltage supply type available:

- 3 phases power supply: 220/240/380/400/420/440/460/500/600V ($\pm 10\%$), 50/60Hz ($\pm 5\%$)
- 1 phase power supply: 110/220/240V ($\pm 10\%$), 50/60Hz ($\pm 5\%$)
- DC power supply: 24VDC ($\pm 20\%$)



Where UPS systems are required, the power supply should have negligible harmonic distortion. In general terms actuators are designed to operate on power supplies conforming to recognised power supply standards such as EN 50160 – Voltage Characteristics of Electricity Supplied by Public Distribution systems.

8.1.2.2 Digital outputs

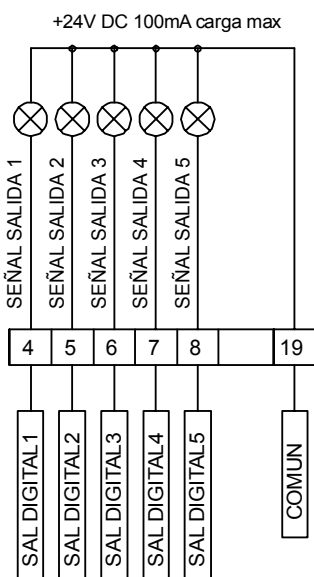

Digital outputs are programmable with the following functions:

- Valve OPEN
- Valve CLOSE
- Overtorque
- Overtorque reached in OPEN
- Overtorque reached in CLOSE
- Motor protection tripped
- Lost phase
- Anomaly
- Command signal failure($< 4\text{mA}$)
- Local selected
- Remote selected
- Intermediate position
- Position reached
- Rest time
- ESD signal

Characteristics: 24VDC, 100mA max.

Setting: Chapter 12.9.5.

8.1.2.3 Relay outputs

MAX: 5A - 30VDC
MAX: 5A - 250VAC /cos $\phi=1$

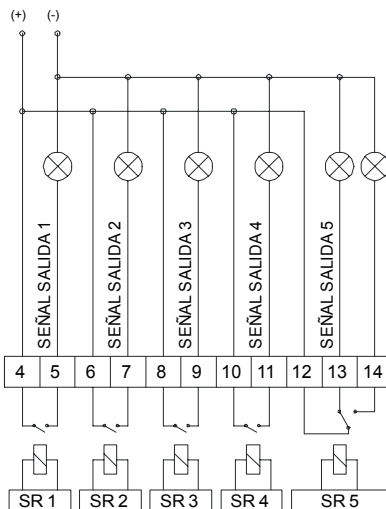

Digital outputs are programmable with the following functions:

- Valve OPEN
- Valve CLOSE
- Overtorque
- Overtorque reached in OPEN
- Overtorque reached in CLOSE
- Motor protection tripped
- Lost phase
- Anomaly
- Command signal failure($< 4\text{mA}$)
- Local selected
- Remote selected
- Intermediate position
- Position reached
- Rest time
- ESD signal

Characteristics:

- SR1 to SR4: 250VAC/24VDC, 5A max.
- SR5: 250VAC/24VDC, 2A max.

Setting: Chapter 12.9.5.

8.1.2.4 Position transmitter

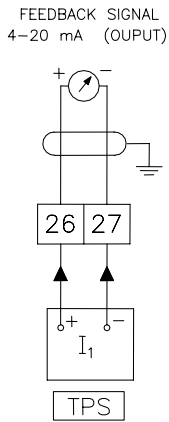

TPS Transmitter gives a signal (Current or voltage) proportional to valve position.

Characteristics:

- Output Signal (current): 2 wires (0/4-20mA), 600Ω Max.
- Optional - Output Signal (voltage): 2 wires (0/2-10V), 1200Ω Min.
- Precision: < 1%.

Setting: Chapters 12.1.4, 12.8 and 12.9.14.

8.1.2.5 Capacitors

Capacitors for single-phase A.C. motors are delivered with electric actuators. In case of external connection, when due to capacitor dimension it is not possible to mount it inside of the centronik unit (Capacitors $C > 30 \mu\text{F}$), capacitors have to be installed on electric cabinet (External), as it is depicted on the actuator terminal plan. Each capacitor is dimensioned according to motor voltage and power. **The electrical actuators with single-phase motors, the capacitors will have to be installed in safety zone. If capacitor has to be in hazardous area, capcitor must be according to a valid way of protection for the zone of use (Hazardous areas)**

8.1.2.6 Fiedl bus

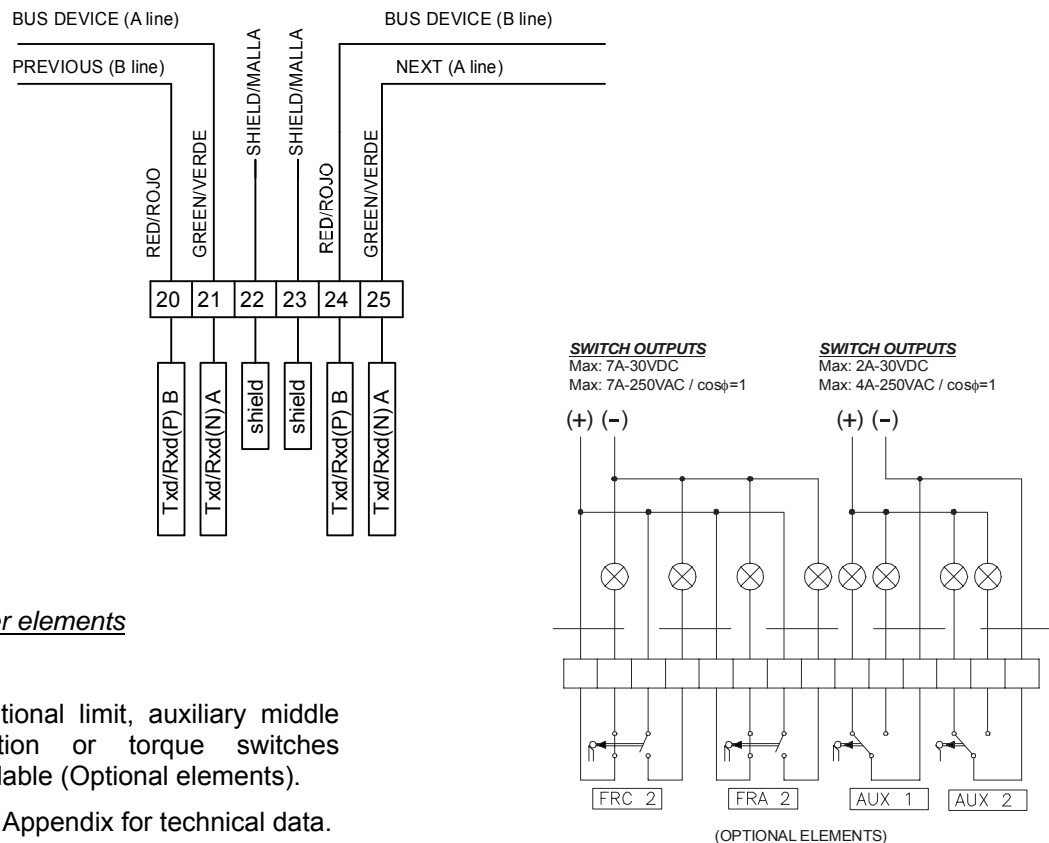

8.1.2.7 Other elements

Additional limit, auxiliary middle position or torque switches available (Optional elements).



See Appendix for technical data.

8.2 Terminal plan and wiring

The electric connection diagram or terminal plan is depicted on Electric actuator datasheet, supplied with the electric actuator, and it can be found printed on a label inside of electrical compartment cover.

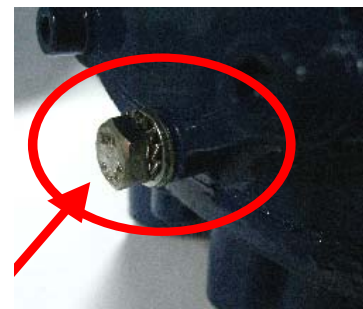
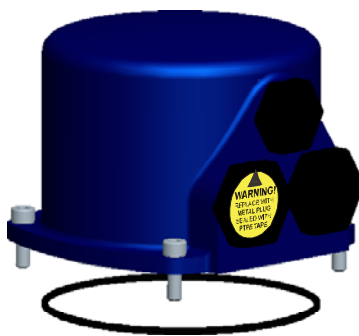
- Open the electrical cover.
- Feed the cable(s) through the cable glands. Fix proper cable glands according to IP67 or IP68 protection degree.
- **Fix proper cable glands according to IP67 or IP68 protection degree. Replace the protection plug with suitable metallic protection plug sealed with PTFE. Tighten cable glands and protection plugs to ensure enclosure IP67 (IP68 if applicable).**



- With a suitable screwdriver (SD 0,6x3,5 DIN 5264-A), connect the cables for the control signals according to the electric connection diagram.
- Connect the **internal earth cable terminal**  to the earth connection located inside of electric connection cover (M5 screw hole) or to earth connection terminal, on actuator terminal blocks.
- Connect the **external earth cable terminal**  to the earth connection terminal (See picture)
- Once you have checked that the connections have been properly carried out, close the connection cover and check the proper connection, the state of the o-ring seal and the proper installation of the latter, greasing it slightly. Fasten the 4 screws crosswise.
- Check that all cable glands are correctly tightened.

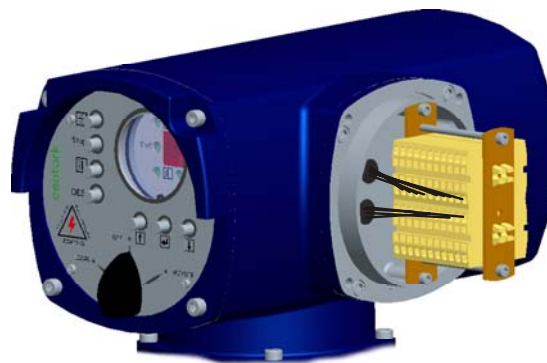
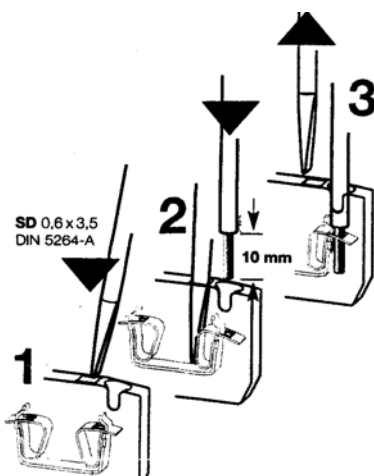

8.3 Cable installation in accordance with EMC



Signal cables are susceptible to interference. Motor cables are interference sources.

- Lay cables being susceptible to interference or sources of interference at the highest possible distance from each other.
- The interference immunity of signal cables increases if the cables are laid close to the ground potential.
- If possible, avoid laying long cables and make sure that they are installed in areas being subject to low interference.
- Avoid long parallel paths with cables being either susceptible to interference or interference sources.
- For the connection of remote signals (Position transmitter, control input, digital output and remote input), screened cables must be used.
- FIELDBUS cable type and execution must be done according to RS485 standards and codes for PROFIBUS-DP.

9 MANUAL OPERATION

CENTORK actuators are fitted with a handwheel for the manual actuation of the valve. In the case of simultaneous motorised and manual working, the motorised one will always be the preferential one, "**motor priority**".



Once the handwheel has been engaged is not possible to disengage, the override engagement lever returns automatically to motor position when the motor is operated. Do not press the lever when motor is running.

Procedure of engagement of manual operation:

- Turn the changeover lever 20° clockwise while slightly turning the handwheel.
- When you notice an increase in the resistance of the wheel, the manual control is engaged.
- Run the valve in the desired direction. Standard sense of rotation is clockwise to close. For greater operating speed you can connect any power tool, pneumatic or electric, to the hand-wheel shaft. The maximum speed allowed is 150 rpm.

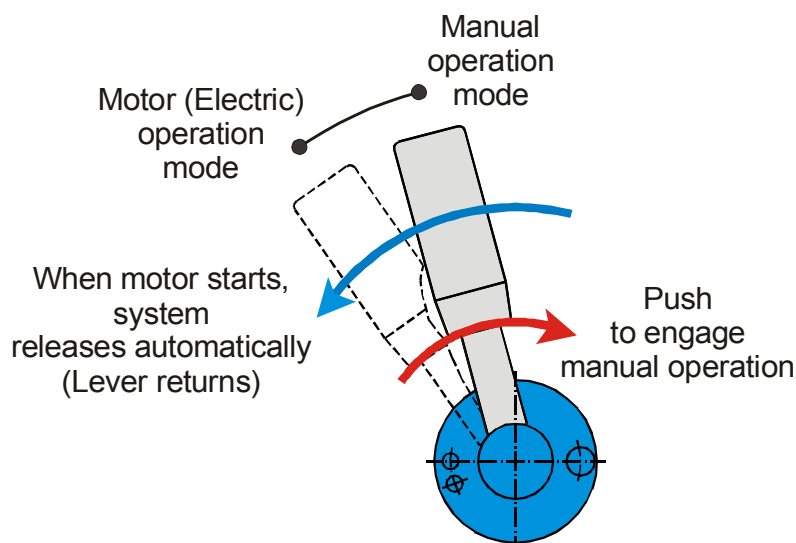
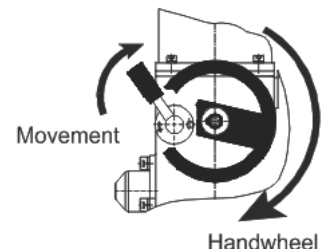

10 LOCAL MODE: CONTROL AND DISPLAYS ELEMENTS

The Centronik unit is equipped with local control:

- Pushbuttons:
 - With the OPEN - STOP – CLOSE pushbuttons, the actuator can be operated locally. Push buttons are self-retaining type.
 - With the UP-ENTER-DOWN pushbuttons, the operator can access to the program menu in order to set/change/configure the different parameters, functions and options.
- The LOCAL - OFF - REMOTE selector allows the control mode to be set.
- 5 indication lights show the actuator status from the front panel (chapter 10.3).
- A display shows the actuator status from the front panel:
 - For ***on-off with display*** and ***modulating*** duties centronik units, the display will indicate the real valve position (%opening)
 - For ***on-off*** duty, **the display will remain turn-off**. Only will be switch on when entering to program mode in order to configure the actuator PROFIBUS_DP parameters, see 12.9.19 chapter.

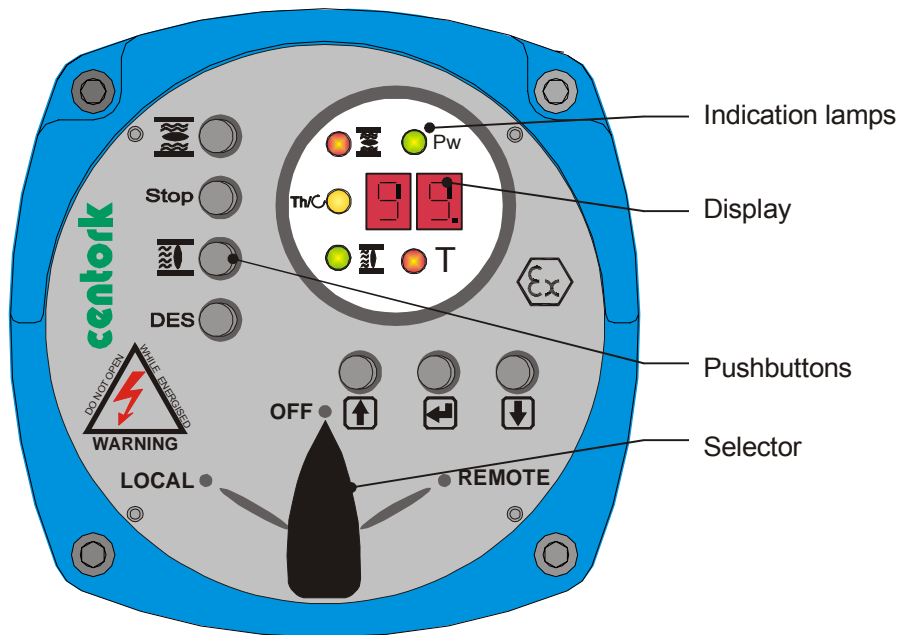

10.1 Lockable selector

The selector LOCAL-OFF-REMOTE is lockable in all three positions. Unauthorized operation at the local controls is therefore prevented.

- **OFF**: In this operation mode, the actuator remains connected but does not responds to any order from the front panel or from the remote control. The front panel control indicates only the power supply status (Led 5).
- **LOCAL**: With the push buttons OPEN-CLOSE-STOP located on the front panel, the actuator is operated locally.
- **REMOTE**: With the remote commands, the actuator is operated remotely (PROFIBUS-DP fieldbus).

10.2 Push-buttons

	OPEN		"UP" scroll/change value
STOP	STOP or ALARM RESET		"ENTER" confirm selection
	CLOSE		"DOWN" scroll/change value
DES	UNLOCK or "ESCAPE"		

10.3 LED indications

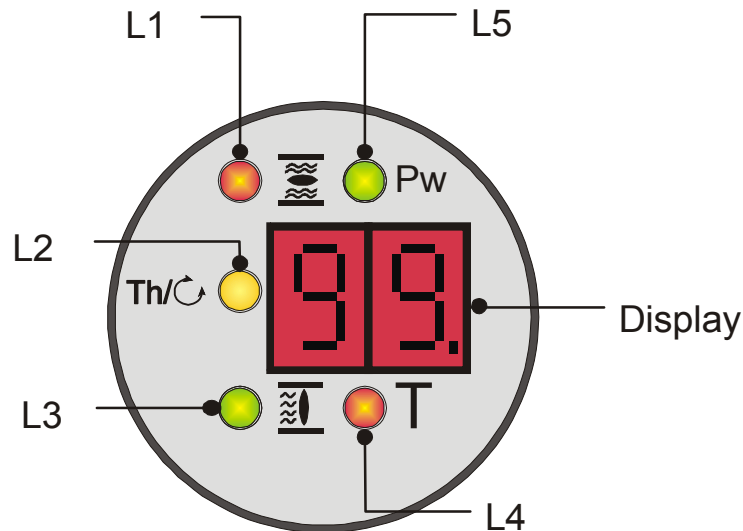

Five local LEDs indicate different signal:

L1	Red: Red blinking: Yellow blinking:	OPEN OPENING Limit switch failure
L2	Red: Red blinking: Yellow: Green:	Motor protection tripped Motor protection tripped and has disappeared Movement fault (blinker or TPS) OFF time executing in Stepping mode
L3	Green: Green blinking: Yellow blinking:	CLOSE CLOSING Limit switch failure
L4	Red: Green: Yellow blinking:	OPEN torque fault CLOSE torque fault Torque switch failure
L5	Green: Red: Yellow:	Correct phase connection Lost Phase Inverse phase connection
L1, L2, L3	Yellow:	Rest time executing

11 SWITCHING AND SIGNALING UNIT



CAUTION: Safety instructions on chapter 2 must be observed. Work at the open actuator under voltage must only be performed if it is assured that for the duration of the work there is no danger of explosion. In other conditions actuator should be carry to a safe area.

Remove 4 bolts and take off the cover at the switching and signalling compartment.



Cover with position indicator



Cover without position indicator

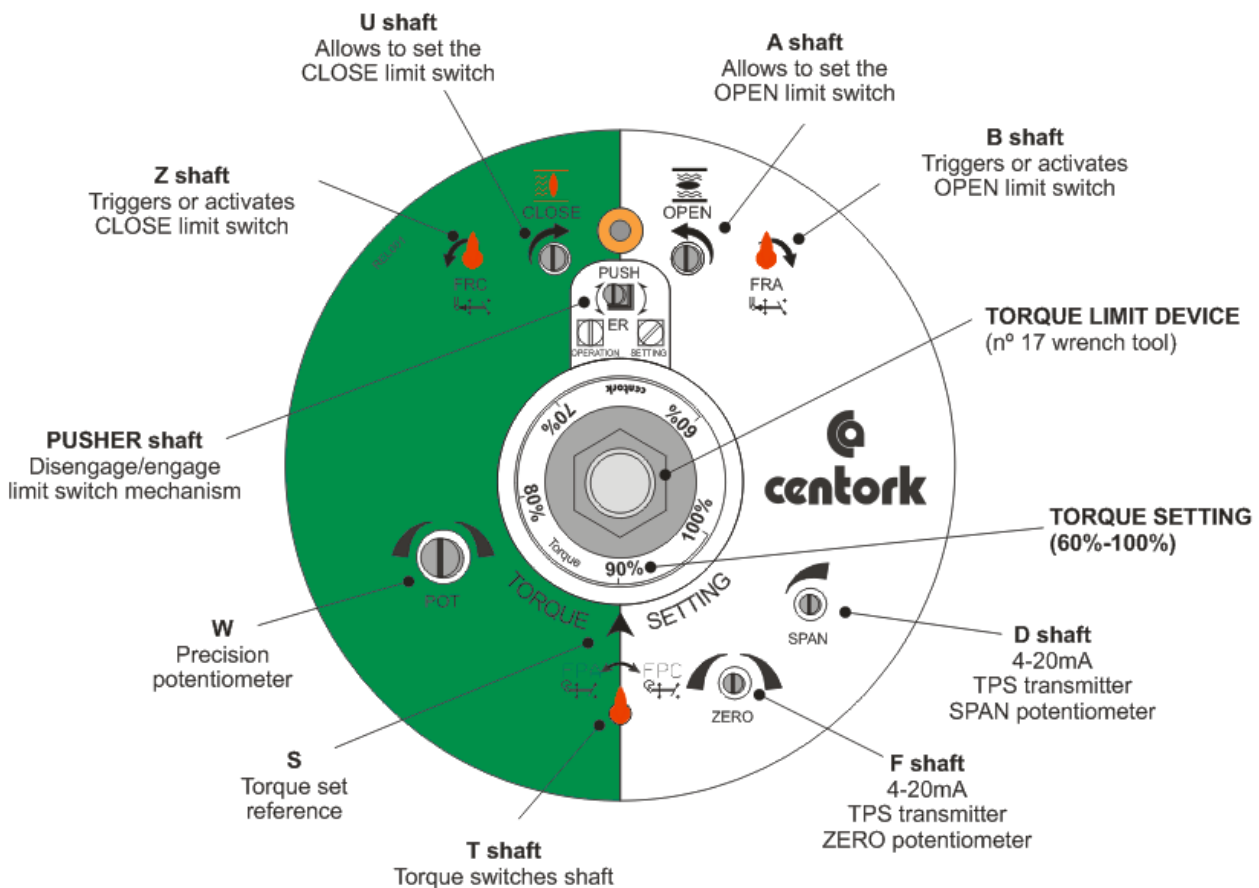

12 SETTINGS AND PRELIMINARY TESTS (START-UP)



CAUTION: Safety instructions on chapter 2 must be observed. Work at the open actuator under voltage must only be performed if it is assured that for the duration of the work there is no danger of explosion. In other conditions actuator should be carry to a safe area.

- Before to start with the preliminary test, actuator should be correctly mounted on valve and correctly wired as well, according to previous 7 and 5 chapters.
- A commissioning routine is recommended (Visual inspection) according to instructions of 3.2.1 chapter.
- It is recommended to move the valve to middle positions before to do any setting or verification described on next chapters. Operate or move the valve manually (Chapter 9) and check that the actuator rotates in the right direction (Visual disc indicator or valve shaft could help for this). Instructions have been made for standard electric actuators: CLOCKWISE TO CLOSE. In case of counter-clockwise valve-actuator, contact CENTORK.



Instructions have been made for standard electric actuators: CLOCKWISE TO CLOSE. In case of counter-clockwise valve-actuator, contact CENTORK.

NOTE: If actuator has been supplied already assembled onto the valve by valve manufacturer, the settings made originally by the manufacturer should NOT be modified on site without the authorisation of the latter, otherwise, serious damage may be caused both to the valve and to the actuator.

- Follow next setting procedure:

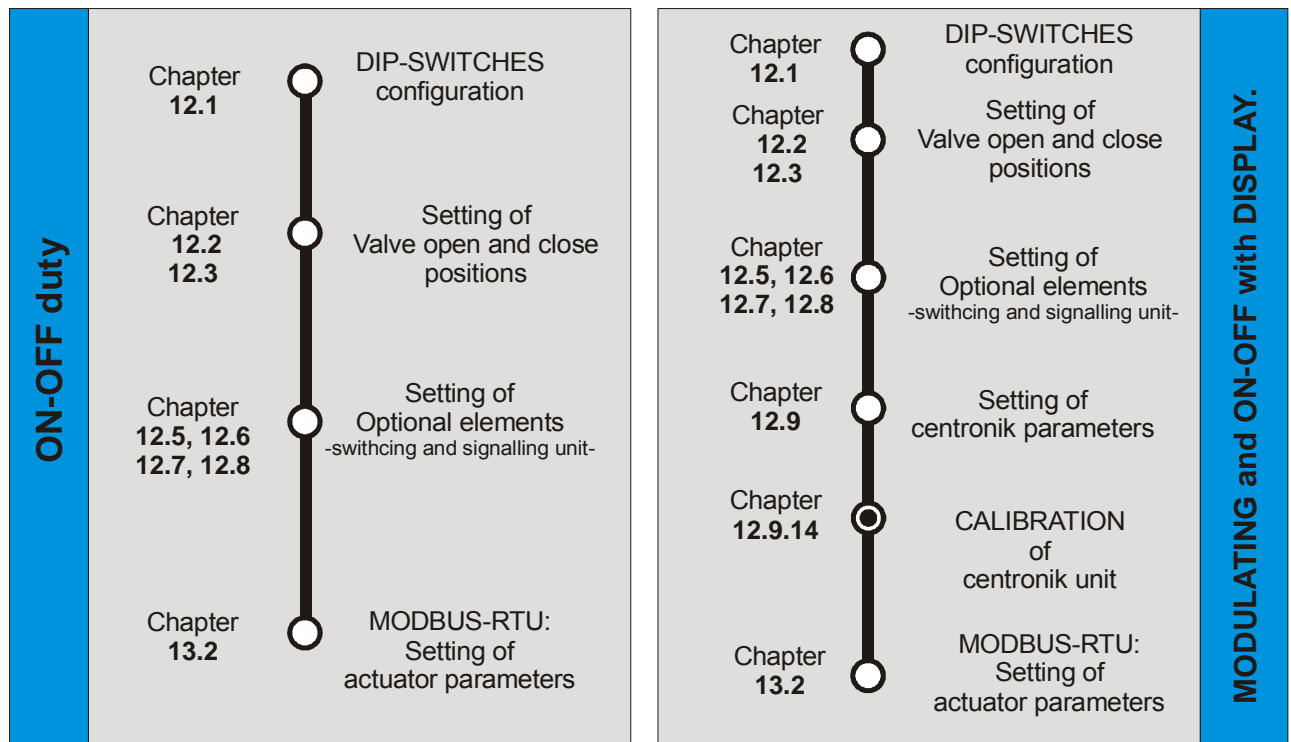

12.1 DIP-SWITCHES configuration

Caution! This is a sensitive electronic device. Manipulation of setting switches should be made very carefully, in a way that other electronic components are not damaged.

In order to configure the Dipswitches, switch-off the Centronik unit (led 5 OFF) and open the centronik front panel carefully. In the CPU board, the DIPSWITCHES are located as indicated in the next figure.

Once the DIPSWITCHES have been configured, close the frontal panel: Check that any wire is not tripped by frontal panel, when closing and verify that o-ring is not damaged or cut. Centronik frontal panel has to be correctly tightened.

CELLS in grey colour: CENTORK FACTORY STANDARD.



12.1.1 Operation mode

SW1	SW2	SW3	Operation mode
ON	OFF	OFF	Open by limit switching and close by torque switching
OFF	ON	OFF	Open and close by limit switching
ON	ON	OFF	Open and close by torque switching

Note: Open or close by torque switching means that the Centronik consider that the valve is closed or opened when the open/close limit switch and the open/close torque switch are activated, otherwise, the Torque signal can be considered as an overtorque condition in middle position. Limit switch must be adjusted as in **Open and close by limit switch**.

12.1.2 Centronik output signals configuration (Only in ON/OFF duty)

SW5	SW6	SW7	OUTPUT 1	OUTPUT 2	OUTPUT 3	OUTPUT 4	OUTPUT 5
OFF	OFF	OFF	Valve OPEN	Valve CLOSE	LOCAL	REMOTE	ANOMALY
ON	OFF	OFF	Overtorque reached in OPEN	Overtorque reached in CLOSE	LOCAL	REMOTE	ANOMALY
OFF	ON	OFF	Valve OPEN	Overtorque reached in CLOSE	LOCAL	REMOTE	ANOMALY
ON	ON	OFF	Valve OPEN	Valve CLOSE	Overtorque reached in OPEN	Overtorque reached in CLOSE	ANOMALY
OFF	OFF	ON	Valve OPEN	Valve CLOSE	Overtorque	Motor overheat (Motor protection tripped)	ANOMALY

Anomaly: Any of the following events: Limit switch fault, torque switch fault, blinker fault, lost phase or Motor thermal protection tripped.

12.1.3 Actuator and valve (Sense of rotation)



Electric actuator and valve sense of rotation must be the same. Electric actuator sense of rotation criteria is **CLOCKWISE TO CLOSE**. Sense of rotation is critical for many components (Microswitches, potentiometer, 4-20mA transmitter). A correct operation cannot be warranty in case of different sense of rotation valve/actuator.

- Operate the Electric actuator via handwheel (See Manual operation, chapter 9).
- Check that running the handwheel clockwise, valve moves to close. If the turn direction is not correct, stop immediately and verify.
- Configure the dipswitch 4.

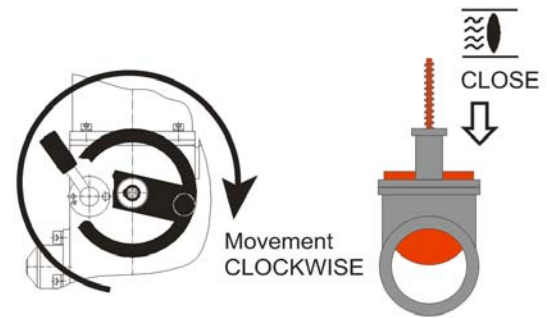

SW4	Direction to close
ON	Anti-clockwise
OFF	Clockwise



Instructions have been made for standard electric actuators: **CLOCKWISE TO CLOSE**. In case of **ANTI-CLOCKWISE** “ON” dipswitch SW4 must be activated, contact **CENTORK**.

12.1.4 Posicion transmitter range (only in Modulating duty and ON/OFF duty with position display)

SW6	TPS range
OFF	0/20mA
ON	4/20mA

Note: the **SW6** must be configured in accordance to the TPS setting (Chapter 12.8).

12.1.5 Remote mode selection

SW8	Remote mode selection
ON	Analogue input control (modulating duty) Parallel input control (ON/OFF duty)
OFF	Fieldbus PROFIBUS-DP

Once the **DIPSWITCHES** have been configured, close the frontal panel: Check that **NO** wire is trapped/damaged by frontal panel, when closing and verify that o-ring is not damaged or cut. Centronik frontal panel has to be correctly tightened.

12.2 Closed position limit switch setting

- Manually turn the valve to the desired CLOSED position.
- Disengaged **PUSHER** shaft (Figure 12.2-2): With a suitable screwdriver press the **PUSHER** shaft 3 mm and turn it 45°, ensure that it does not return to its original height (Figure 12.2-1).
- Note: **PUSHER** shaft allow to engage/disengage the switching and signalling unit from Electric actuator gears. (Figure 12.2-1 and Figure 12.2-2).

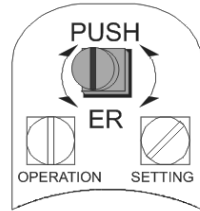

Figure 12.2-1

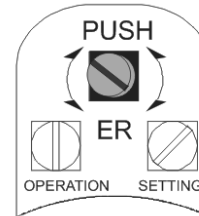

Figure 12.2-2

- Turn **U** spindle clockwise (Figure 12.2-3) until **Z** spindle turns Counter-clockwise (At this moment FRC microswitch triggers). Just before FRC microswitch was tripped, **Z** red arrow should be pointed to vertical: When **Z** spindle (Red arrow) turns to left the FRC microswitch is tripped (Figure 12.2-4).
- If, by accident, it has been carried on turning past the tripping of the FRC microswitch, turn spindle **U** in the opposite direction (counter-clockwise) until the **Z** spindle returns vertical (Figure 12.2-5)

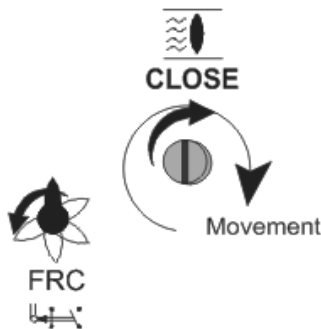

Figure 12.2-3

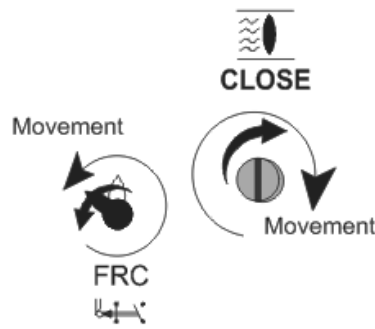

Figure 12.2-4

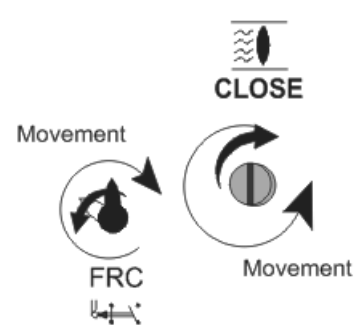

Figure 12.2-5



- **ENGAGE **PUSHER** SHAFT:** Turn back **PUSHER** shaft. Check that goes back to its initial position (Figure 12.2-1). **This point is fundamental for the correct setting of the limit switches: Ensure that **PUSHER** shaft is correctly engaged.**

NOTE: For greater speed in long runs, small electric or pneumatic screwdriver can be used. Max allowable input speed cannot exceed 200 rpm.

12.3 Open position limit switch setting

- Manually turn the valve to the desired OPEN position.
- Disengaged **PUSHER** shaft (Figure 12.2-2): With a suitable screwdriver press the **PUSHER** shaft 3 mm and turn it 45°, ensure that it does not return to its original height (Figure 12.2-1).
- Note: **PUSHER** shaft allow to engage/disengage the switching and signalling unit from Electric actuator gears. (Figure 12.2-1 and Figure 12.2-2).
- Turn **A** spindle Counter-clockwise (Figure 12.3-1) until **B** spindle turns clockwise (At this moment FRA microswitch triggers). Just before FRA microswitch was tripped, **B** red arrow should be pointed to vertical: When **B** spindle (Red arrow) turns to right the FRA microswitch is tripped (Figure 12.3-2).
- If, by accident, it has been carried on turning past the tripping of the FRA microswitch, turn spindle **A** in the opposite direction (clockwise) until the **B** spindle returns to vertical (Figure 12.3-3).

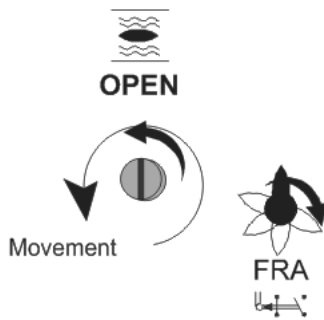

Figure 12.3-1

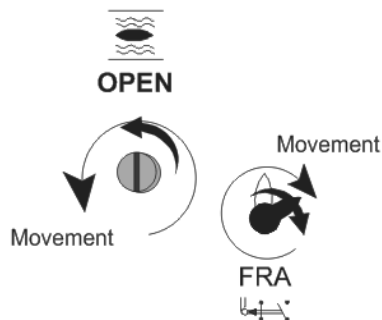

Figure 12.3-2

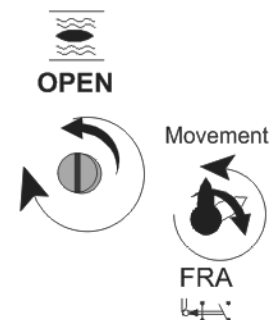

Figure 12.3-3



- **ENGAGE PUSHER SHAFT:** Turn back **PUSHER** shaft. Check that goes back to its initial position (Figure 12.2-1). **This point is fundamental for the correct setting of the limit switches: Ensure that PUSHER shaft is correctly engaged.**

NOTE: For greater speed in long runs, small electric or pneumatic screwdriver can be used. Max allowable input speed cannot exceed 200 rpm.

12.4 Torque switching setting

CENTORK Electric actuators leave the factory tested and set for its Max. Torque (100%), as standard. Adjustment torque range is 60% up to 100% of Max. Torque rated on nameplates.



Guarantee is not valid if the user exceeds this range (60%-100%)

Torque mechanism design

Torque mechanism always acts as soon as actuator output torque exceeds the value set (Torque setting). It is used as protection throughout the whole valve travel. It also remains active during manual operation, thereby protecting the valve from any torque excess caused by the handwheel.

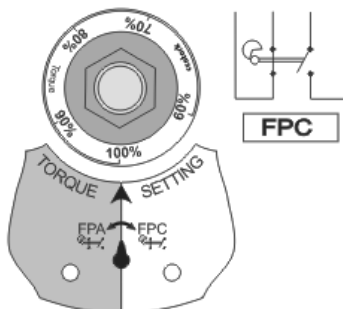

Figure 12.4-1

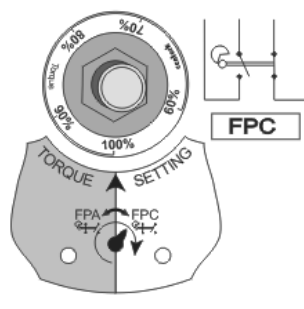

Figure 12.4-2

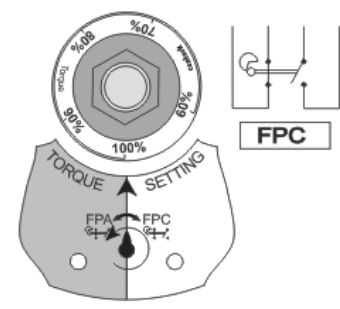

Figure 12.4-3

- When torque on valve shaft exceeds the value set, e.g. running to close, shaft **T** turns to the right (Pointing to FPC), at the same time **TORQUE LIMIT DEVICE** releases (Figure 12.4-1 and Figure 12.4-2). FPC microswitch is tripped. Automatically, or when actuator starts running to opposite direction, mechanism returns or resets. Notice that **TORQUE LIMIT DEVICE** latches again (Figure 12.4-3).

Torque setting Procedure:

- Using a No.17 wrench, turn the **TORQUE LIMIT DEVICE** until the desired torque matches with the arrow **S** on the dial. (Figure 12.4-4 and Figure 12.4-5).

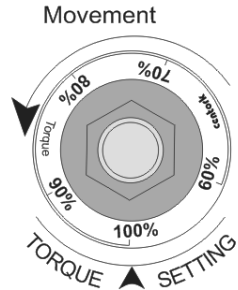

Figure 12.4-4

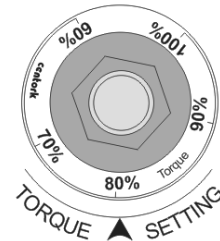

Figure 12.4-5

12.5 Mechanical position indicator setting (optional)

Limit switches must be set before!

Mechanical Position Indication dial turns between CLOSE and OPEN position depending on the model and valve stroke. This is achieved with the addition of a suitable gearing according to the number of turns per valve stroke. If the latter varies, the gearing must be changed.

Procedure:

- Run actuator to the CLOSED position.
- Unscrew the bolt and turn the dial with the symbol (CLOSED) until it matches with the mark ◀ on cover.
- Run actuator to the OPEN position, and proceed exactly with disc containing OPEN symbol.
- Screw the bolt

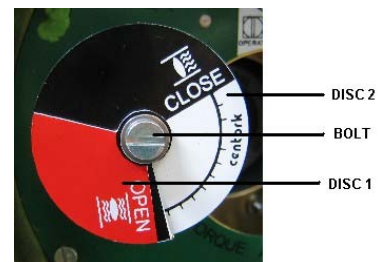

12.6 Auxiliary limit switches setting (optional)

Limit switches must be set before!

Procedure:

- When actuator is fitted with a mechanical position indicator, remove its discs with a screwdriver.
- Run the actuator to the position needed to set auxiliary limit switch AUX1
- With a No. 2 Allen key loosen the bolt in the cam corresponding to the auxiliary limit switch AUX1. Turn this cam until it triggers or trips the limit switch AUX1.
- Work the actuator in both directions, checking that the limit switch AUX1 correctly switches.
- Repeat points 2 to 4 for auxiliary limit switches AUX2, and AUX3.
- If the actuator was fitted with a mechanical position indicator, reinstall it.

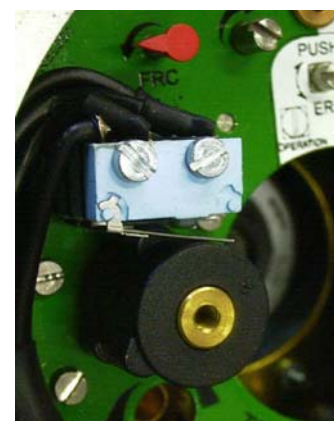

12.7 Potentiometer POT setting (optional)

Limit switches must be set before!

Potentiometer is selected according to valve stroke. A suitable gearing unit reduce valve stroke (Number of turns) to less than one turn, this movement is measured by potentiometer located on switching and signalling unit.

Procedure:

- Run the actuator to the CLOSED position.
- With a suitable screwdriver, turn the **W** spindle of the potentiometer POT, counter-clockwise, to its top end.
- Check that potentiometer value is close to 0 Ohms.
- Run the actuator to the OPEN position.
- Check that potentiometer value reaches its maximum value (Ohms), which depends of the valve stroke.

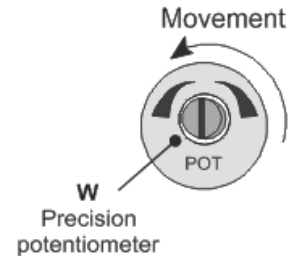

CAUTION: The potentiometer is a high precision electromechanical device and should be handled carefully. It is necessary to use a suitable screwdriver for its setting.

12.8 0/4-20mA transmitter TPS setting (optional)

Modulating and on-off with display centronik units: TPS electronic position transmitter is already included. This element must be adjusted for a correct operation

Limit switches must be set before!

0/4-20 mA transmitter are selected according to valve stroke. A suitable gearing unit reduce valve stroke (Number of turns) to less than one turn, this movement is measured by potentiometer, and converted to current signal by TPS transmitter. If valve stroke changes, TPS may not work properly.

Procedure:

- Run the actuator to the CLOSED position (sensor in minimum signal).
- With a suitable screwdriver, turn the **W** spindle of the potentiometer POT, counter-clockwise, to its top end.
- Adjust the output current with the ZERO (**F** spindle) trimmer potentiometer until its reading is close to 4mA or 0mA
- Run the actuator to the OPEN position (sensor in maximum signal).
- Adjust the output current with the SPAN (**D** spindle) trimmer potentiometer until its reading is close to the maximum current of 20mA.
- Run the actuator back to the CLOSED position and check that the minimum current is 4mA or 0mA. If this is not the case, repeat points 1, 3, 4 and 5 until optimum adjustment values are reached.

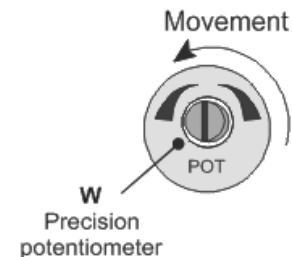

CAUTION: The TPS electronic position transmitter is a high precision electronic device and should be handled carefully. It is necessary to use a suitable screwdriver for its setting.

12.9 CENTRONIK setting procedure (only Modulating and On-Off with display units)

For **on-off with display** and **modulating** duties centronik units, by mean of the program mode it is possible to select and configure the centronik parameters, functions and features.

In order to access to this “program mode” is necessary to switch the centronik selector in LOCAL mode and introduce the correct PASSWORD.

All the setting functions are stored in a non-volatile memory in the CENTRONIK unit. The front panel enables the user to view all the functions via the display, and change it, when required. Notice that there is not a “restore function” when changes are made.

The setting procedure include the following functions:

- Control input signal
- Polarity
- Control input and TPS setting
- Deadband
- Rest time
- Close tightly
- Valve opening curves
- Zero and span for Control input and TPS
- Autolearn
- Digital outputs
- Operation mode Emergency Shut Down
- Blinker
- Data logging
- Password
- Inching mode
- Stepping mode



The setting procedure (See figure on 12 chapter) must be followed in order to adjust/set correctly the Centronik Unit: DIP-switches, Limit switches and optional elements must be set before!

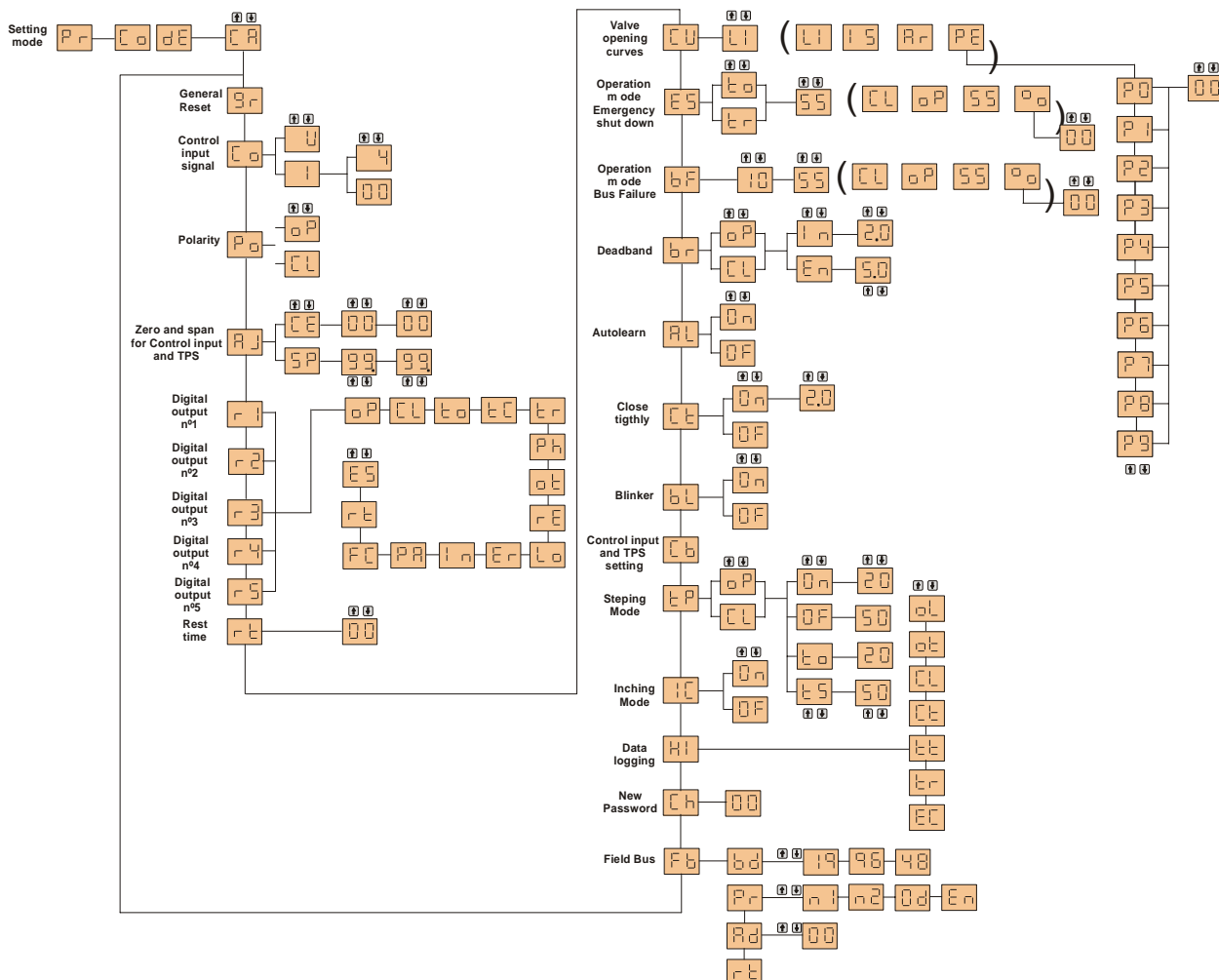









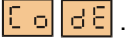

12.9.1 Access to program mode – Password

In order to access to this “program mode” is necessary to switch the centronik selector in LOCAL mode and introduce the correct PASSWORD.

The factory set (default) password is “CA”.

Procedure:











- Press the  key during 3 seconds.
- The display will change to .
- Press the  key.
- The display will change to .
- Press the  key.
- The display will change to .
- Use the  or  keys to scroll through the available password 00-FF (hexadecimal).
- With the correct password display press the  key.
- If the password is incorrect, display will change to . Press the  key and enter the correct password.
- In order to return to the valve position display there are 2 ways: Press the  key or select OFF Control using the selector.

12.9.2 Control input signal (only in Modulating duty)

The modulating duty is a position controller. It compares the input signal and the position transmitter (TPS). The actuator then runs in direction OPEN or CLOSE, subject to the deviation detected. The control input signal is an analogue signal programmed as 0-20mA, 4-20mA or 0-5V (Optional).





The control input signal is factory standard 4-20mA.

Procedure:



- Enter in the setting mode (chapter 12.9.1)
- Press the  or  key to select the Control input signal menu .
- Press the  key.
- The display will change to .
- Use the  or  keys to scroll through the available password 00-FF (hexadecimal). The password will only be provided if necessary. Consult CENTORK.
- With the correct password display press the  key.
- Press the  key.
- Press the  or  key to select the Control input mode:

 Voltage control input  Current control input

Note: Voltage control is an optional control device.

- With the selected mode press the  key.
- Press the  key.
- Press the  or  key to select the Control input range in case of Current control input:

 4-20mA  0-20mA

- With the selected range press the  key.
- Press the  key.

12.9.3 Polarity (only in Modulating duty)

The polarity permit to reverse the control input (or set position) with the actual position comparison.

The Polarity is factory standard CLOSE.

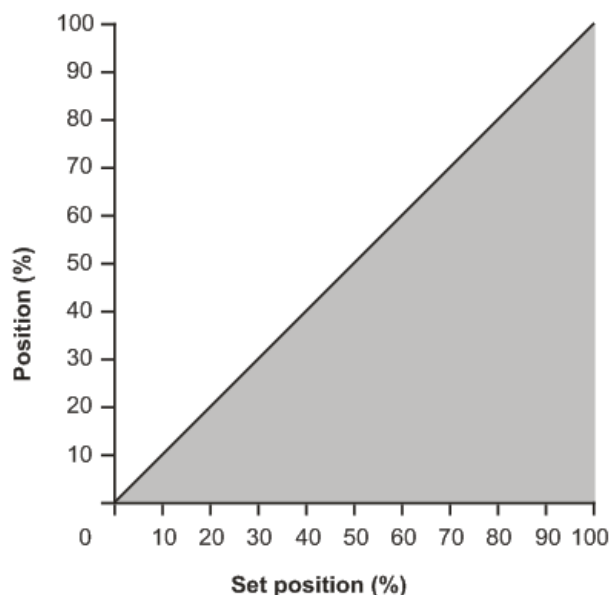



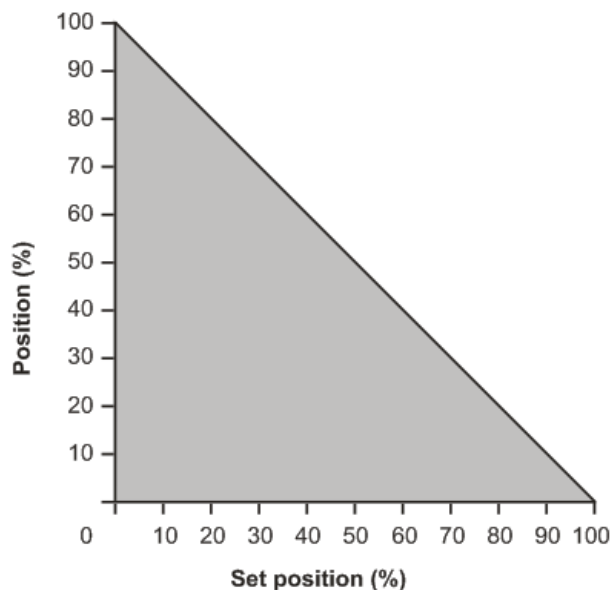







Minimal control input for CLOSE



Minimal control input for OPEN

Procedure:

- Enter in the setting mode (chapter 12.9.1)
- Press the  or  key to select the Polarity menu .
- Press the  key.
- Press the  or  key to select the Polarity mode:
 -  Minimal control input for CLOSE
 -  Minimal control input for OPEN
- With the selected polarity press the  key.
- Press the  key.

12.9.4 Zero and span for Control input and TPS –feedback signal- (only in Modulating duty)

This function enables the control input range (zero, span) to be fitted to the valve stroke and this one to be limited to a given MIN (zero) and MAX (span) percentage. This section is also useful for programming the split-range working mode. Split range allows the adaptation of the positioner to control input ranges which are for example necessary to individually control several actuators with the same control input signal. Typical values for two actuators are 0-10mA and 10-20mA.

The zero for Control input and TPS is factory standard 0%(00). The span for Control input and TPS is factory standard 100% (99.).

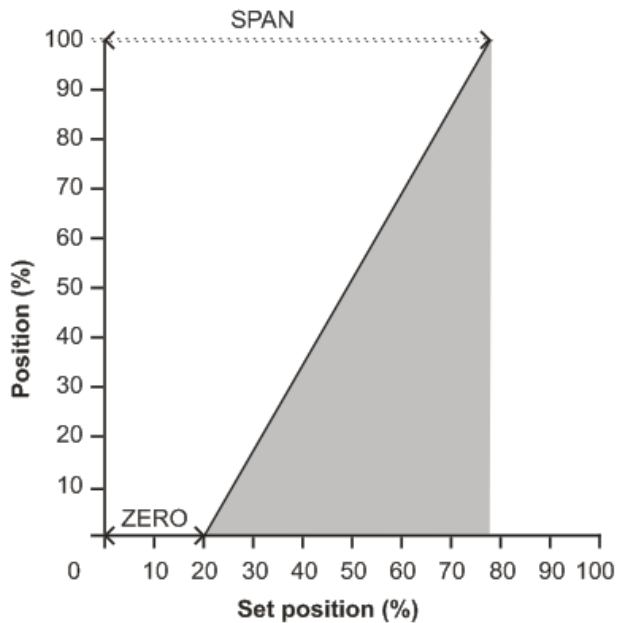



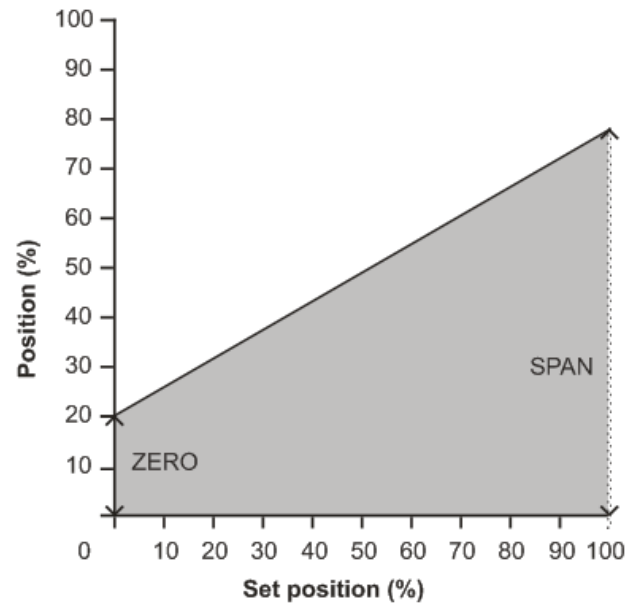





















Zero and span for Set position (Control input)



Zero and span for TPS (position transmitter)

Procedure:

- Enter in the setting mode (chapter 12.9.1)
- Press the  or  key to select the zero and span menu .
- Press the  key.
- The display will change to .
- Press the  key.
- Press the  or  key to select the zero for Control input.
- With the selected value press the  key.
- Press the  key.
- Press the  or  key to select the zero for TPS.
- With the selected value press the  key.
- Press the  key.
- The display will change to .
- Press the  key.
- Press the  or  key to select the span for Control input.
- With the selected value press the  key.
- Press the  key.
- Press the  or  key to select the span for TPS.
- With the selected value press the  key.
- Press the  key.

12.9.5 Outputs signals (Digital or relays outputs)





The digital outputs or Relay outputs indicate the actuator state. Five digital outputs are available and programmable. See Appendix for more details.















Digital outputs R1, R2, R3, R4 and R5 may each be set to trip for the desired function.

The digital outputs is factory standard:



r1 = **oP** **r2** = **CL** **r3** = **ot** **r4** = **rt** **r5** = **tr**

Procedure:

- Enter in the setting mode (chapter 12.9.1)
- Press the  or  key to select the digital outputs menu **r1**.
- Press the  key.
- Press the  or  key to select the required function:

	Valve OPEN		Anomaly
	Valve CLOSE		Remote selected
	Overtorque reached in OPEN		Local selected
	Overtorque reached in CLOSE		Intermediate position
	Motor protection tripped		Position reached (Only in Modulating duty)
	Lost phase (only for 3 phases systems)		Command signal failure (Only in Modulating duty)
	Overtorque		Rest time
			ESD signal (only in Modulating duty and ON/OFF duty with position display)

Anomaly: Motor protection tripped, limit or torque switch fault, movement fault or lost phase.

- With the selected function press the  key.
- Press the  key.

The procedure for setting up digital outputs R2, R3, R4 and R5 are the same as those shown for R1.







12.9.6 Rest time

The rest time is the time after a reach position or OPEN/CLOSE/STOP action that other changes in the nominal value or CLOSE/OPEN action are ignored by the Centronik unit in order to filter major fluctuations within the nominal value and to reduce number of start.

The Rest time prevents the operation to a new nominal position or OPEN/CLOSE action within a predetermine time.

The rest time is factory standard 0s.

Procedure:

- Enter in the setting mode (chapter 12.9.1)
- Press the  or  key to select the Rest time menu **rt**.
- Press the  key.
- Press the  or  key to select between **00** and **60** s.
- With the selected Rest time value press the  key.
- Press the  key.

Note: LEDs 1, 2 and 3 light yellow when the Centronik unit execute the rest time



CAUTION: It must be ensured via the control that the maximum permissible number of starts of the actuator is not exceeded. This can be achieved by setting the rest time to a sufficiently high enough value.

12.9.7 Valve opening curves (only in Modulating duty)

This function enables a transmission characteristic curve with regard to the desired value of set position (Control input) and valve stroke for correction of the flow or operating curve to be chosen.

The Valve opening curves is factory standard Linear.

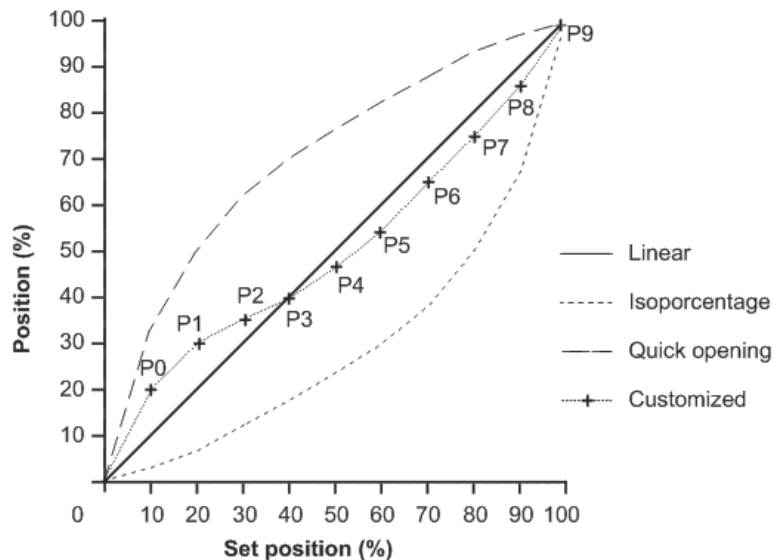

Procedure:

- Enter in the setting mode (chapter 12.9.1)
- Press the or key to select the valve opening curves menu .
- Press the key.
- Press the or key to select the valve opening curve required:
 - Linear opening curve
 - Isopercentage opening curve
 - Quick opening curve
 - Customized opening curve
- With the selected valve opening curve press the key.
- Press the key.
- If the customized opening curve is selected, press the or key to select the valve opening point (P0 to P9.).

Point	P0	P1	P2	P3	P4	P5	P6	P7	P8	P9
Control input (%)	10	20	30	40	50	60	70	80	90	100
Position required (%)										























- Press the key.
- With the selected point value press the key.
- Press the key.
- Repeat this procedure for each valve opening point (P0 to P9.)
- In order to return to previous menu press the .

12.9.8 Operation mode ESD (only in Modulating duty and ON/OFF duty with position display)

In remote mode, an “Emergency Shut Down” signal applied to the actuator will override any existing or applied remote control signal. ESD ignore all securities except the override setting (motor thermostat or torque limit switches).

The factory standard under an active signal is “standstill” position considering motor thermostat.





















Procedure:

- Enter in the setting mode (chapter 12.9.1)
- Press the  or  key to select the ESD menu .
- Press the  key.
- Press the  or  key to select the required ESD override setting:
 Motor thermostat  Torque limit switches
- With the selected ESD override press the  key.
- Press the  key.
- Press the  or  key to select the required ESD action:
 OPEN on ESD  “Standstill” on ESD
 CLOSE on ESD  Reach the ESD desired position (only in Modulating duty).
- With the selected ESD action press the  key.
- Press the  key.
- In case of  action, Use the  or  keys to scroll through the available desired position 00-100.
- With the selected value press the  key.
- Press the  key.

12.9.9 Operation mode “Bus Fail” BF (only in Profibus DP)

In remote mode, a safety operation is only initiated when SW8 OFF (Fieldbus control) and if fieldbus communication fail. The actuator will operate in these conditions according to set BF parameter action. ESD action has priority on BF action.

The factory standard under Bus Failure behaviour is “standstill” position and 10s for BF time.
Procedure:

- Enter in the setting mode (chapter 12.9.1)
- Press the  or  key to select the BF menu .
- Press the  key.
- Press the  or  key to select the required **BF** time between 0 and 100 in 1s step. This parameter determines the time passing between the recognition of a communication error and the initiation of the Bus Failure action.
- Press the  key.
- Press the  or  key to select the required BF action:
 OPEN on ESD  “Standstill” on ESD
 CLOSE on ESD  Reach the BF desired position (only in Modulating duty).
- With the selected BF action press the  key.
- Press the  key.
- In case of  action, Use the  or  keys to scroll through the available desired position 00-100.
- With the selected value press the  key.
Press the  key.

12.9.10 Deadband (only in Modulating duty)

There are two deadbands for each operation sense (opening and closing), the outer deadband and the inner deadband:







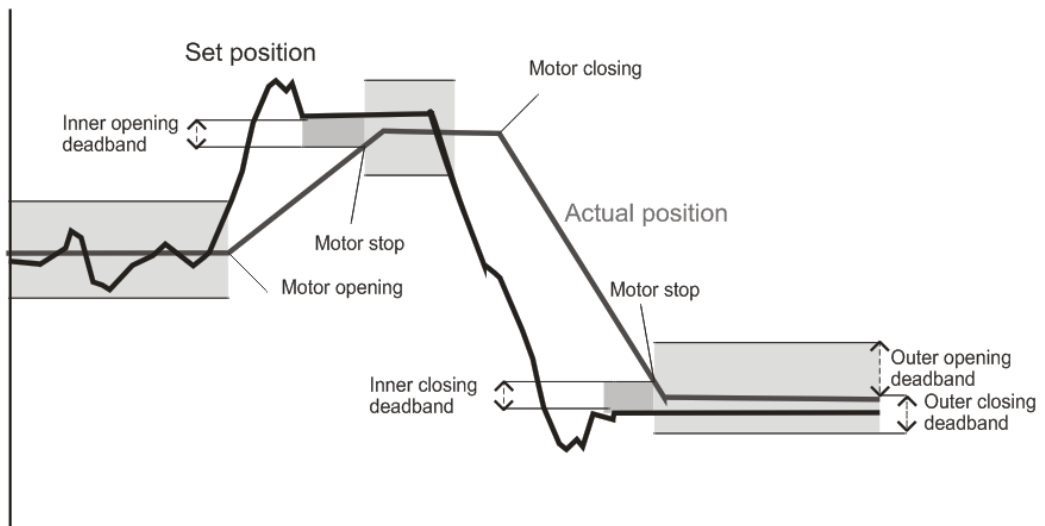











- The outer deadband determines the switching-on point of the actuator.
- The inner deadband determines the switching-off point of the actuator.

The deadband is factory standard 2% for inner deadbands and 5% for outer deadbands.

If the Autolearn menu is activated (ON), it is not necessary to adjust the deadband values.



Procedure:

- Enter in the setting mode (chapter 12.9.1)
- Press the  or  key to select the Deadband menu .
- Press the  key.
- Press the  or  key to select between Opening  and Closing  deadbands.
- Press the  key.
- Press the  or  key to select between Inner  or Outer  deadbands.
- Press the  key.
- Press the  or  key to change the value for the selected deadband between 0,5% and 2,0% for the inner deadband and between 1,0% and 5,0% for the outer deadband in 0,5% step.
- With the selected deadband value press the  key.
- Press the  key.
- In order to return to previous menu press the  key.













CAUTION: Outer deadbands must be greater than inner deadband. If the actuator hunts or responds unnecessarily to a fluctuating set position signal (control input) the deadband must be increased. If more accurate control is required the deadband may be decreased.

12.9.11 Autolearn (only in Modulating duty)

An automatic adaptation of the deadbands is suitable with Autolearn function.

The Autolearn is factory standard OFF (deactivated).

Procedure:

- Enter in the setting mode (chapter 12.9.1)
- Press the  or  key to select the autolearn menu .
- Press the  key.
- Press the  or  key to select between  (autolearn activated) or  (autolearn deactivated).
- With the selected activation/deactivation press the  key.
- Press the  key.















12.9.12 Close tightly (only in Modulating duty)

Close tightly ensures that the actuator opens and closes fully, when activated, it ignores the death bands, near to end positions.

If the nominal value (control input) 0/4 mA or 20 mA for the approaching of the end positions is not reached, a “close tightly” tolerance for the nominal value can be set within the range of the end positions. If the tolerance is exceeded or not reached, the actuator continues the operation until the full end position has been reached.

The close tightly is factory standard OFF (deactivated).

Procedure:











- Enter in the setting mode (chapter 12.9.1)
- Press the  or  key to select the Close tightly menu .
- Press the  key.
- Press the  or  key to select between  (close tightly activated) or  (close tightly deactivated).
- With the selected activation/deactivation press the  key.
- Press the  key.
- If close tightly is activated (ON), press the  or  key to select the close tightly range between 0.5% and 2% in 0,5% step.
- With the selected value press the  key.
- Press the  key.

12.9.13 Blinker (only in Modulating duty and ON/OFF duty with position display)

Blinker transmitter allows detecting movement of the actuator. Blinker detection can be switched on or off. If the detection is switched off, the movement detection is suitable with the position transmitter (TPS).

The blinker is factory standard ON (activated).

Procedure:

- Enter in the setting mode (chapter 12.9.1)
- Press the  or  key to select the blinker menu .
- Press the  key.
- Press the  or  key to select between  (blinker activated) or  (blinker deactivated).
- With the selected activation/deactivation press the  key.
- Press the  key.







12.9.14 Calibration of the CENTRONIK unit (only in Modulating duty and ON/OFF duty with position display)



This function calibrates the centronik unit with the control INPUT signal (user, 20mA) and valve position –feedback signal- given by the electronic position transmitter TPS (20mA): The set point and the actual position (Centronik unit, 100%). This calibration will ensure a correct operation in Remote mode !

Limit switches and 0/4-20mA transmitter must be set before!

Procedure:











- Before making the calibration, the valve should be brought to the maximum opening position, therefore the TPS should be supplying the maximum current (20mA). For modulating duty, the control input signal should be supplying the maximum current (20mA).
- Enter in the setting mode (chapter 12.9.1)
- Press the  or  key to select the Calibration menu .
- Press the  key.
- The display will change to a blinking hexadecimal value.
- Press the  and  key simultaneously to record the calibration. The display will stop blinking.
- Press the  key.

12.9.15 Inching mode (only in ON/OFF duty with position display)

- With **self-retaining operation**, the actuator continues to run as long as the STOP command from the control system (digital input) is not being generated, or any centronik operation condition takes place (Inching mode OFF).
- With **push to run operation (Inching mode)** the actuator continues to run as long as this command from the control system (digital input) remains (Inching mode ON).

The Inching Mode is factory standard OFF (deactivated).

Procedure:

- Enter in the setting mode (chapter 12.9.1)
- Press the  or  key to select the Inching mode menu .
- Press the  key.
- Press the  or  key to select between  (push to run) or  (self-retaining).
- With the selected activation/deactivation press the  key.
- Press the  key.

12.9.16 Stepping mode (only in ON/OFF duty with position display))

The stepping mode is used to increase the operating time for the entire or any portion of the valve travel. Different operating times can be realised without using two-speed motors. Start and end of stepping mode as well as ON and OFF time can be programmed individually for the directions OPEN and CLOSE.

The Stepping Mode is factory standard OFF (deactivated):

- | | |
|----------------|----------------|
| • CL-OFF: 60%. | • ON-OFF: 40%. |
| • CL-ON: 40%. | • ON-ON: 60%. |
| • CL-To: 1s. | • ON-To: 1s. |
| • CL-Ts: 10s. | • ON-Ts: 10s. |

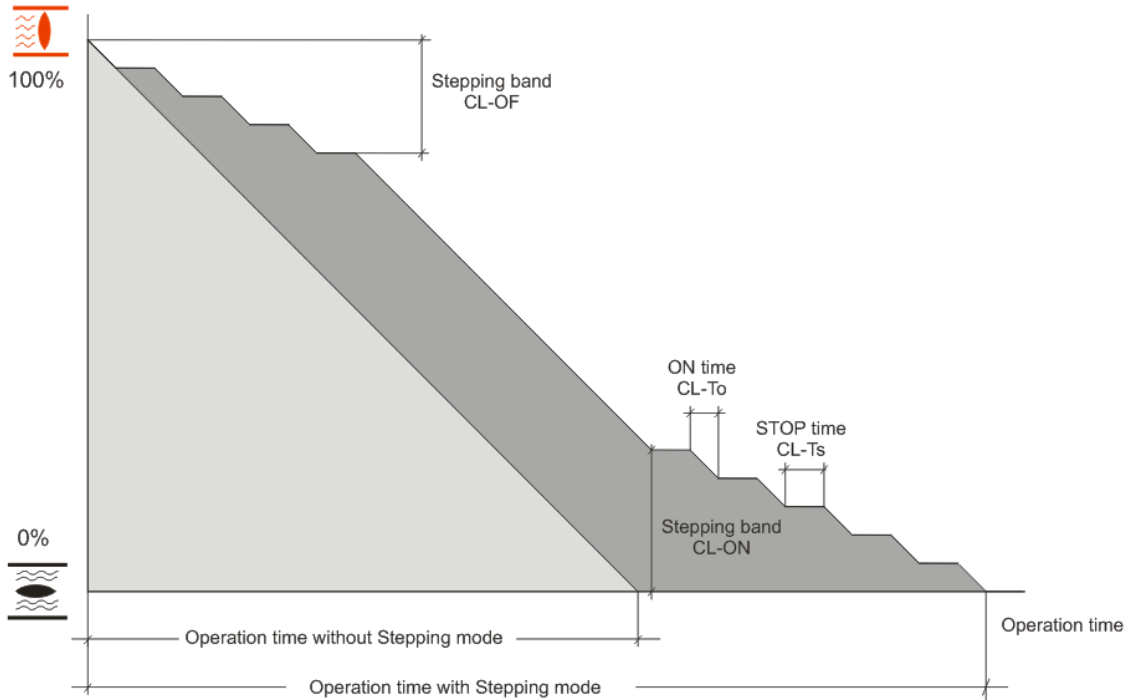



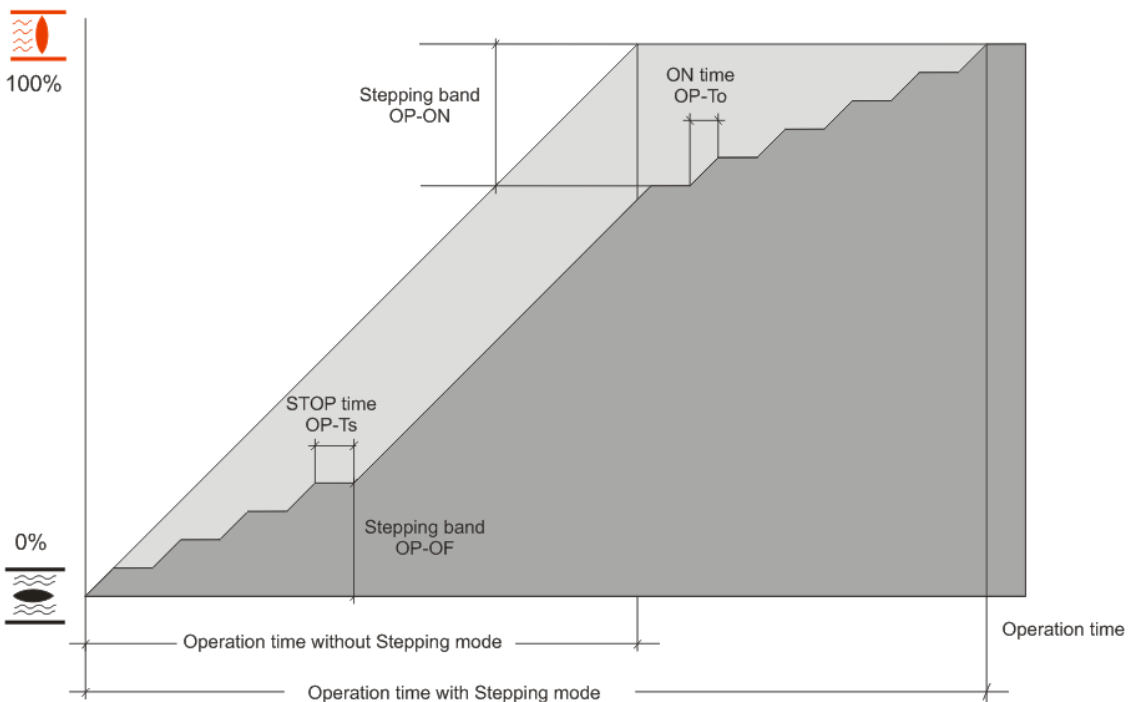























- CL-OF: Direction CLOSE, first stepping operation then normal operation.
- CL-ON: Direction CLOSE, first normal operation then stepping operation.
- CL-To: Running time in direction CLOSE.
- CL-Ts: OFF time in direction CLOSE.



- OP-OF: Direction OPEN, first stepping operation then normal operation.
- OP-ON: Direction OPEN, first normal operation then stepping operation.
- OP-To: Running time in direction OPEN.
- OP-Ts: OFF time in direction OPEN.

Procedure:

- Enter in the setting mode (chapter 12.9.1)

















- Press the  or  key to select the Stepping mode menu .
- Press the  key.
- Press the  or  key to select between  (stepping mode activated) or  (stepping mode deactivated).
- With the selected activation/deactivation press the  key.
- Press the  or  key to select between Opening  and Closing  bands.
- Press the  key.
- Press the  or  key to select between , ,  y .
- Press the  key.
- Press the  or  key to change the value for the selected parameter (0 to 100% for ON and OF parameters in 1% step and 0 to 60s for to and tS parameters in 1s step).
- With the selected value press the  key.
- Press the  key.
- In order to return to previous menu press the  key.



CAUTION: OP-ON must be greater than OP-OF and CL-OF must be greater than CL-ON.







12.9.17 Data logging

Procedure:

- Enter in the setting mode (chapter 12.9.1)
 - Press the  or  key to select the data logging menu .
 - Press the  key.
 - Press the  or  key to select the data logging required.
- | | | | |
|---|---------------------------|---|----------------------|
|  | Nº of opening operations |  | Total running hours |
|  | Nº of open torque faults |  | Nº of thermal faults |
|  | Nº of closing operations |  | Nº of powering |
|  | Nº of close torque faults | | |
- With the selected data logging press the  key.
 - As an example, if the Total running hours is 130012, it will display ""(blank),"13","00","12","""(blank),...
 - Press the  key.
 - In order to return to previous menu press the  key.

12.9.18 New Password

Procedure:

- Enter in the setting mode (chapter 12.9.1)
- Press the  or  key to select the Password menu .
- Press the  key.
- Use the  or  keys to scroll through the desired password 00-FF (hexadecimal).
- Press the  key.



































CAUTION: Password changing is a delicate operation. Write it down and keep it safety. In case of missing, contact CENTORK

12.9.19 Actuator parameters for Fieldbus (PROFIBUS-DP)

The **Fb** Fieldbus mode is used to set the actuator parameters for the FIELDBUS configurations. Those parameters are:

- Baudrate (BD) (Only in MODBUS_RTU)
- Parity (Pr) (Only in MODBUS_RTU)
- Actuator node address (AD)

Procedure:

- Enter in the setting mode (chapter 12.9.1)
- Press  or  to select the fieldbus function 
- Press  to confirm.
- Press the  or  to scroll through the desired parameter.
 - Select Baudrate  and press  .
 - Select the desired Baudrate value.
 - 19200 Bauds  and press 
 - 9600 Bauds  and press 
 - 4800 Bauds  and press 
 - Press  to confirm and store the data.
 - Select Parity  and press  .
 - Select the desired Parity value.
 - No-Parity and 1 bit stop  , then press 
 - No-Parity and 2 bits stop  , then press 
 - Odd Parity and 1 bit stop  , then press 
 - Even Parity and 1 bit stop  , then press 
 - Press  to confirm and store the data.
 - Select actuator (Slave) node address a  , then press  .
 - Select the node address: Range: 0 to 99 , the press 
 - Press  to confirm and store the data.
 - Finally, select the **Reset**  and press  to reboot and update the last changes on actuator parameters for the PROFIBUS-DP.



ATTENTION: Changes on actuator fieldbus parameters only will be updated when RESET function is executed.

13 FIELD BUS (PROFIBUS-DP) CONFIGURATION

13.1 Fieldbus Connector

Depending on the protection class and type of application, other connector designs are also allowed. Contact CENTORK.

Guideline: If the interface should be used with larger data transfer rates than 1500kbit/s, the 9 pin female D-sub connector is recommended to use. The bus connector or terminals are located on the electric compartment (See 8.2 chapter)

13.1.1 Centork connector

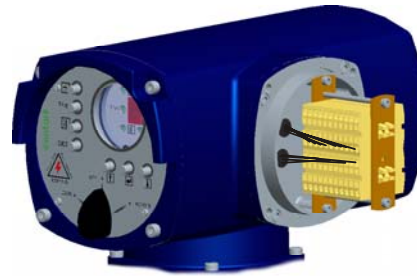
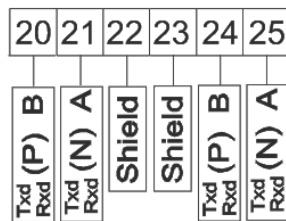

13.2 Configuration

13.2.1 CENTRONIK unit configuration

Make sure that the DIP-SWITCHES of the CENTRONIK UNIT are correctly configured. **Make sure that DIP-SWITCH SW8 is set to OFF for fieldbus control (Chapter 12.1.5).**



13.2.2 Baudrate and Parity

The baudrate and Parity on a PROFIBUS-DP network are set during configuration of the master and only one baudrate is possible in a PROFIBUS-DP installation or network.

The Profibus-DP interface has an auto baudrate detection function and the user does not have to configure the baudrate on the interface. Baudrates supported by the Profibus-DP interface are listed on table.

Baudrates supported by Profibus DP Interface
9.6 kbit/s
19.2 kbit/s
93.75 kbit/s
187.5 kbit/s
500 kbit/s
1.5 Mbit/s
3 Mbit/s
6 Mbit/s
12 Mbit/s

13.2.3 Actuator node address (Slave) configuration

Each actuator (Slave device) on the network has its own (And unique) address. Same address for some actuators causes conflicts on fieldbus communication.

Address range supported by the PROFIBUS-DP interface are: 0 –99 (See 5.5 chapter)

The selected ADDRESS for each actuator (Node) must be set in all actuators (Slave), as described on 12.9.19 chapter).

13.2.4 Termination

The end nodes in a PROFIBUS-DP network has to be “terminated” to avoid reflections on the bus line. The actuator PROFIBUS-DP interface is equipped with a termination switch to accomplish this function in an easy way. If the actuator is used as the last device in the network the termination switch has to be in ON position. Otherwise the switch has to be in OFF position.

Termination switch is located on BUS electronic board, mounted on the Centronik front panel.



Once the termination has been configured, close the frontal panel: Check that any wire is not tripped by frontal panel, when closing and verify that o-ring is not damaged or cut. Centronik frontal panel has to be correctly tighten.

PLEASE NOTE: If an external termination connector is used the switch must be in OFF position.
Warning: An incorrect setting of termination switch may cause problems and Fails on BUS COMUNICATION!

Termination switch ON	Bus termination enabled. If the actuator is the last device, the bus termination has to be set on, or an external termination connector has to be used
Termination switch OFF	Bus termination disabled

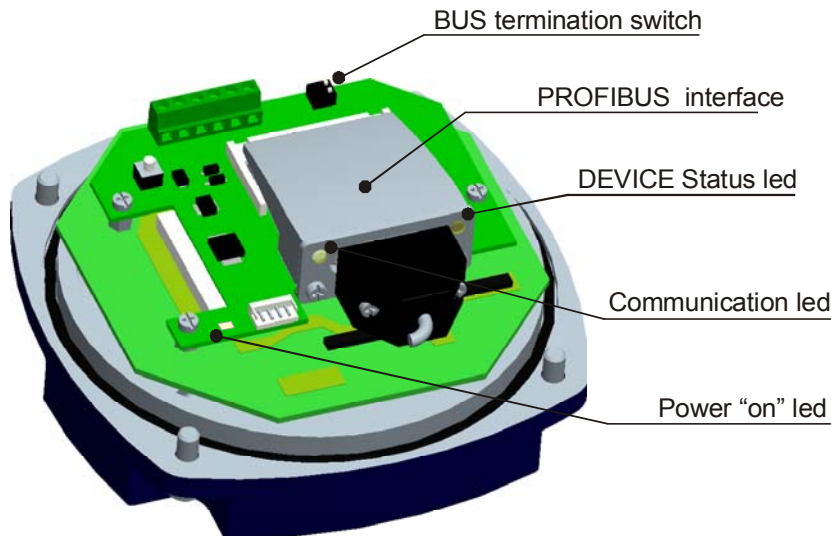

13.2.5 Led Indications of actuator PROFIBUS-DP interface

The PROFIBUS-DP interface is equipped with two LED's mounted at the front, used for debugging purposes. The functions of the LED's are described in the table and figure below.

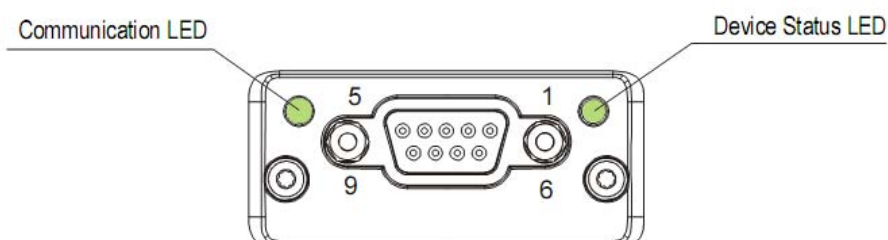

LED	LED colour	Function and meaning
Communication LED	Off	Indicates certain faults on the Fieldbus side
	Yellow	Se ha recibido o enviado una trama de comunicaciones
	Red	Fatal error happened
Device status LED	Off	Initialising or interface no-powered
	Green	Interface initialised correctly, no problems detected
	Red	Internal error
	Red, 1 blinking	Communication Failure or configuration failure Case1: Fieldbus network parameters NO correct Case2: Fieldbus network parameters changed.
	Red, 2 blinkings	Diagnostic function activated.

14 FIELD BUS PROGRAMMING

The fieldbus communication procedure is based on:

The MASTER sends (transmits) some messages in order to write values in some registers (Inputs), that is give orders to slave devices. In that case the reference address

14.1 MODULATING CENTRONIK units

This section describes the input and output data to/from the actuator(Slave device) and the MASTER STATION. They form the communication during the data exchange.

The structure is formed by 22 bytes max. that will be transferred through the PROFIBUS-DP fieldbus.

14.1.1 Master instructions:

- Nominal: This variable is the % of opening the user wants to open the valve.
- The instruction code: This variable is formed by instruction code and the Toggle bit

The possible instruction codes are:

MASTER (Outputs)	↔	CENTORK actuator (Inputs)	<u>Commands</u>
Nominal			0x01 Read STATUS
T		Instruction code	0x02 Read <i>Data logging</i>
			0x04 Read parameter <i>GROUP1</i>
			0x05 Actuator <u>reset</u> in case of alarm.
			0x08 Read parameter <i>GROUP2</i>

14.1.2 Actuator (Slave) response:

- Opening: This variable is the actual % of opening.
- Diagnostic: Alarm codes from the actuator. Possible values are indicated on next chart:
- Instruction code: This variable formed by instruction code and the Toggle bit

CENTORK actuator (Outputs)	↔	MASTER (Inputs)	<u>Diagnostics</u>
% Opening (Valve position)			0x01 Motor protection tripped (Motor overteat)
Diagnostic			0x02 Travel limit switches fault
T		Instruction code/Error code	0x04 Torque limit switches fault
		Data 1	0x08 Lost phase (Power supply)
		Data 2	0x10 Blinker fault
			0x20 ESD signal received
			0x40 Nominal signal (4/20mA) fail
		Data n	

o Response: Instruction code/Error code

The actuator will answer giving back an “echo” and a changed toggle, indicating that the command was correctly processed. If any kind of error occurred in the communication, in the code, etc., an error code will be sent instead of the “echo”. The structure of this code will be:

Error code

- b7:** Toggle
- b6:** Error in instruction code
- b5:** Not used
- b4...b0:** Instruction code

The data bytes, depending on the instruction, are defined as indicated in the next table:

Byte Nr	Status	Parameter Group 1	Parameter Group 2	Data logging
Data 1	DIPSWITCH configuration	Nominal input type	Close tightly	Nr. Open cycles (OP)
Data 2	P1	Nominal input current	Tightly value (%)	Nr. OP + 1
Data 3	P2	Polarity	Bus Fail action	Nr. OP + 2
Data 4	Remote Inputs	Nominal input zero (%)	Bus Fail time	Nr. Close cycles (CL)
Data 5	Remote outputs	Opening zero (%)	Bus Fail Position (%)	Nr. CL + 1
Data 6	Phase	Nominal input span (%)	Curve type	Nr. CL + 2
Data 7	Overtravel Opening	Opening span (%)	Curve P0	Nr. Open Torque cycles
Data 8	Overtravel Closing	Rest time	Curve P1	Nr. OP Torque + 1
Data 9	NOMINAL input (%)	Autolearn	Curve P2	Nr. OP Torque + 2
Data 10	--	Output signal 1	Curve P3	Nr. Close Torque cycles (CL)
Data 11	--	Output signal 2	Curve P4	Nr. CL Torque + 1
Data 12	--	Output signal 3	Curve P5	Nr. CL Torque + 2
Data 13	--	Output signal 4	Curve P6	Nr. Hours
Data 14	--	Output signal 5	Curve P7	Nr. Hours + 1
Data 15	--	Internal DeadBand opening	Curve P8	Nr. Hours + 2
Data 16	--	External DeadBand opening	Curve P9	Nr. thermic trippings
Data 17	--	Internal DeadBand closing	ESD override	Nr. thermic trippings + 1
Data 18	--	External DeadBand closing	ESD action	Nr. powering
Data 19	--	Blinker	ESD Position (%)	Nr. powering +1



The “Command toggle bit” sent must be equal to the “Response toggle bit”. The “Response toggle bit” will be always the opposite of the “Command toggle bit”. When “the Response toggle” bit change, the slave device indicates that the last instruction was received.

14.1.3 Status

The following data will be exchanged when a *Read Status 0x01* instruction is sent.

14.1.3.1 DIPSWITCHES

Indicates the state or configuration of the DIPSWITCHES of the CENTRONIK unit (See 12.1 chapter).

14.1.3.2 P1

Indicates the state of every microswitch located inside the actuator.

P1.0 Closed limit switch (FRC)	P1.4 Blinker (BLK)
P1.1 Open limit switch (FRA)	P1.5 Thermal switch (TRM)
P1.2 Opening overtorque switch (FPA)	P1.6 Lost phase (Only for AC 3PH main power)
P1.3 Closing overtorque switch (FPC)	P1.7 U-V-W phase sequence (Discriminator)

14.1.3.3 P2

Variable only available for CENTORK technicians.

14.1.3.4 Remote inputs

Indicates the state of the remote inputs at the user connector (See 8.1.1 chapter)

14.1.3.5 Remote outputs

Indicates the state of the digital outputs at the user connector (See 12.9.5 chapter).

14.1.3.6 Phase

Indicates the state of the actuator, previous to the byte stream reception.

1. Stop	7. Unlock & Opening	13. Torque limit switch fault
2. Opening	8. Unlock deactivated	14. Lost phase
3. Opened	9. Overtorque opening	15. Blinker fault
4. Closing	10. Overtorque closing	16. Alarm ESD
5. Closed	11. Travel limit switch fault	
6. Unlock & Closing	12. Thermal stop (Overheating)	

14.1.3.7 Overtravel OP

Variable only available for CENTORK technicians.

14.1.3.8 Overtravel CL

Variable only available for CENTORK technicians.

14.1.3.9 Nominal input (%)

Nominal input / set position value (%).

14.1.4 Parameter GROUP1

The following data will be exchanged when MASTER station sends a Read Parameter GROUP 1 instruction **0X04**

14.1.4.1 Nominal input type

This data informs about the nominal input configuration (See 12.9.2 chapter). This data cannot be modified by MASTER. Values for this variable are:

The default value for this parameter is **31**.

Nominal input type	Data 1
Nominal input -Voltage-	30
Nominal input -Current-	31

14.1.4.2 Nominal input –Current-

This data informs about the nominal input (Current) configuration (See 12.9.2 chapter).. This data cannot be modified by MASTER. Values for this variable are:

The default value for this parameter is **32**.

Nominal input (Current)	Data 2
4/20 mA	32
0/20 mA	33

14.1.4.3 Polarity

This data informs about the Polarity configuration (See 12.9.3 chapter).. This data cannot be modified by MASTER. Values for this variable are:

The default value for this parameter is **22**.

Polarity	Data 3
Valve fully close = 4 mA Input signal	22
Valve fully open = 4 mA Input signal	23

14.1.4.4 Nominal input zero –split range- (%)

This data informs about the zero of Nominal input (See 12.9.4 chapter).. This data cannot be modified by MASTER. Values for this variable are:

The default value for this parameter is **0**.

Nominal input zero (%)	Data 4
Value	0-100 %

14.1.4.5 Opening zero (%)

This data informs about % of opening of the valve stroke – feedback signal- for the zero position of the split range setting (See 12.9.4 chapter). This data cannot be modified by MASTER. Values for this variable are:

This parameter refers to the The default value for this parameter is **0**.

Opening zero (%)	Data 5
Value	0-100 %

14.1.4.6 Nominal input span (%)

This data informs about the span of Nominal input (See 12.9.4 chapter).. This data cannot be modified by MASTER. Values for this variable are:

The default value for this parameter is **100**.

Nominal input span (%)	Data 6
Value	0-100 %

14.1.4.7 Opening span (%)

This data informs about % of opening of the valve stroke – feedback signal- for the span position of the split range setting (See 12.9.4 chapter). This data cannot be modified by MASTER. Values for this variable are:

The default value for this parameter is **100**.

Opening span (%)	Data 7
Value	0-100 %

14.1.4.8 Rest time

This data informs about the **Rest Time** parameter configuration (See 12.9.6 chapter). This data cannot be modified by MASTER. Values for this variable are:

The default value for this parameter is **0**

Rest time	Data 8
Value	0-60 s

14.1.4.9 Autolearn

This data informs about the **autolearn** parameter configuration (See 12.9.11 chapter). This data cannot be modified by MASTER. Values for this variable are:

The default value for this parameter is **0**

Autolearn	Data 9
Off	0
On	1

14.1.4.10 Output signals 1, 2, 3, 4 and 5

This data informs about the actuator **output signal** values (See 12.9.5 chapter). This data cannot be modified by MASTER. Values for this variable are:

OUTPUT N°1: The default value for this parameter is **15**.

OUTPUT N°2: The default value for this parameter is **14**.

OUTPUT N°3: The default value for this parameter is **9**.

OUTPUT N°4: The default value for this parameter is **6**.

OUTPUT N°5: The default value for this parameter is **8**.

OUTPUT signals information	Data
Valve opened	15
Valve closed	14
Overtorque opening	13
Overtorque closing	12
Motor protection tripped	11
Lost phase	10
Overtorque	9
Anomaly	8
Actuator in LOCAL mode	7
Actuator in REMOTE mode	6
Actuator in middle position	5
Position reached	4
Input signal missing	3
Resting time	2
ESD	1

14.1.4.11 Inner Dead Band OP (Opening)

This data informs about the **Inner or internal DeadBand OP** parameter configuration (See 12.9.11 chapter). This data cannot be modified by MASTER.

Inner DeadBand OP (Opening)	Data 15
Value	5-20

The value xx in Data 15, will be fixed as the desired value multiplied by ten (e.g. if the internal dead band has to be 1.5% the stroke of the valve, the value at Data 15 will be adjusted to 15). Values for this variable are:

The default value for this parameter is **20**

14.1.4.12 Outer Dead Band OP(Opening)

This data informs about the **Outer or external DeadBand OP** parameter configuration (See 12.9.11 chapter). This data cannot be modified by MASTER.

Outer Dead Band OP (Opening)	Data 16
Value	10-50

The value xx in Data 16, will be fixed as the desired value multiplied by ten (e.g. if the external dead band has to be 3.5% the stroke of the valve, the value at Data 16 will be adjusted to 35). Values for this variable are:

The default value for this parameter is **50**

14.1.4.13 Inner Dead Band CL (Closing)

This data informs about the **Inner or internal DeadBand CL** parameter configuration (See 12.9.11 chapter). This data cannot be modified by MASTER.

Inner Dead Band CL (Closing)	Data 17
Value	5-20

The value xx in Data 17, will be fixed as the desired value multiplied by ten (e.g. if the internal dead band has to be 1.5% the stroke of the valve, the value at Data 17 will be adjusted to 15). Values for this variable are:

The default value for this parameter is **20**

14.1.4.14 Outer Dead Band CL (Closing)

This data informs about the **Outer or external DeadBand CL** parameter configuration (See 12.9.11 chapter). This data cannot be modified by MASTER.

Outer Dead Band CL	Data 18
Value	10-50

The value xx in Data 16, will be fixed as the desired value multiplied by ten (e.g. if the external dead band has to be 3.5% the stroke of the valve, the value at Data 16 will be adjusted to 35). Values for this variable are:

The default value for this parameter is **50**

14.1.4.15 Blinker

This data informs about the **Blinker** parameter configuration (See 12.9.13 chapter). This data cannot be modified by MASTER.

Blinker	Data 19
ON	1
OFF	0

The default value for this parameter is **1**.

14.1.5 Parameter GROUP2

The following data will be exchanged when MASTER station sends a Read Parameter GROUP2 instruction **0X08**

14.1.5.1 Close tightly

This data informs about the **Close tightly** parameter configuration (See 12.9.12 chapter). This data cannot be modified by MASTER.

The default value for this parameter is **0**.

Close tightly	Data 1
ON	1
OFF	0

14.1.5.2 Tightly Value (%)

This data informs about the % **Close tightly tolerance value** parameter configuration (See 12.9.12 chapter). This data cannot be modified by MASTER.

The value xx in Data 2, will be fixed as the desired value multiplied by ten (e.g. if the Tightly Value has to be 4.5% the stroke of the valve, the value at Data 2 will be adjusted to 45).

The default value for this parameter is **50**.

Tightly value (%)	Data 2
Value	50

14.1.5.3 Bus Fail: BF action and BF (%)

This data informs about the **Bus Fail** parameter configuration (See 12.9.9 chapter). This data cannot be modified by MASTER. Possible values for this variable are listed on chart.

This parameter controls the action to do when the bus lines fails in the Fieldbus. The % opening (Data 4) refers to the % of the opening of the valve stroke the actuator will run the valve.

The default value for the **BF action** (Data 3) is **105**

The default value for the **BF%** (Data 4) is **0**.

BF action	Data 3	Data 4
Open	107	
Close	106	
Stand Still	105	
% opening	104	0-100%

14.1.5.4 Bus Fail: BF time

This data informs about the **Bus Fail** parameter configuration (See 12.9.9 chapter). This data cannot be modified by MASTER. This parameter refers to the time after which a bus signal fail will be considered as a Bus Failure error. Possible values for this variable are listed on chart.

The default value for this parameter is **10**.

BF time	Data 5
Value	0-100

14.1.5.5 Valve Opening Curve type

This data informs about the **Valve Opening curve type** configuration (See 12.9.7 chapter).

Curve type	Data 6	Data 7	Data 8	Data 9	Data 10	Data 11	Data 12	Data 13	Data 14	Data 15	Data 16
Linear	43										
Isopercentage	42										
Quick opening	41										
Customized	40	P0	P1	P2	P3	P4	P5	P6	P7	P8	P9

This parameter controls the type of modulation will run the actuator.

In case of "Customized" curve, the P_n (10 values) will be indicated as % of opening, between 10 and 100%. The ten P_n parameters correspond to each 10 % split of the nominal input signal.

The default value for this parameter is **43** and the default value for each P_n is **0**.

14.1.5.6 ESD override

This data informs about the **ESD** parameter configuration (See 12.9.8 chapter). This data cannot be modified by MASTER. Possible values for this variable are listed on chart.

This parameter, controls the actuators protection mode when an ESD signal is received. In “ESD torque tripping” mode, the actuator will stop when a torque signal occurs (but not if thermo-switch tripping). In the “ESD Thermo-switch tripping” mode, the actuator will stop when the Thermo-switches trip (but not if overtorque).

The default value for this parameter is **99**.

ESD override	Data 17
Torque tripping mode	98
Thermo-switch Tripping Mode	99

14.1.5.7 ESD action and ESD (%)

This data informs about the **ESD** parameter configuration (See 12.9.8 chapter). This data cannot be modified by MASTER. Possible values for this variable are listed on chart.

The default value for the ESD action (Data 18) is **101**

The default value for the ESD (%) (Data 19) is **0**.

ESD action	Data 18	Data 19
Open	103	
Close	102	
Stand Still	101	
Percentage open	100	0-100%

14.1.6 Data logging

The following data will be exchanged when MASTER station sends a **Data logging** instruction **0X02**

14.1.6.1 Number of opening operations

Specifies the number of opening cycles. It is a decimal number composed by three two-digits groups: Num Op; Num Op +1; Num Op +2. Whereas Num Op is the most significant two digits, as showed on chart.

Example:

If the number of opening cycles is 215.365 cycles the value of these parameters must be:
Num Op = 21 Num Op +1= 53 Num Op +2= 65

Number of Opening cycles	Data 1	Data 2	Data 3
Value	Num Op	Num Op +1	Num Op +2

14.1.6.2 Number of closing operations

Specifies the number of closing cycles. It is a decimal number composed by three two-digits groups: Num CL; Num CL +1; Num CL +2. Whereas Num CL is the most significant two digits, as showed on chart.

Number of closing cycles	Data 4	Data 5	Data 6
Value	Num Cl	Num Cl +1	Num Cl +2

Example:

If the number of closing cycles is 17.265 the value of these parameters must be:
Num Cl = 01 Num Cl +1= 72 Num Cl +2= 65

14.1.6.3 Number of open torque faults

Specifies the number of open torque faults. It is a decimal number composed by three two-digits groups: Num Op torque; Num Op torque +1; Num Op torque +2. Whereas Num Op torque is the most significant two digits, as showed on chart.

Number of open torque faults	Data 7	Data 8	Data 9
Value	Num Op torque	Num Op torque +1	Num Op torque +2

Example:

*If the number of open torque faults is 20.120 the value of these parameters must be:
Num Op torque =02 Num Op torque +1=01 Num Op torque +2= 20*

14.1.6.4 Number of close torque faults

Specifies the number of close torque faults. It is a decimal number composed by three two-digits groups: Num CL torque; Num CL torque +1; Num CL torque +2. Whereas Num CL torque is the most significant two digits, as showed on chart.

Number of close torque faults	Data 10	Data 11	Data 12
Value	Num CI torque	Num CI torque +1	Num CI torque +2

Example:

*If the number of close torque faults is 215365, the value of these parameters must be:
Num CI torque = 21 Num CI torque +1= 53 Num CI torque +2= 65*

14.1.6.5 Total running hours

Specifies the number of service hours (with the motor running). It is a decimal number composed by three two-digits groups: Num hours; Num hours +1; Num hours +2. Whereas Num hours is the most significant two digits, as showed on chart..

Total running hours	Data 13	Data 14	Data 15
Value	Num hours	Num hours +1	Num hours +2

Example:

If the number of service hours (with the motor running) is 215.365, the value of these parameters must be:

Num hours = 21 Num hours +1= 53 Num hours +2= 65

14.1.6.6 Number of thermal faults

This parameter specifies the number of thermal stops. It is a decimal number composed by two two-digits groups: Num therm. Tripp; Num therm. Tripp. +1. Whereas Num therm. Tripp is the most significant two digits, as showed on chart.

Number of thermal faults	Data 16	Data 17
Value	Num therm. Tripp	Num therm. Tripp +1

Example:

*If the number of thermal tripping is 2153, the value of these parameters must be:
NumTherm. Tripp = 21 Num therm. Tripp +1= 53*

14.1.6.7 Number of powering

Specifies how many times have been powered on the main power supply. It is a decimal number composed by two two-digits groups: Num powering; Num powering +1. Whereas Num powering is the the most significant two digits, as showed on chart..

Number of powering	Data 18	Data 19
Value	Num powering	Num powering +1

Example:

*If the device has been powered on 2153 times, the value of these parameters must be:
Num powering = 21 Num powering +1= 53*

14.1.7 Map of communication: SUMMARY for MODULATING duty

Next chart encloses all WRITE/READ data parameters described previously, for modulating centronik.

DATA	BIT	Device	Address	Mapping word (16bits)	Mapping byte (8bits)	WORD
Nominal (0 ↔100)	0 [^] 15-0 [^] 8	MASTER	0x0000	16 bits (0-15) word 0 to write	Nominal (BYTE)	0
Toggle	0 [^] 7	MASTER				
Read Status	0 [^] 0	MASTER				
Read Historics	0 [^] 1	MASTER				
Read Parameter Group 1	0 [^] 2	MASTER				
Read Parameter Group 2	0 [^] 4	MASTER				
word of 16 bits						
DATA	BIT	Device	Address	Mapping word (16bits)	Mapping byte (8bits)	WORD
Position Feedback	0 [^] 15-0 [^] 8	SLAVE	0x0000	16 bits (0-15) word 0 to read	Position Feedback (BYTE)	0
Nominal signal (4/20mA) fail	0 [^] 6	SLAVE				
ESD signal received	0 [^] 5	SLAVE				
Blinker (Motion) fault	0 [^] 4	SLAVE				
Lost phase	0 [^] 3	SLAVE				
Torque limit switches error	0 [^] 2	SLAVE				
Travel limit switches error	0 [^] 1	SLAVE				
Motor thermal protection tripped (Overheat)	0 [^] 0	SLAVE				
Toggle	1 [^] 15	SLAVE				
Error in instruction code	1 [^] 14	SLAVE				
Echo of instruction code	1 [^] 12	SLAVE	0x0001	16 bits (0-15) word 1 to read	Instruction code/error	1
	1 [^] 11	SLAVE				
	1 [^] 10	SLAVE				
	1 [^] 9	SLAVE				
	1 [^] 8	SLAVE				
	1 [^] 7	SLAVE				
Centronik unit Dip switch 8	1 [^] 6	SLAVE				
Centronik unit Dip switch 7	1 [^] 5	SLAVE				
Centronik unit Dip switch 6	1 [^] 4	SLAVE				
Centronik unit Dip switch 5	1 [^] 3	SLAVE				
Centronik unit Dip switch 4	1 [^] 2	SLAVE				
Centronik unit Dip switch 3	1 [^] 1	SLAVE				
Centronik unit Dip switch 2	1 [^] 0	SLAVE				
Inverse phase connection	2 [^] 15	SLAVE	0x0002	16 bits (0-15) word 2 to read	Data 2 State of switches Will be updated when master sends READ STATUS instruction	2
Lost phase	2 [^] 14	SLAVE				
Motor protection Thermal switch	2 [^] 13	SLAVE				
Blinker	2 [^] 12	SLAVE				
Open torque microswitch	2 [^] 11	SLAVE				
Close torque microswitch	2 [^] 10	SLAVE				
Open limit microswitch	2 [^] 9	SLAVE				
Close limit microswitch	2 [^] 8	SLAVE				
Reserved for future use	2 [^] 7	SLAVE				
Reserved for future use	2 [^] 6	SLAVE				
Reserved for future use	2 [^] 5	SLAVE				
Reserved for future use	2 [^] 4	SLAVE				
Reserved for future use	2 [^] 3	SLAVE				
Reserved for future use	2 [^] 2	SLAVE				
Reserved for future use	2 [^] 1	SLAVE				
Reserved for future use	2 [^] 0	SLAVE				
Remote input 4	3 [^] 11	SLAVE	0x0003	16 bits (0-15) word 3 to read	Data 4 Remote inputs Will be updated when master sends READ STATUS instruction	3
Remote input 3	3 [^] 10	SLAVE				
Remote input 2	3 [^] 9	SLAVE				
Remote input 1	3 [^] 8	SLAVE				
Remote output 5	3 [^] 4	SLAVE				
Remote output 4	3 [^] 3	SLAVE				
Remote output 3	3 [^] 2	SLAVE				
Remote output 2	3 [^] 1	SLAVE				
Remote output 1	3 [^] 0	SLAVE				
word of 16 bits						
State of the actuator: (decimal value)	4 [^] 15-4 [^] 8	SLAVE	0x0004	16 bits (0-15) word 4 to read	Data 6 (BYTE) State of the actuator Will be updated when master send READ STATUS instruction	4
01 : Stop						
02 : Opening						
03 : Opened						
04 : Closing						
05 : Closed						
06 : Unlock&Closing						
07 : Unlock&Opening						
08 : Unlock deactivated						
09 : Overtorque opening						
10 : Overtorque closing						
11 : Travel limit switch fault						
12 : Thermal						
Reserved for future use					4 [^] 7	
Reserved for future use	4 [^] 6	SLAVE				
Reserved for future use	4 [^] 5	SLAVE				
Reserved for future use	4 [^] 4	SLAVE				
Reserved for future use	4 [^] 3	SLAVE				
Reserved for future use	4 [^] 2	SLAVE				
Reserved for future use	4 [^] 1	SLAVE				
Reserved for future use	4 [^] 0	SLAVE				

14.2 ON /OFF with display CENTRONIK units

This section describes the input and output data to/from the actuator (Slave device) and the MASTER STATION. They form the communication during the data exchange.

The message (Data) structure is formed by 22 bytes max. that will be transferred through the PROFIBUS-DP fieldbus.

14.2.1 MASTER instructions

o Control:

This parameter or variable manages the actuator inputs (See 8.1.1.1 chapter). Possible values for this variable are listed on chart:

MASTER (Outputs)	CENTORK actuator (Inputs)	<i>Control</i>	
T	Control	0x01 Close	0x08 Unlock opening
T	Instruction code	0x02 Open	0x10 Unlock closing
		0x04 Stop/Reset	

The toggle bit.

o Instruction code

This data is formed by the instruction code and the Toggle bit. The possible instruction codes are:

0x01 Read Status

0x02 Read Data logging

14.2.2 Actuator (Slave) response:

o Opening: This variable is the actual % of opening.

o Diagnostic: Alarm codes from the actuator. Possible values are indicated on next chart.

o Instruction code: This variable formed by instruction code and the Toggle bit.

CENTORK actuator (Outputs)	MASTER (Inputs)	<i>Diagnostics</i>	
% Opening (Valve position)		0x01	Motor protection tripped (Motor overheat)
Diagnostic		0x02	Travel limit switches fault
T	Instruction code/Error code	0x04	Torque limit switches fault
Data 1		0x08	Lost phase (Only for AC-3PH Power supply)
Data 2		0x10	Blinker fault
Data n		0x20	ESD signal received

o Response :

The CENTRONIK unit will answer giving back an “echo” and a changed toggle, indicating that the command was correctly processed. If any kind of error occurred in the communication, in the code, etc., an error code will be sent instead of the echo. The structure of this code will be:

Error code

- b7:** Toggle
- b6:** Error in instruction code
- b5:** Not used
- b4...b0:** Instruction code

The data bytes, depending on the instruction, are defined as indicated in the next table:

Byte Nr	Status	Data logging
Data 1	DIPSWITCHES configuration	Nr. OP (Opening cycles)
Data 2	P1	Nr. OP + 1
Data 3	P2	Nr. OP + 2
Data 4	Remote inputs	Nr. CL (Closing cycles)
Data 5	Remote outputs	Nr. CL + 1
Data 6	Phase	Nr. CL + 2
Data 7	--	Nr. OP Torque (Open torque trips)
Data 8	--	Nr. OP Torque + 1
Data 9	--	Nr. OP Torque + 2
Data 10	--	Nr. CL Torque (Close torque tips)
Data 11	--	Nr. CL Torque + 1
Data 12	--	Nr. CL Torque + 2
Data 13	--	Nr. Running Hours
Data 14	--	Nr. Hours + 1
Data 15	--	Nr. Hours + 2
Data 16	--	Nr. thermic trippings
Data 17	--	Nr. thermic trippings + 1
Data 18	--	Nr. powering
Data 19	--	Nr. powering +1



The “Command toggle bit” sent must be equal to the “Response toggle bit”. The “Response toggle bit” will be always the opposite of the “Command toggle bit”. When “the Response toggle” bit change, the slave device indicates that the last instruction was received.

14.2.3 Status

The following data will be exchanged when a **Read Status 0x01** instruction is sent.

14.2.3.1 DIPSWITCHES

Indicates the state or configuration of the centronik DIPSWITCHES (See 12.1 chapter).

14.2.3.2 P1

Indicates the state of every microswitch located inside the actuator.

P1.0 Closed limit switch (FRC)	P1.4 Blinker (BLK)
P1.1 Open limit switch (FRA)	P1.5 Thermal switch (TRM)
P1.2 Opening overtorque switch (FPA)	P1.6 Lost phase (Only for AC 3PH main power)
P1.3 Closing overtorque switch (FPC)	P1.7 U-V-W phase secuencia (Discriminator)

14.2.3.3 P2

Variable only available for CENTORK technicians.

14.2.3.4 Remote inputs

Indicates the state of the remote inputs at the user connector (See 8.1.1 chapter)

14.2.3.5 Remote outputs

Indicates the state of the digital outputs at the user connector (See 12.9.5 chapter).

14.2.3.6 Phase

Indicates the state of the actuator, previous to the byte stream reception.

- | | | |
|---------------------|--------------------------------|-------------------------------|
| 1. Stop | 7. Unlock & Opening | 13. Torque limit switch fault |
| 2. Opening | 8. Unlock deactivated | 14. Lost phase |
| 3. Opened | 9. Overtorque opening | 15. Blinker fault |
| 4. Closing | 10. Overtorque closing | 16. Alarm ESD |
| 5. Closed | 11. Travel limit switch fault | |
| 6. Unlock & Closing | 12. Thermal stop (Overheating) | |

14.2.4 Data logging

The following data will be exchanged when MASTER station sends a **Data logging** instruction **0X02**

14.2.4.1 Number of opening operations

Specifies the number of opening cycles. It is a decimal number composed by three two-digits groups: Num Op; Num Op +1; Num Op +2. Whereas Num Op is the most significant two digits, as showed on chart.

Number of Opening cycles	Data 1	Data 2	Data 3
Value	Num Op	Num Op +1	Num Op +2

Example:

If the number of opening cycles is 215.365 cycles the value of these parameters must be:
 Num Op = 21 Num Op +1= 53 Num Op +2= 65

14.2.4.2 Number of closing operations

Specifies the number of closing cycles. It is a decimal number composed by three two-digits groups: Num Cl; Num Cl +1; Num Cl +2. Whereas Num Cl is the most significant two digits, as showed on chart.

Number of closing cycles	Data 4	Data 5	Data 6
Value	Num Cl	Num Cl +1	Num Cl +2

Example:

If the number of closing cycles is 17.265 the value of these parameters must be:
 Num Cl = 01 Num Cl +1= 72 Num Cl +2= 65

14.2.4.3 Number of open torque faults

Specifies the number of open torque faults. It is a decimal number composed by three two-digits groups: Num Op torque; Num Op torque +1; Num Op torque +2. Whereas Num Op torque is the most significant two digits, as showed on chart.

Number of open torque faults	Data 7	Data 8	Data 9
Value	Num Op torque	Num Op torque +1	Num Op torque +2

Example:

If the number of open torque faults is 20.120 the value of these parameters must be:
 Num Op torque =02 Num Op torque +1=01 Num Op torque +2= 20

14.2.4.4 Number of close torque faults

Specifies the number of close torque faults. It is a decimal number composed by three two-digits groups: Num CL torque; Num CL torque +1; Num CL torque +2. Whereas Num CL torque is the most significant two digits, as showed on chart.

Number of close torque faults	Data 10	Data 11	Data 12
Value	Num Cl torque	Num Cl torque +1	Num Cl torque +2

Example:

*If the number of close torque faults is 215365, the value of these parameters must be:
Num Cl torque = 21 Num Cl torque +1= 53 Num Cl torque +2= 65*

14.2.4.5 Total running hours

Specifies the number of service hours (with the motor running). It is a decimal number composed by three two-digits groups: Num hours; Num hours +1; Num hours +2. Whereas Num hours is the most significant two digits, as showed on chart..

Total running hours	Data 13	Data 14	Data 15
Value	Num hours	Num hours +1	Num hours +2

Example:

If the number of service hours (with the motor running) is 215.365, the value of these parameters must be:

Num hours = 21 Num hours +1= 53 Num hours +2= 65

14.2.4.6 Number of thermal faults

This parameter specifies the number of thermal stops. It is a decimal number composed by two two-digits groups: Num therm. Tripp; Num therm. Tripp. +1. Whereas Num therm. Tripp is the most significant two digits, as showed on chart.

Number of thermal faults	Data 16	Data 17
Value	Num therm. Tripp	Num therm. Tripp +1

Example:

*If the number of thermal tripping is 2153, the value of these parameters must be:
NumTherm. Tripp = 21 Num therm. Tripp +1= 53*

14.2.4.7 Number of powering

Specifies how many times have been powered on the main power supply. It is a decimal number composed by two two-digits groups: Num powering; Num powering +1. Whereas Num powering is the most significant two digits, as showed on chart.

Number of powering	Data 18	Data 19
Value	Num powering	Num powering +1

Example:

*If the device has been powered on 2153 times, the value of these parameters must be:
Num powering = 21 Num powering +1= 53*

14.2.5 Map of communication: SUMMARY for ON-OFF with DISPLAY duty

Next chart encloses all WRITE/READ data parameters described previously, for **on-off with display**

DATA	BIT	Device	Address	Mapping word (16bits)	Mapping byte (8bits)	WORD
Unlock closing	0 [^] 12	MASTER	0x0000	16 bits (0-15) word 0 to write	Control Byte	0
Unlock opening	0 [^] 11	MASTER				
Stop / Reset alarms	0 [^] 10	MASTER				
Open	0 [^] 9	MASTER				
Close	0 [^] 8	MASTER				
Toggle	0 [^] 7	MASTER				
Read Status	0 [^] 0	MASTER				
Read Historics	0 [^] 1	MASTER				

DATA	BIT	Device	Address	Mapping word (16bits)	Mapping byte (8bits)	WORD	
Position Feedback	0 [^] 15-0 [^] 8	SLAVE	0x0000	16 bits (0-15) word 0 to read	Position Feedback (BYTE)	0	
ESD signal received	0 [^] 5	SLAVE					
Blinker (Motion) fault	0 [^] 4	SLAVE					
Lost phase	0 [^] 3	SLAVE					
Torque limit switches error	0 [^] 2	SLAVE					
Travel limit switches error	0 [^] 1	SLAVE					
Motor thermal protection tripped (Overheat)	0 [^] 0	SLAVE					
Toggle	1 [^] 15	SLAVE					
Error in instruction code	1 [^] 14	SLAVE	0x0001	16 bits (0-15) word 1 to read	Instruction code/error	1	
Error in control code	1 [^] 13	SLAVE					
Echo of instruction code	1 [^] 12	SLAVE					
	1 [^] 11	SLAVE					
	1 [^] 10	SLAVE					
	1 [^] 9	SLAVE					
Centronik unit Dip switch 8	1 [^] 7	SLAVE					
Centronik unit Dip switch 7	1 [^] 6	SLAVE					
Centronik unit Dip switch 6	1 [^] 5	SLAVE					
Centronik unit Dip switch 5	1 [^] 4	SLAVE					
Centronik unit Dip switch 4	1 [^] 3	SLAVE					
Centronik unit Dip switch 3	1 [^] 2	SLAVE					
Centronik unit Dip switch 2	1 [^] 1	SLAVE					
Centronik unit Dip switch 1	1 [^] 0	SLAVE					
Inverse phase connection	2 [^] 15	SLAVE	0x0002	16 bits (0-15) word 2 to read	Data 2 State of switches Will be updated when master sends READ STATUS instruction	2	
Lost phase	2 [^] 14	SLAVE					
Motor protection Thermal switch	2 [^] 13	SLAVE					
Blinker	2 [^] 12	SLAVE					
Open torque microswitch	2 [^] 11	SLAVE					
Close torque microswitch	2 [^] 10	SLAVE					
Open limit microswitch	2 [^] 9	SLAVE					
Close limit microswitch	2 [^] 8	SLAVE					
Reserved for future use	2 [^] 7	SLAVE					
Reserved for future use	2 [^] 6	SLAVE					
Reserved for future use	2 [^] 5	SLAVE					
Reserved for future use	2 [^] 4	SLAVE					
Reserved for future use	2 [^] 3	SLAVE					
Reserved for future use	2 [^] 2	SLAVE					
Reserved for future use	2 [^] 1	SLAVE					
Reserved for future use	2 [^] 0	SLAVE					
Remote input 4	3 [^] 11	SLAVE	0x0003	16 bits (0-15) word 3 to read	Data 4 Remote inputs Will be updated when master sends READ STATUS instruction	3	
Remote input 3	3 [^] 10	SLAVE					
Remote input 2	3 [^] 9	SLAVE					
Remote input 1	3 [^] 8	SLAVE					
Remote output 5	3 [^] 4	SLAVE					
Remote output 4	3 [^] 3	SLAVE					
Remote output 3	3 [^] 2	SLAVE					
Remote output 2	3 [^] 1	SLAVE					
Remote output 1	3 [^] 0	SLAVE					
State of the actuator: (decimal value) 01 : Stop 02 : Opening 03 : Opened 04 : Closing 05 : Closed 06 : Unlock&Closing 07 : Unlock&Opening 08 : Unlock deactivated 09 : Overtorque opening 10 : Overtorque closing 11 : Travel limit switch fault 12 : Thermal	4 [^] 15-4 [^] 8	SLAVE			0x0004		16 bits (0-15) word 4 to read
Reserved for future use			4 [^] 7	SLAVE			
Reserved for future use			4 [^] 6	SLAVE			
Reserved for future use			4 [^] 5	SLAVE			
Reserved for future use			4 [^] 4	SLAVE			
Reserved for future use			4 [^] 3	SLAVE			
Reserved for future use			4 [^] 2	SLAVE			
Reserved for future use			4 [^] 1	SLAVE			
Reserved for future use	4 [^] 0	SLAVE					

14.3 ON/OFF CENTRONIK units

This section describes the input and output data to/from the actuator (Slave device) and the MASTER STATION. They form the communication during the data exchange.

The message (Data) structure is formed by 10 bytes max. that will be transferred through the PROFIBUS-DP fieldbus.

14.3.1 MASTER instructions

o Control:

This parameter or variable manages the actuator inputs (See 8.1.1.1 chapter). Possible values for this variable are listed on chart:

MASTER (Outputs)	↔	CENTORK actuator (Inputs)	<u>Control</u>	
T		Control	0x01 Close	0x08 Unlock opening
T		Instruction code	0x02 Open	0x10 Unlock closing
			0x04 Stop/Reset	

The toggle bit.

o Instruction code

This data is formed by the instruction code and the Toggle bit. The possible instruction codes are:

0x01 Read Status

14.3.2 Actuator (Slave) response:

- o Diagnostic: Alarm codes from the actuator. Possible values are indicated on next chart.
- o Instruction code: This variable formed by instruction code and the Toggle bit.

CENTORK actuator (Outputs)	↔	MASTER (Inputs)	<u>Diagnostics</u>	
Diagnostic			0x01	Motor protection tripped (Motor overheat)
T		Instruction code/Error code	0x02	Travel limit switches fault
		Data 1	0x04	Torque limit switches fault
		Data 2	0x08	Lost phase (Power supply)
			0x10	Blinker fault
		Data n		

o Response :

The CENTRONIK unit will answer giving back an “echo” and a changed toggle, indicating that the command was correctly processed. If any kind of error occurred in the communication, in the code, etc., an error code will be sent instead of the echo. The structure of this code will be:

Error code

- b7:** Toggle
- b6:** Error in instruction code
- b5:** Not used
- b4...b0:** Instruction code

The data bytes, depending on the instruction, are defined as indicated in the next table:

Byte Nr	Status
Data 1	DIPSWITCHES configuration
Data 2	P1
Data 3	P2
Data 4	Remote inputs
Data 5	Remote outputs
Data 6	Phase
Data 7	--
Data 8	--



The “Command toggle bit” sent must be equal to the “Response toggle bit”. The “Response toggle bit” will be always the opposite of the “Command toggle bit”. When “the Response toggle” bit change, the slave device indicates that the last instruction was received.

14.3.3 Status

The following data will be exchanged when a **Read Status 0x01** instruction is sent.

14.3.3.1 DIPSWITCHES

Indicates the state or configuration of the centronik DIPSWITCHES (See 12.1 chapter).

14.3.3.2 P1

Indicates the state of every microswitch located inside the actuator.

P1.0 Closed limit switch (FRC)	P1.4 Blinker (BLK)
P1.1 Open limit switch (FRA)	P1.5 Thermal switch (TRM)
P1.2 Opening overtorque switch (FPA)	P1.6 Lost phase (Only for AC 3PH main power)
P1.3 Closing overtorque switch (FPC)	P1.7 U-V-W phase secunce (Discriminator)

14.3.3.3 P2

Variable only available for CENTORK technicians.

14.3.3.4 Remote inputs

Indicates the state of the remote inputs at the user connector (See 8.1.1 chapter)

14.3.3.5 Remote outputs

Indicates the state of the digital outputs at the user connector (See 12.9.5 chapter).

14.3.3.6 Phase

Indicates the state of the actuator, previous to the byte stream reception.

- | | | |
|---------------------|--------------------------------|-------------------------------|
| 1. Stop | 7. Unlock & Opening | 13. Torque limit switch fault |
| 2. Opening | 8. Unlock deactivated | 14. Lost phase |
| 3. Opened | 9. Overtorque opening | 15. Blinker fault |
| 4. Closing | 10. Overtorque closing | 16. Alarm ESD |
| 5. Closed | 11. Travel limit switch fault | |
| 6. Unlock & Closing | 12. Thermal stop (Overheating) | |

14.3.4 Map of communication: SUMMARY

Next chart encloses all WRITE/READ data parameters described previously, for on-off centronik.

DATA	BIT	Device	Address	Mapping word (16bits)	Mapping byte (8bits)	WORD
Unlock closing	0^12	MASTER	0x0000	16 bits (0-15) word 0 to write	Control Byte	0
Unlock opening	0^11	MASTER				
Stop / Reset alarms	0^10	MASTER				
Open	0^9	MASTER				
Close	0^8	MASTER				
Toggle	0^7	MASTER				
Read Status	0^0	MASTER			word of 16 bits	
DATA	BIT	Device	Address	Mapping word (16bits)	Mapping byte (8bits)	WORD
Blinker (Motion) fault	0^12	SLAVE	0x0000	16 bits (0-15) word 0 to read	Diagnostic	0
Lost phase	0^11	SLAVE				
Torque limit switches error	0^10	SLAVE				
Travel limit switches error	0^9	SLAVE				
Motor thermal protection tripped (Overheat)	0^8	SLAVE				
Toggle	0^7	SLAVE				
Error in instruction code	0^6	SLAVE				
Error in control code	0^5	SLAVE				
Echo of instruction code	0^4	SLAVE				
	0^3	SLAVE				
	0^2	SLAVE				
	0^1	SLAVE				
	0^0	SLAVE				
Centronik unit Dip switch 8	1^15	SLAVE	0x0001	16 bits (0-15) word 1 to read	Data 1 Dip switches Will be updated when master sends READ STATUS instruction	1
Centronik unit Dip switch 7	1^14	SLAVE				
Centronik unit Dip switch 6	1^13	SLAVE				
Centronik unit Dip switch 5	1^12	SLAVE				
Centronik unit Dip switch 4	1^11	SLAVE				
Centronik unit Dip switch 3	1^10	SLAVE				
Centronik unit Dip switch 2	1^9	SLAVE				
Centronik unit Dip switch 1	1^8	SLAVE				
Inverse phase connection	1^7	SLAVE				
Lost phase	1^6	SLAVE				
Motor protection Thermal switch	1^5	SLAVE				
Blinker	1^4	SLAVE				
Open torque microswitch	1^3	SLAVE				
Close torque microswitch	1^2	SLAVE				
Open limit microswitch	1^1	SLAVE				
Close limit microswitch	1^0	SLAVE				
Reserved for future use	2^15	SLAVE	0x0002	16 bits (0-15) word 2 to read	Data 3 (Reserved for future use) Will be updated when master sends READ STATUS instruction	2
Reserved for future use	2^14	SLAVE				
Reserved for future use	2^13	SLAVE				
Reserved for future use	2^12	SLAVE				
Reserved for future use	2^11	SLAVE				
Reserved for future use	2^10	SLAVE				
Reserved for future use	2^9	SLAVE				
Reserved for future use	2^8	SLAVE				
Remote input 4	2^3	SLAVE				
Remote input 3	2^2	SLAVE				
Remote input 2	2^1	SLAVE				
Remote input 1	2^0	SLAVE				
Remote output 5	3^12	SLAVE	0x0003	16 bits (0-15) word 3 to read	Data 5 Remote outputs Will be updated when master sends READ STATUS instruction	3
Remote output 4	3^11	SLAVE				
Remote output 3	3^10	SLAVE				
Remote output 2	3^9	SLAVE				
Remote output 1	3^8	SLAVE				
State of the actuator: (decimal value) 01 : Stop 02 : Opening 03 : Opened 04 : Closing 05 : Closed 06 : Unlock&Closing 07 : Unlock&Opening 08 : Unlock deactivated 09 : Overtorque opening 10 : Overtorque closing 11 : Travel limit switch fault 12 : Thermal stop 13 : Torque limit switch fault 14 : Lost phase 15 : Blinker stop 16 : Alarm ESD	3^7-3^0	SLAVE	word of 16 bits		Data 6 Remote outputs Will be updated when master sends READ STATUS instruction	

15 TROUBLE SHOOTING

The following instructions are offered for the most common difficulties encountered during installation and start-up.

15.1 Front panel indication fault

- **L1 and L3 yellow blinking:**
 - **Cause:** Limit switch failure. Both limit switches are activated or an opposite limit switch is activated during a CLOSE or OPEN operation.
 - **Solution:**
 - Check the limit switch setting (Chapter 12.2 and 12.3) and SW4 setting (Chapter 12.1.2).
 - Press **STOP** in centronik frontal panel (LOCAL mode) or **STOP** command (REMOTE mode) to reset the anomaly event (Anomaly acknowledgement).
- **L4 yellow blinking:**
 - **Cause:** Torque switch failure. An opposite limit switch is activated during a CLOSE or OPEN operation.
 - **Solution:** Check the SW4 setting (Chapter 12.1.2).
- **L2 yellow:**
 - **Cause:** Movement fault. During a CLOSE or OPEN operation and after 7 seconds, the state of the blinker transmitter not changed, movement is not detected. Switching unit disengaged or motor damaged.
 - **Solution:**
 - Check the limit switch setting (Chapter 12.2 and 12.3) and verify if switching and signalling gears (Pinions and wheels) move as actuator runs.
 - Check if the motor works correctly.
 - Check if actuator can be operated manually by means of the actuator handwheel.
 - Press **STOP** in centronik frontal panel (LOCAL mode) or **STOP** command (REMOTE mode) to reset the anomaly event (Anomaly acknowledgement).
- **L2 red or red blinking:**
 - **Cause:** Motor protection tripped. Duty service exceeds.
 - **Solution:**
 - Check that the valve is correctly lubricated. It must be ensured via the control that the duty service of the actuator is not exceeded. This can be achieved by setting the rest time to a sufficiently high enough value and to increase the deadbands values.
 - Press **STOP** in centronik frontal panel (LOCAL mode) or **STOP** command (REMOTE mode) to reset the anomaly event (Anomaly acknowledgement).
- **L5 red:**
 - **Cause:** Lost Phase.
 - **Solution:**
 - Check if the 3 phases power supply is correct.
- **L5 yellow:**
 - **Cause:** Inverse phase connection. The Centronik unit includes a 3 phases correction system therefore this indication is not an alarm/fault. This is not an anomaly, it is a warning message. The centronik phase-sequence discriminator circuit will correct them automatically, but the LED will turn on in yellow colour.
 - **Solution:** Change the 3 phases sense.
- **L1, L2 and L3 yellow: Rest time executing (Chapter 12.9.6)**

- **L2 green: Stepping mode activated and OFF time executing (Chapter 12.9.16).**
- **All LEDs switch off:**
 - **Cause:** Power supply fault, fuse burned or display board disconnected.
 - **Solution:** Check if the power supply is correct, fuses state and display board connection.

15.2 Actuator does not operate in LOCAL mode

- Check front panel indication fault.
- Check SW1, SW2 and SW3 setting (Chapter 12.1.1).
- Check the connection between the front panel board and the CPU board.

15.3 Actuator does not operate correctly in REMOTE mode

- Check front panel indication fault.
- Check SW8 setting (Chapter 12.1.5).
- In case of analogue input control (Modulating duty), check the correct connection, the SW6 setting (Chapter 12.1.4), and the setting procedure (Chapter 12.9). Check if ESD is not activated.
- In case of parallel control (ON/OFF duty and ON/OFF with display duty), check the correct connection. Check if ESD is not activated.

15.4 Actuator turn in the wrong sense

- Check the SW4 setting (Chapter 12.1.2).

15.5 Digitals outputs does not work

- Check the digitals outputs setting (Chapter 12.9.5).
- Check the correct connection.

16 MAINTENANCE

CAUTION: Safety instructions on chapter 2 must be observed. Work at the open actuator under voltage must only be performed if it is assured that for the duration of the work there is no danger of explosion. In other conditions actuator should be carry to a safe area.

CENTORK actuators are supplied greased from the factory for their lifetime, needing practically no maintenance.

16.1 Commissioning, after the star-up

- Check for damage on paint caused by transport, assembly or handling and repair the damage carefully in order to ensure complete protection against corrosion.
- **Make sure that all the o-ring seals are correctly mounted and that the cable glands are firmly fastened, and protection plug for cable entry not used have been replaced with metallic protection plug sealed with PTFE tape, in order to ensure the IP67, IP68 protection.**
- Check that switching and signalling cover and connection cover screws are correctly fastened.
- **Check the correct tightening of the bolts between the actuator and the valve.**
- Check the correct greasing of the gear housing.
- The most important condition for reliable service of the CENTORK actuators is the fact of having carried out a correct commissioning and set-up procedure.

16.2 Maintenance for service

CENTORK recommends for a preventive maintenance programme. Approximately 3 months after commissioning and then every 9/12 months:

- **Check the correct tightening of the bolts between the actuator and the valve.**
- **Take advantage of each revision to check the proper tightening of the covers, of the handwheel lock and the external electric connection.**
- **Check cable entries.**
- **Visual inspection inside of switching and signalling, and electrical compartments.**
- Contact with valve manufacturer in order to know about maintenance routines of valve.
- In the event of infrequent service, perform a test run every 6 months in order to ensure the availability of service of the actuator.

16.3 Electric actuator's service life

- Electric actuator service life is rated to 20.000 cycles.
- Each cycle is formed by an opening manoeuvre (Valve close position to valve open position) and a closing manoeuvre (Valve open position to valve close position).
- 50 turns has been considered as standard valve stroke reference.

16.4 Fuse replacement

- Fuse replacement and works on HAZARDOUS AREAS only can be done when no presence of explosive atmosphere or gas. Otherwise, actuator must be removed and taken to a safe area
- The Centronik unit presents 2 fuses. In order to replace the fuses SAFETY INSTRUCTION must be observed (Chapter 2).
- With power off, open the electrical cover and the explosion proof cover.
- Open the fuse holders and replace the fuses according to the table below.

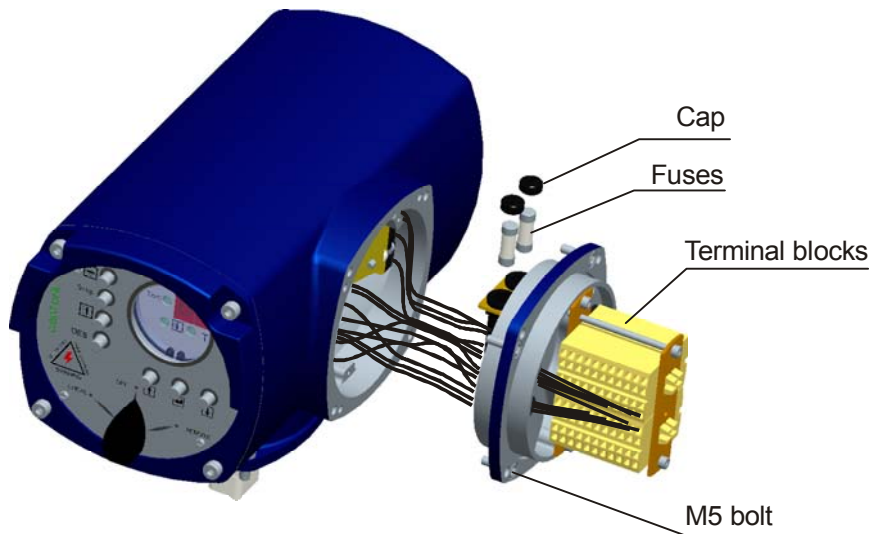

TENSION	CARACT. FUSE
24VDC	5A (5X20mm)
110/120VAC	2A (5X20mm)
220/230VAC	1A (5X20mm)

TENSION	CARACT. FUSE
380 to 440 VAC	500mA (6.3X32mm)
460 to 600 VAC	250mA (6.3X32mm)

- Once you have checked that the fuse holders have been properly carried out and the state of the o-ring seal, close the explosion proof cover. Fasten the 4 screws crosswise.
- Close the electrical cover and check the proper connection, the state of the o-ring seal and the proper installation of the latter, greasing it slightly. Fasten the 4 screws crosswise.

17 TECHNICAL SUPPORT

Each actuator is supplied with a datasheet on A4 format. The following is included:

- The nameplates attached to the actuator.
- Electric actuator datasheet.
- The electric connection diagram for each actuator (also stuck inside the connections cover of the actuator).
- This electric actuator user manual.

For any claim or information request, the SERIAL NUMBER included on this datasheet or on the Electric actuator nameplates should be used.

Electric actuator manufacturer address: See on Manual covers.

18 LIST OF SPARE PARTS

18.1 Actuator unit

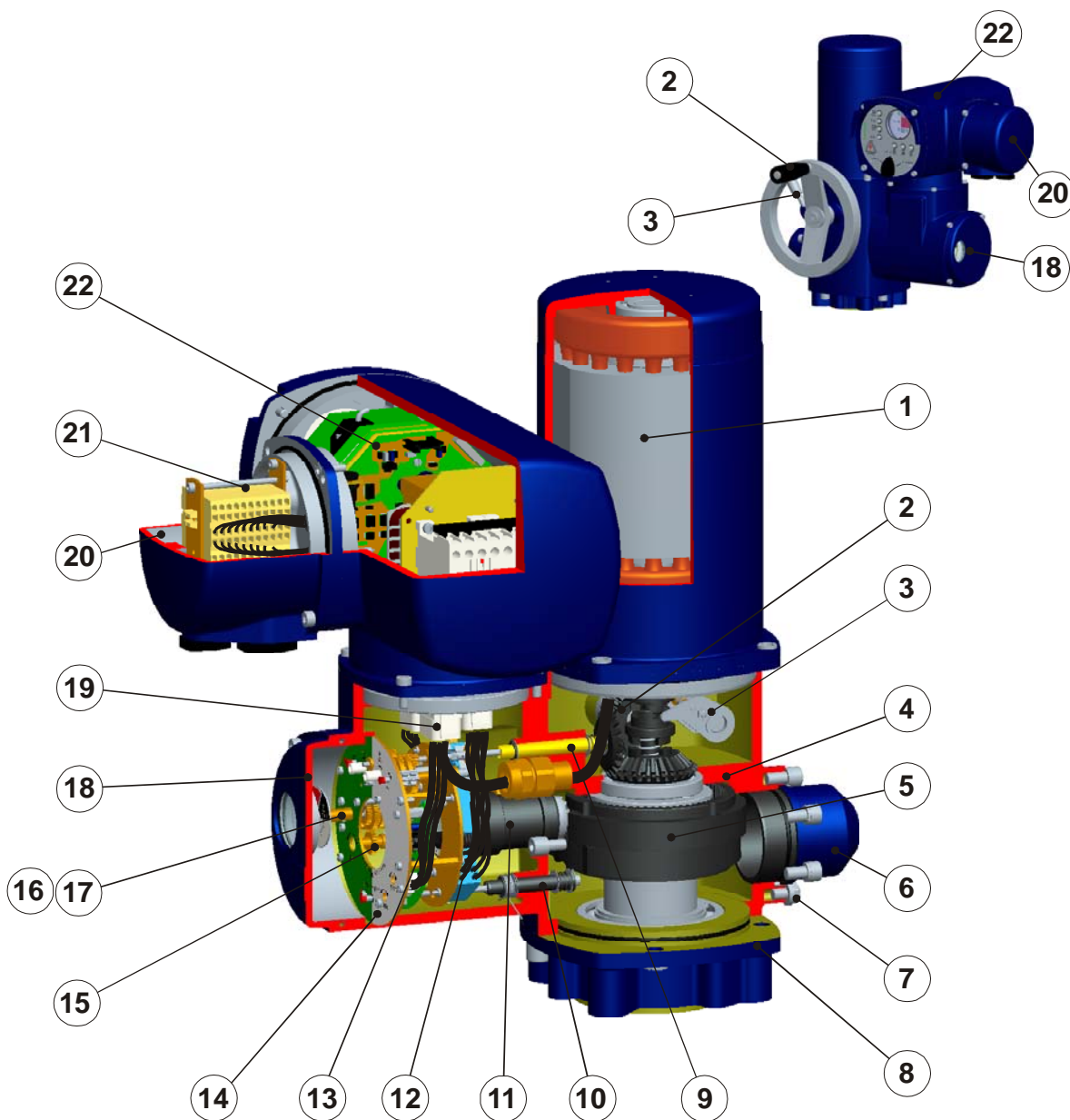

Electric actuators, 40C series					
Mark	Description	QTY	Mark	Description	QTY
1	Flame-proof electric motor	1	12	Anti-condensation	1
2	Handwheel and manual shaft subassembly	1	13	TPS electronic position transmitter	1
3	Override and declutch lever subassembly	1	14	Switching and signalling unit	1
4	Housing	1	15	Potentiometer subassembly	1
5	PTCS planetary subassembly	1	16	Gearing unit subassembly	1
6	Energy absorber springs subassembly	1	17	Visual indicator subassembly	1
7	External ground earth terminal	1	18	Switching and signalling unit cover	1
8	Actuator output flange	1	19	Aerial connectors with limit and torque switches	1
9	Motion measuring shaft subassembly	1	20	Electric cover	1
10	Torque switching shaft subassembly	1	21	User terminals	1
11	Torque regulator subassembly	1	22	Centronik unit with MODBUS interface	1

18.2 Centronik unit

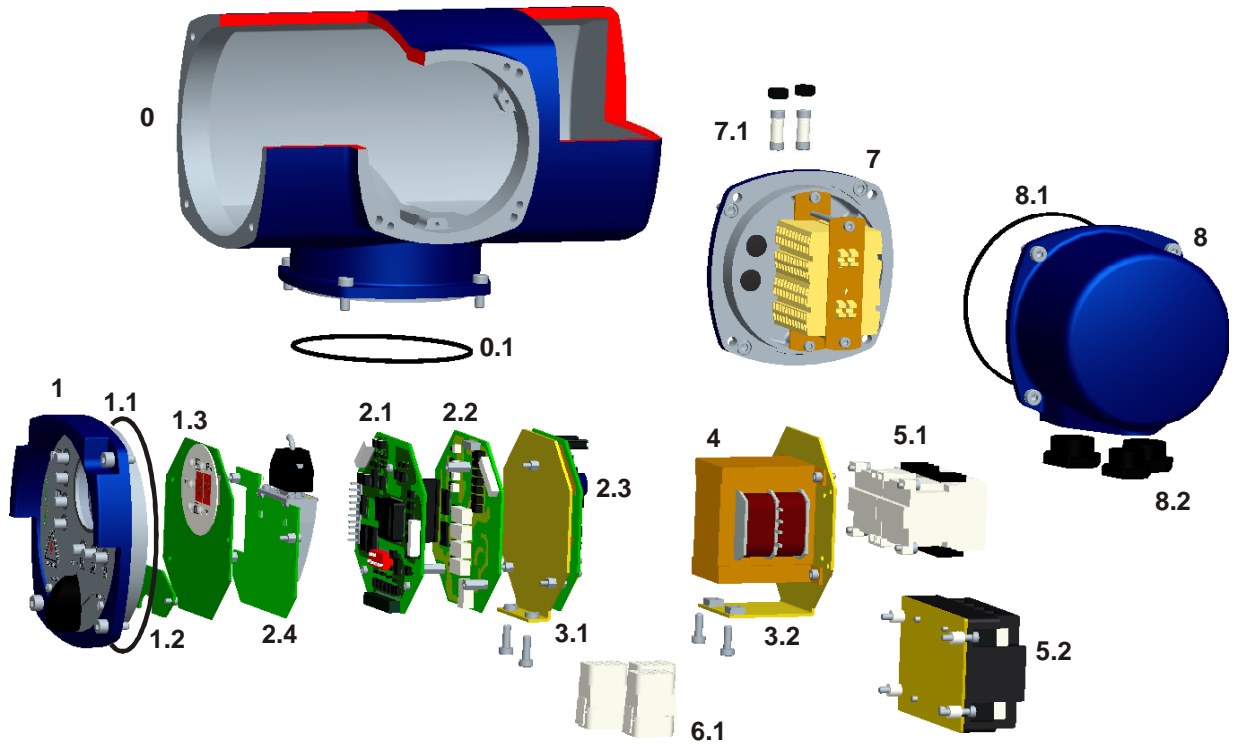

Mark	DESCRIPTION	Mark	DESCRIPTION
0	CENTRONIK MAIN CASE (ENCLOSURE)	4	TRANSFORMER
0.1	O-RING	5.1	CONTACTOR (STARTER)
1	CENTRONIK FRONTAL PANEL (ATEX VERSION)	5.2	SOLID STATE MOTOR STARTER: TYRISTOR (OPTIONAL)
1.1	O-RING	6.1	INTERNAL CONNECTION (AERIAL)
1.2	ELECTRONIC BOARD (KEYBOARD AND DISPLAY)	7	USER CONNECTION (TERMINALS)
2.1	ELECTRONIC BOARD (CPU)	7.1	FUSES
2.2	ELECTRONIC BOARD (I/O)	8	ELECTRIC COVER
2.3	ELECTRONIC BOARD (POWER)	8.1	O-RING
2.4	FIELDBUS ELECTRONIC BOARD	8.2	CABLE ENTRIES PROTECTION PLUGS
3.1	ELECTRONIC SUPPORT		
3.2	TRANSF. AND CONTACTOR SUPPORT		

APPENDIX: OUTPUT TYPES

OUTPUT TYPE A Size F-07 (ISO 5210)

Disassembly:

- Employing a suitable tool, remove the retaining ring (3), which fixes the removable bronze bush (1).
- Push in order to extract this piece.

Assembly:

- Having machined the removable bush according to valve stem dimensions, refit the drive bus (1) into the output shaft bore, align the keyway (2) in its output shaft shape.
- Refit the retaining ring (3).

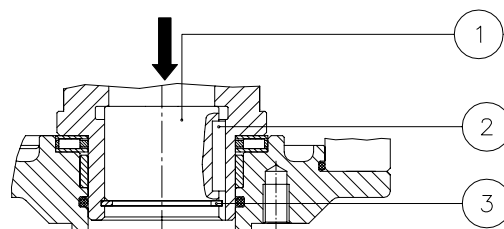

Figure 1

OUTPUT TYPE A Size F-10/F-16/F-25 (ISO 5210)

Disassembly:

- Push and press the removable bronze bush (2) in order to extract the cover (4), axial bearings (3) and removable bronze bush (2)

Assembly:

- Having machined the removable bronze bush according to valve shaft, clean thoroughly this piece. Apply grease on axial bearings and discs (3). Assemble axial disc on removable bush (2), finally insert the cover (4). Check O-rings on cover.
- Apply grease on. Insert the removable bush on output type A base casting unit and output shaft, notice that dog coupling (Tooth) on bushing should match with actuator hollow output shaft (1). Verify O-ring (4).
- For maintenance, grease can be supply thought grease nipple (5).

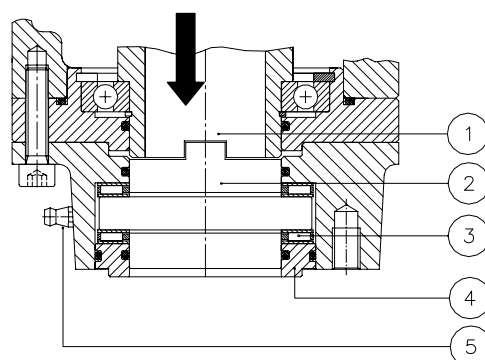

Figure 2

OUTPUT TYPE A Size F-14 (ISO 5210)

Disassembly:

- Remove retaining ring (5) and unscrew the stop ring (4) employing a suitable tool.
- Push and press the removable bronze bush (1) in order to extract it.

Assembly:

- Having machined the removable bush according to valve stem dimensions, refit the drive bus (1) into the output shaft bore (3), align the keyway (2) in its output shaft shape.
- Screw the stop ring (4) employing a suitable tool.
- Refit the retaining ring (5).

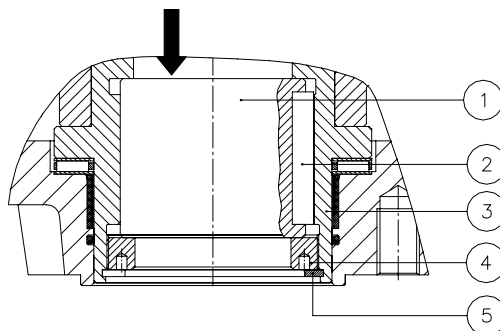

Figure 3

**OUTPUT TYPE B3 Size F-07/F-10/F-14/F-16/F-25
(ISO 5210)**

Disassembly:

- Employing a suitable tool, remove the retaining ring (4), which fixes the removable steel bush (1).
- Push in order to extract this piece.

Assembly:

- Having machined the removable steel bush according to valve stem dimensions, refit the drive bus (1) into the output shaft bore, align the keyway (2) in its output shaft shape.
- Refit the retaining ring (4).

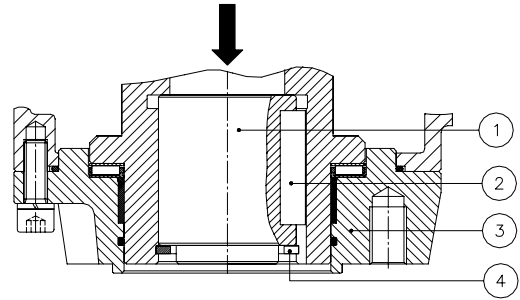

Figure 4

OUTPUT TYPE B0 Size F-10 / F-14

B0 output type is supplied, already machined, according to dimensions published in technical datasheets.

Disassembly:

- Employing a suitable tool, remove the retaining ring (3), which fixes the removable steel bush (1). Removable bush is located inside of output shaft (2).
- Push in order to extract this piece.

Assembly:

- Having machined the removable steel bush according to valve stem dimensions, refit the drive bus (1) into the output shaft bore.
- Refit the retaining ring (3).

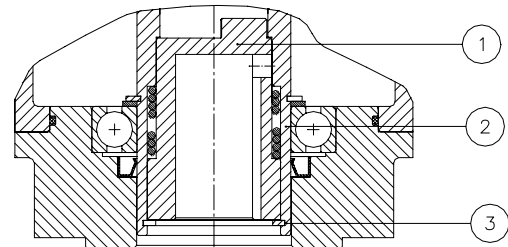



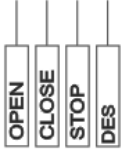

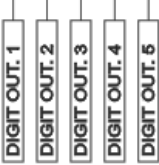
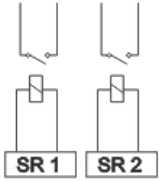

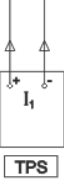

Figure 5

FASTEN BOLTS (CLASS 8.8)

BOLT	FRICTION FACTOR		
	LOW	MEDIUM	HIGH
M4	4.2	6	8
M6	6.2	8.2	10
M8	15	21	24
M10	30	41	48
M12	49	68	85
M14	85	108	130
M16	130	165	200
M18	170	240	280
M20	240	340	410
M30	800	1150	1350
M36	1450	2050	2400

Torque values in N.m
Steel bolts class 8.8

WIRING DIAGRAMS, TERMINAL PLANS, LEGENDS AND SYMBOLS

SYMBOL	DESCRIPTION	TECHNICAL FEATURES
	<p><u>M1</u> Main power supply (single and three-phase)</p>	<p>Main power supply: See Centronik nameplates Main voltage supply tolerance: $\pm 10\%$ Frequency tolerance: $\pm 5\%$</p>
	<p><u>M1</u> Main power supply (DC)</p>	<p>Main power supply: See Centronik nameplates Main voltage supply tolerance: $\pm 20\%$</p>
	<p><u>Remote inputs</u> OPEN, CLOSE, STOP (ALARM RESET), UNLOCK remote input signal</p>	
	<p><u>ESD</u> Emergency Shut Down remote input signal</p>	
	<p><u>Digital outputs</u></p>	<p>Programmable digital outputs 24VDC, 100mA max.</p>
	<p><u>SR1, SR2....SR5</u> Relay outputs</p>	<p>Programmable relay outputs SR1 to SR4: 250VAC/24VDC, 5A max. SR5: 250VAC/24VDC, 2A max.</p>
	<p><u>POSIT./COMUN</u> Control input</p>	<p>Analogue input 0/4-20mA or 0/5V (0/10V as option) Resistance value: 220Ω</p>
	<p><u>TPS</u> 0/4-20mA position transmitter</p>	<p>2 wires: 0/4-20mA Maximum resistance: 600 Ohms Precision: <1%</p>
	<p><u>POT</u> Precision Potentiometer</p>	<p>10 kOhms (other values on request) Ohmic value tolerance: $\pm 20\%$ std. ($\pm 10\%$ optional) Linearity: <1% Power: 1W max. Turning angle: $340^\circ \pm 5\%$ Life: 10^6 cycles</p>

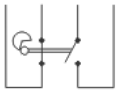
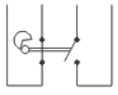
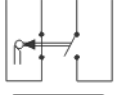
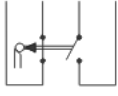
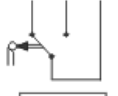
 <p>FPC 2</p>	<p>FPC CLOSE torque microswitch</p>	<p>Microswitch with silver contacts Type of contact: 1 NO / 1 NC Protection degree: IP67 Contacts: Two fast acting Mech. life: $5 \cdot 10^6$ Electr. life: $5 \cdot 10^6$ Microswitch circuits NO+NC contacts, only the same potential can be connected through both circuits. For different potentials, two double Microswitches must be used</p> <table border="1" data-bbox="710 548 1276 667"> <tr> <td rowspan="2">Silver contacts</td> <td colspan="3">AC</td> <td colspan="3">DC</td> </tr> <tr> <td>30V</td> <td>125V</td> <td>250V</td> <td>30V</td> <td>125V</td> <td>250V</td> </tr> <tr> <td>Max. load</td> <td>8A</td> <td>6A</td> <td>5A</td> <td>2A</td> <td>0.6A</td> <td>0.4A</td> </tr> </table>	Silver contacts	AC			DC			30V	125V	250V	30V	125V	250V	Max. load	8A	6A	5A	2A	0.6A	0.4A
Silver contacts	AC			DC																		
	30V		125V	250V	30V	125V	250V															
Max. load	8A		6A	5A	2A	0.6A	0.4A															
 <p>FPA 2</p>	<p>FPA OPEN torque microswitch</p>																					
 <p>FRC 2</p>	<p>FRC CLOSE limit microswitch. (CLOSE end position)</p>																					
 <p>FRA 2</p>	<p>FRA OPEN limit microswitch. (OPEN end position)</p>																					
 <p>AUX 1</p>	<p>AUX1 Auxiliary switches for middle-valve positions</p>	<p>Microswitch with silver contacts Type of contact: 1 NO (SPDT) Protection degree: IP67 Contacts: One fast acting Mech. life: $3 \cdot 10^7$ Electr. life: $3 \cdot 10^7$</p> <table border="1" data-bbox="710 963 1276 1075"> <tr> <td rowspan="2">Silver contacts</td> <td colspan="3">AC</td> <td colspan="3">DC</td> </tr> <tr> <td>30V</td> <td>125V</td> <td>250V</td> <td>30V</td> <td>125V</td> <td>250V</td> </tr> <tr> <td>Max.load</td> <td>4A</td> <td>4A</td> <td>4A</td> <td>2A</td> <td>0.6A</td> <td>0.4A</td> </tr> </table>	Silver contacts	AC			DC			30V	125V	250V	30V	125V	250V	Max.load	4A	4A	4A	2A	0.6A	0.4A
Silver contacts	AC			DC																		
	30V	125V	250V	30V	125V	250V																
Max.load	4A	4A	4A	2A	0.6A	0.4A																

For further technical information, consult CENTORK technical datasheet or contact directly with CENTORK. CENTORK address can be found printed on manual covers.

Others wiring diagrams are available and are included with each actuator provided.



DECLARATION OF CONFORMITY

CENTORK VALVE CONTROL S.L. hereby declares under sole responsibility that the electric actuators, series listed below

**140A. 140B. 140C. 140D. 140E. 140F. 146G. 146H.
141A. 141B. 141C. 141D. 141E. 141F. 141G. 141H.**

are designed and produced to be installed on industrial valves in hazardous zone and in compliance with the essential safety requirements of the ATEX directive 94/9/EC Annexe II and

94/9/EC directive: Equipment and protective systems intended for use in potentially explosive atmospheres.

89/336/EC Directive: Electromagnetic compatibility

73/23/EC directive: Low-voltage equipment

98/37/EC directive. Mechanical equipment-Machinery.

Compliance with the Essential health and Safety Requirements has been assured by compliance with,

ISO 5210: 1.991

ISO 5211: 2.001

EN 292-1: 1.993

EN 292-2: 1.993

EN 50081-2:1994

EN 50082-2:1998

EN 61000-4:1999

EN50014: 2000

EN50018: 1995

EN 50019: 1996

EN50020: 1996

EN 60204-1: 1.999

EN60034-1: 1.998

EN50178: 1.998

DIN VDE 0100: 1.997

DIN VDE 0530: 1982

The models has EC-type examination certificate LOM03ATEX2126X, and the marking of the equipment:

 II 2G EEx II de IIC T4..T5

Actuators has been manufactured in CENTORK VALVE CONTROL S.L, . Pol. Ind. 110 Txatxamendi 24-26 LEZO 20.100 –SPAIN-, certified by the *Laboratorio Oficial J. M. Madariaga* notified body LOM N°163,who authorized to mark the equipment as follow:

 **CE 0163**

San Sebastián, 21 de Enero de 2.008



Francisco Lazcano
-General manager-

(Centro fabricación y sede social)
Centork Valve Control S.L.
Pol ind. 110 Txatxamendi 24-26
Lezo 20.100 SPAIN



LABORATORIO OFICIAL J. M. MADARIAGA

(A1) **SCHEDULE**

(A2) EC-Type Examination Certificate: **LOM 03ATEX2126 X**

(A3) Description of equipment or protective system

Electrical actuators for valves composed by a flameproof electrical motor, gear box, control and signalling devices, increased safe connection box that include, optionally, intrinsic safe terminals; the last ones are marked and segregated from power terminals.

Electrical motor is protected with switch-off thermo-devices having two ranges: 120 °C and 140 °C that correspond to T4 or T5 temperature classes, respectively.

Control and signalling devices include flameproof type of protection micro-switches with certificate LCIE 02ATEX0034U.

Optionally are included intrinsic safe devices for position measurement in two versions

- a) Potentiometer, with three wire connection
Parameters: Pi: 804 mW para T4
Pi: 314 mW para T5
- b) 4-20 mA transmitter with certificate LCIE 02ATEX6073 X, with 2 wire external connection and internal connection to potentiometer
Parameters: same as indicated in certificate LCIE 02ATEX6073 X for the external connection

Different versions can have A.C. triphase electrical motors and also monophasic motors as follows:

Thriphase motors

- Power (kW): 0,022 - 0,045 - 0,09 - 0,18 - 0,37 - 0,55 - 0,75 - 1,1 - 1,5 - 2,2 - 3
- Voltage at 50 Hz (V): 230 - 380/415 - 500
- Voltage at 60 Hz (V): 230 - 440/460

Monophase motors

- Power (kW): 0,022 - 0,045 - 0,09 - 0,18 - 0,37 - 0,55
- Voltage at 50 Hz (V): 220/240
- Voltage at 60 Hz (V): 110/120

Type nomenclature

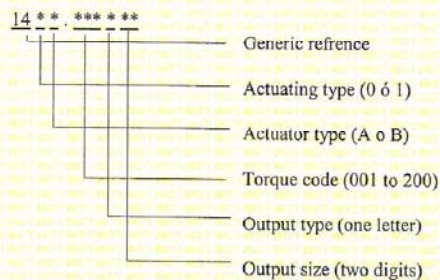

(This document may only be reproduced in its entirety)

This Certificate is a translation from the original in Spanish. The LOM liability applies only on the Spanish text



LABORATORIO OFICIAL J. M. MADARIAGA

(A1) **SCHEDULE**

(A2) EC-Type Examination Certificate: **LOM 03ATEX2126 X**

(A4) Tets report nr. **LOM 03.372 SP**

(A5) Special conditions for a safe use

- Electrical motor must be protected by means pf the appropriated circuit connected to protection thermal devices

(A6) Individual tests

Each manufactured motor must be submitted to pressure tests at 930 kPa according the paragraph 15.1.3 of the standard EN 50018:2000

(A7) Essential Health and Safety Requirements

Explosion safe requirements are covered by application of the standards indicated in page 1/3 of this certificate.

(A8) Descriptive documents

		Rev.	Date
- Description		-	2003-05-20
- Drawings nr.	00034XA	A	2000-04-18
	00035XA	A	2000-04-19
	00036XA	A	2000-04-19
	00037XX	-	2000-04-25
	00038XX	-	2000-04-25
	00056XA	A	2001-01-30
	00130XX	-	2002-01-09
	60974XA	A	2003-07-15



(This document may only be reproduced in its entirety)

This Certificate is a translation from the original in Spanish. The LOM liability applies only on the Spanish text Page 3/3



LABORATORIO OFICIAL J. M. MADARIAGA



(1) **EC-TYPE EXAMINATION CERTIFICATE SUPPLEMENT**

- (2) Equipment or protective system intended for use in potentially explosive atmospheres
Directive 94/9/EC
- (3) Supplement nr. 1 to EC-Type Examination Certificate number: **LOM 03ATEX2126 X**
- (4) Equipment or Protection System Electrical actuators
Type CENTORK 14**.*****
- (5) Applicant: Centork Valve Control, S.L.
- (6) Address: Cl. Portuetxe, 23
20018-SAN SEBASTIÁN
SPAIN
- (7) Test report nr. **LOM 03.524 OP**

(8) Variations included in this certificate

To include alternatively two new variants:

- Variant 1: Basic electric control actuators, actuators types C, D, E and F
- Variant 2: Electronic control actuators named CENTRONIK, actuators types G and H

Both variants have got a flameproof enclosure to contain the electric and electronic control devices but keeping motor types and increased safety connection box. The flameproof enclosure also includes a glass inspection window and push buttons with magnetic operation.

Type nomenclature

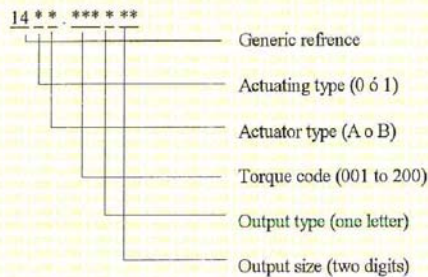

(9) Marking variations

For this variants. Temperature class according base certificate indications

II 2 G EEx de IIC T4..T5



This supplement must be an inseparable part together base certificate **LOM 04ATEX2056**
(This document may only be reproduced in its entirety and without any change)
This Certificate is a translation from the original in Spanish. The LOM liability applies only on the Spanish text



UNIVERSIDAD POLITÉCNICA DE MADRID
ENSAYOS E INVESTIGACIONES DE MATERIALES Y EQUIPOS PARA ATMÓSFERAS EXPLOSIVAS Y MINERÍA
(Real Decreto 334/1992 de 3 de Abril - BOE 1992-04-29 -)





LABORATORIO OFICIAL J. M. MADARIAGA

(3) Supplement nr. 1 to EC-Type Examination Certificate number: **LOM 03ATEX2126 X**

(10) Variation in the special conditions for a safe use
None

(11) Descriptive documents

	Rev.	Date
- Description	3.0	2004-10-22
- Drawings nr.:	A	2001-01-30
	-	2000-07-11
	-	2000-07-11
	A	2001-10-22
	-	2001-10-22
	A	2003-01-22
	-	2004-10-15
	-	2004-10-15
	A	2003-07-15

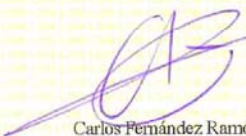

Carlos Fernández Ramón
DIRECTOR OF THE LABORATORY



Madrid, 22 Decembre 2004



Angel Vega Remesal
Head of TEX area

This supplement must be an inseparable part together base certificate **LOM 04ATEX2056**
(This document may only be reproduced in its entirety and without any change)
This Certificate is a translation from the original in Spanish. The LOM liability applies only on the Spanish text

PROFIBUS CERTIFICATE



Certificate

PROFIBUS Nutzerorganisation e.V. grants to

HMS Industrial Networks AB
Stationsgatan 37; 30245 Halmstad, Sweden

the Certificate No.: **Z01103** for the PROFIBUS Slave:

Product Name: Anybus-CC PROFIBUS DP-V1
Revision: 2.08; SW/FW: Version 2.06; HW: Version 2.03
GSD: HMS_1811.gsd; File Version: 2007/08/10

This certificate confirms that the product has successfully passed the certification tests with the following scope:

<input checked="" type="checkbox"/>	DP-V0	MS0, Sync, Freeze, Fail_Safe, Set_Slave_Add
<input checked="" type="checkbox"/>	DP-V1	MS1, MS2, I&M
<input type="checkbox"/>	DP-V2	
<input type="checkbox"/>	Profile	
<input checked="" type="checkbox"/>	Physical Layer	RS485

Test Report Number: **488-1**
 Authorized Test Laboratory: **Siemens AG, Fürth, Germany**
 Expiry date of Certificate: **October 16, 2010**

The tests were executed in accordance with the following documents:
 "Test Specification for PROFIBUS DP Slaves, Version 3.0 from November 2005".
 This certificate is granted according to the document "Framework for testing and certification of PROFIBUS products".

Karlsruhe, November 16, 2007



 (Official in Charge)



Board of PROFIBUS Nutzerorganisation e. V.

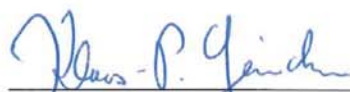

 (K.-P. Lindner)



 (Prof. K. Bender)

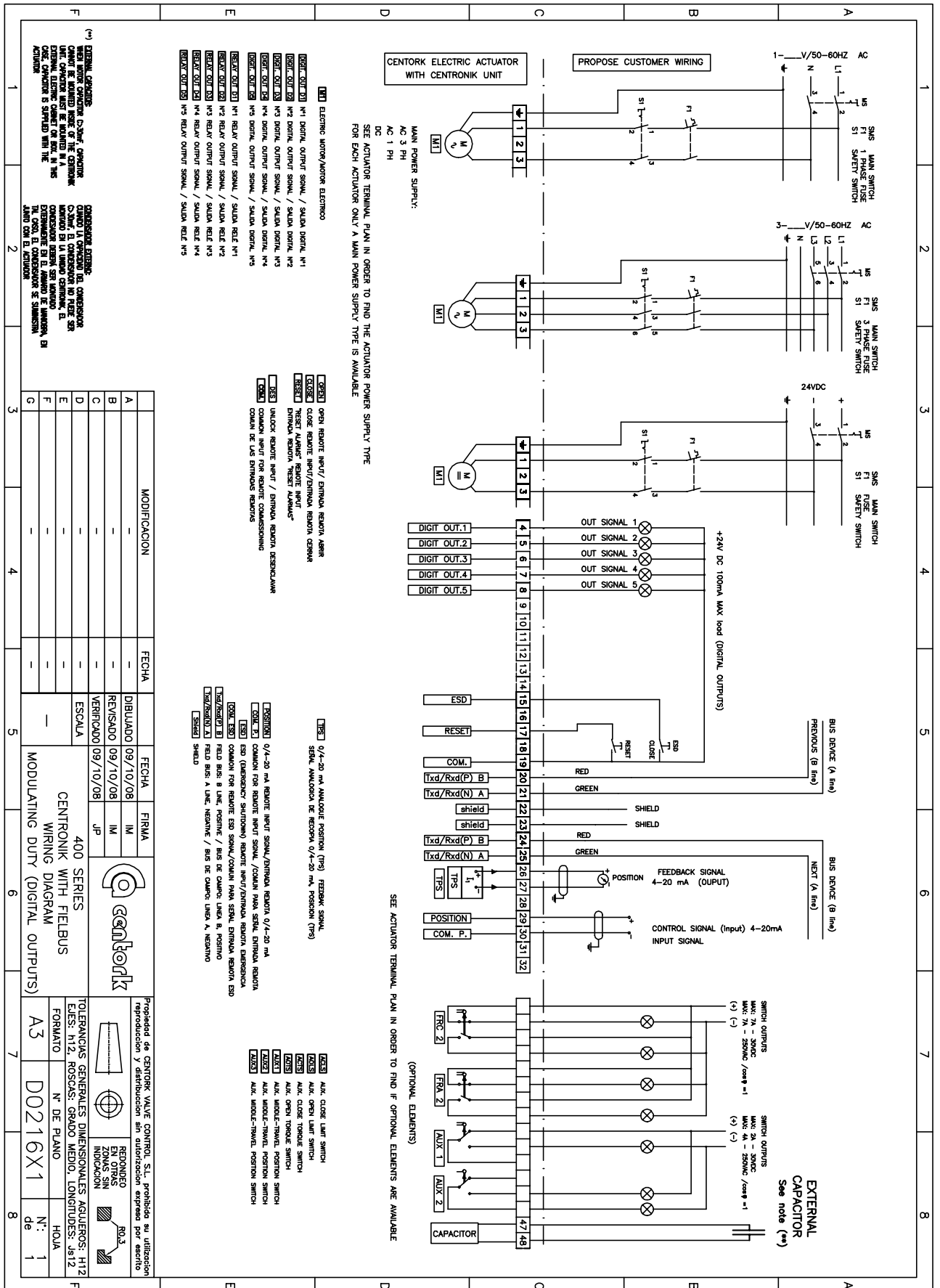

EXTERNAL CONNECTIONS
WHEN MOTOR OPERATOR IS USED, OPERATOR UNIT MUST BE INSTALLED IN THE CENTRONIK UNIT. THE CENTRONIK UNIT MUST BE INSTALLED IN THE CENTRONIK UNIT. THE CENTRONIK UNIT MUST BE INSTALLED IN THE CENTRONIK UNIT. THE CENTRONIK UNIT MUST BE INSTALLED IN THE CENTRONIK UNIT.

MODIFICACION	FECHA	FECHA	FIRMA
A	-	09/10/08	IM
B	-	09/10/08	IM
C	-	09/10/08	JP
D	-	09/10/08	JP
E	-	-	-
F	-	-	-
G	-	-	-

MODIFICACION	FECHA	FECHA	FIRMA
A	-	09/10/08	IM
B	-	09/10/08	IM
C	-	09/10/08	JP
D	-	09/10/08	JP
E	-	-	-
F	-	-	-
G	-	-	-

400 SERIES CENTRONIK WITH FIELD BUS WIRING DIAGRAM (DIGITAL OUTPUTS)

Propiedad de CENTORK VALVE CONTROL, S.L. prohibida su utilización reproducción y distribución sin autorización expresa por escrito

RECORDED EN OTRAS INSTRUCCIONES

TOLERANCIAS GENERALES DIMENSIONALES AGUJEROS: H12
EJES: h12, ROSCAS: GRADO MEDIO, LONGITUDES: JS172
FORMATO N° DE PLANO HOJA
A3 D0216X1 N°: 1 de 1



CENTORK Valve Control S.L.

Pol. Ind. 110 , Txatxamendi 24-26
Telf.: +34.943.31.61.36
Email: actuator@centork.com

LEZO 20.100 (SPAIN)
Fax:: +34.943.22.36.57
<http://www.centork.com>

1497.MANEPROF140CX001

Edition: 12.09