



# Centork electric actuators 402 to 404 and 412 to 414 series



*Installation and maintenance  
User manual*



**THIS USER MANUAL HAS BEEN DEVELOPED FOR centork ELECTRIC ACTUATORS 402, 412, 403, 413, 404 AND 414 SERIES WITH CENTRONIK UNIT**



## CAUTION

**centork** Electric actuators are high value devices. In order to prevent damage in their handling, setting and use it is essential to follow and observe all the points in this user manual, operate under actuators' designated use, and observe health and safety rules, standards and directives, as other national regulations as well.

**centork** Electric actuators must be handled with care and caution.

### IMPORTANT NOTE

This work and the information it contains are property of CENTORK Valve Control S.L.. The information it contains will not be reproduced or disclosed, in whole or in part, without the prior written consent of CENTORK.

The content in this manual is subject to change due to the quality improvement without individual notice.



## Index

1	CENTORK ELECTRIC ACTUATORS: INTRODUCTION .....	7
2	SAFETY INSTRUCTIONS.....	7
3	TRANSPORT AND STORAGE .....	8
3.1	Transport.....	8
3.2	Storage and commissioning.....	8
3.2.1	Commissioning .....	8
3.2.2	Storage .....	9
4	CONDITIONS OF SERVICE FOR ELECTRIC ACTUATORS .....	10
4.1	Electric actuator: Main description and purpose.....	10
4.2	Operation modes: OFF, LOCAL and REMOTE mode.....	10
4.2.1	OFF mode.....	10
4.2.2	LOCAL mode.....	10
4.2.3	REMOTE mode.....	11
4.2.4	Program mode .....	11
4.3	Actuator and motor duty service .....	12
4.4	Temperature range .....	12
4.5	IP protection degree.....	12
4.6	Painting and protection against corrosion.....	12
4.7	Centronik types: Identification.....	13
5	MOUNTING TO THE VALVE .....	14
5.1	Pre-Installation Inspection.....	14
5.2	Output size .....	14
5.3	Output type.....	14
5.4	Mounting.....	14
5.5	Frontal panel orientation .....	15
6	ELECTRICAL CONNECTIONS .....	16
6.1	Wiring diagram (electric manoeuvre).....	16
6.1.1	Duty service .....	16
6.1.1.1	ON/OFF duty.....	16
6.1.1.2	Modulating duty.....	16
6.1.1.3	ON/OFF duty with position.....	16
6.1.2	Components.....	17
6.1.2.1	Voltage supply.....	17
6.1.2.2	Digital outputs .....	17
6.1.2.3	Relay outputs .....	17
6.1.2.4	Position transmitter .....	18
6.1.2.5	Capacitors .....	18
6.1.2.6	Field bus.....	18
6.1.2.7	Other elements.....	18
6.2	Terminal plan and wiring.....	19
6.3	Cable installation in accordance with EMC.....	20
6.4	Centronik unit on wall bracket (as option).....	20
7	MANUAL OPERATION.....	21

8	LOCAL MODE: CONTROL AND DISPLAYS ELEMENTS .....	22
8.1	Lockable selector.....	22
8.2	Push-buttons .....	23
8.3	LED indications.....	23
9	SWITCHING AND SIGNALING UNIT .....	24
10	SETTINGS AND PRELIMINARY TESTS (START-UP).....	25
10.1	DIP-SWITCHES configuration.....	26
10.1.1	Operation mode .....	26
10.1.2	Centronik output signals configuration (Only in ON/OFF duty) .....	26
10.1.3	Actuator and valve (Sense of rotation) .....	27
10.1.4	Posicion transmitter range (only in Modulating duty and ON/OFF duty with position display) 27	
10.1.5	Remote mode selection .....	27
10.2	Closed position limit switch setting .....	28
10.3	Open position limit switch setting .....	29
10.4	Torque switching setting.....	29
10.5	Mechanical position indicator setting (optional) .....	30
10.6	Auxiliary limit switches setting (optional).....	30
10.7	Potentiometer POT setting (optional).....	31
10.8	0/4-20mA transmitter TPS setting (optional) .....	31
10.9	CENTRONIK setting procedure (only Modulating and On-Off with display units) .....	32
10.9.1	Access to program mode – Password.....	33
10.9.2	Control input signal (only in Modulating duty).....	33
10.9.3	Polarity (only in Modulating duty) .....	34
10.9.4	Zero and span for Control input and TPS –feedback signal- (only in Modulating duty) .....	34
10.9.5	Outputs signals (Digital or relays outputs).....	36
10.9.6	Rest time.....	36
10.9.7	Valve opening curves (only in Modulating duty).....	37
10.9.8	Operation mode ESD (only in Modulating duty and ON/OFF duty with position display) .....	38
10.9.9	Deadband (only in Modulating duty).....	38
10.9.10	Autolearn (only in Modulating duty).....	39
10.9.11	Close tightly (only in Modulating duty).....	39
10.9.12	Blinker (only in Modulating duty and ON/OFF duty with position display).....	40
10.9.13	Calibration of the CENTRONIK unit .....	40
10.9.14	Inching mode (only in ON/OFF duty and ON/OFF duty with position display) .....	40
10.9.15	Stepping mode (only in ON/OFF duty with position display).....	41
10.9.16	Data logging.....	43
10.9.17	New Password.....	43
11	TROUBLE SHOOTING .....	44
11.1	Front panel indication fault .....	44
11.2	Actuator does not operate in LOCAL mode .....	45
11.3	Actuator does not operate correctly in REMOTE mode .....	45
11.4	Actuator turn in the wrong sense.....	45
11.5	Centronik output signals does not work .....	45
12	MAINTENANCE .....	46
12.1	Commissioning, after the star-up .....	46
12.2	Maintenance for service .....	46

---

12.3	Electric actuator's service life.....	46
12.4	Fuse replacement .....	47
13	TECHNICAL SUPPORT .....	48
14	LIST OF SPARE PARTS .....	49
14.1	Actuator unit .....	49
14.2	Centronik unit .....	50
	APPENDIX: OUTPUT TYPES.....	51





## 1 CENTORK ELECTRIC ACTUATORS: INTRODUCTION

The electric actuator is a device designed to be coupled to a general purpose industrial valve, to carry out its movement. The movement is stopped by limit switching or by torque (thrust) switching.

Other applications should be consulted CENTORK before. CENTORK is not liable for any possible damages resulting from use in other than designated applications. Such risk lies entirely on the user.

## 2 SAFETY INSTRUCTIONS

The scope of this manual is to enable a competent user to install, operate, adjust and inspect a CENTORK electric actuator. These instructions must be observed, otherwise a safe operation of the actuator is no longer warrantee.

**When handling electric equipment, the health and safety standards (EN 60.204, 73/23/EEC directives) and any other national legislation applicable must be observed.**



As electric device, during electrical operation certain parts inevitably carry lethal voltages and currents (ELECTRICAL RISKS).

Works on the electrical system or equipment must only be carried out by a skilled electrician himself or by specially instructed personnel, in accordance with the applicable electrical engineering rules, health and safety Directives and any other national legislation applicable.

Electric actuators are powerful apparatus. A negligence handling might cause severe damages to valves, people, and actuator as well. Under no circumstances should any modification or alteration be carried out on the actuator as this could very well invalidate the conditions which the device was designed.



Under operation, motor enclosure surfaces can reach high temperatures (up to 100°C). Protection measures should be taken into account in order to prevent people and goods from it.



### 3 TRANSPORT AND STORAGE

#### 3.1 Transport



- **CENTORK electric actuators must be transported in sturdy packing.** During transport measures should be adopted in order to prevent impacts, hits. CENTORK delivers its actuators ex-work.
- **For transport purposes, handwheels are supplied separately.**
- **Hits or impacts against wall, surfaces or objects might cause severe damage on Electric actuator.** In these cases, after such events, a technical inspection must be done by CENTORK technicians.
- **Do not attach to the handwheel ropes or hooks to lift by hoist.**
- The valve-actuator unit cannot be lifted/manipulated employing any lifting point of the actuator; Actuator has been designed and sized in order to motorize industrial valves, and withstand the forces and torque required.
- **Covers have to be properly closed (Tight) and sealed. Cable entries on electrical connection cover must be sealed. Protection plug supplied by CENTORK are only adequate for storing in dry and ventilated places, for short period of time. In other conditions protection plug must be replaced with metallic plug sealed with PTFE tape.**
- Each Actuator is delivered with a set of technical documentation (User manual, datasheet, diagrams...), which has to be carefully stored.

#### 3.2 Storage and commissioning

**Despite of their high degree of protection (IP67 as standard, and IP68 optional) condensation – presence of water- can occur inside the electric actuators by incorrect and negligent handling of the actuators. This may damage sensitive internal parts during the storage. This problem can be avoided by observing the following points.**

##### 3.2.1 Commissioning

- Verify the actuator to insure correct model number, torque, operating speed, options and special components, voltage and enclosure type, and the actuator control before installation or use. It is important to verify that the actuator is appropriate for the requirements of the valve and the intended application. If there is any discrepancy, please contact with your local distributor, or CENTORK, to solve that discrepancy. Once the electric actuator has been set up, CENTORK decline any responsibility related to discrepancies.
- Check (Visual inspection) in order to detect possible damages caused during transport or storage. **Checking should include a visual inspection of electric compartment, and switching and signalling unit compartment.**
- Check that the painting work of the actuator is not been damaged. Retouch it when damaged.
- Check that electrical connection cover, centronik frontal panel and switching and signalling unit cover and are correctly closed and tight. Cable entries on electrical connection cover must be sealed. Protection plug supplied by CENTORK are only adequate for storing in dry and ventilated places, for short period of time. In other conditions **protection plug must be replaced with metallic plug sealed with PTFE tape.**
- Each Actuator is delivered with a set of technical documentation (User manual, datasheet, diagrams...), which has to be carefully stored.
- If damages like shocks, cracks, hits or others due to an improper handling, or humidity inside the equipment due to improper storage appear, contact CENTORK or your nearest distributor.

### 3.2.2 Storage



- **Store in a clean, cool, dry and ventilated place. Protect against humidity from the floor. Use pallets, wooden frames, cage boxes or shelves.**

- Check that electrical connection cover and switching and signalling unit cover and are correctly closed and tight.



- Cable entries on electrical connection cover must be sealed. Protection plug supplied by CENTORK are only adequate for storing in dry and ventilated places, for short period of time. In other conditions **protection plug must be replaced with metallic plug sealed with PTFE tape.**



- Do not store the actuator directly on the ground!
- Cover it to protect it from dust and dirt. Cover the machined parts with suitable protection against corrosion. Do not employ plastic bags, as they can cause condensation.
- Each Actuator is delivered with a set of technical documentation (User manual, datasheet, diagrams...), which has to be carefully stored.
- **For other storage conditions or, and long time periods (More than 5 months) contact to manufacturer.**

## 4 CONDITIONS OF SERVICE FOR ELECTRIC ACTUATORS

### 4.1 Electric actuator: Main description and purpose

- Electric actuator is an apparatus or device formed by an electric motor, coupled to a main gearbox unit, which transmits motion and torque to valves.
- Power supply and controls elements (transformer, relays, leds, electronic boards...) are included in the Centronik unit. Centronik unit has CPU microprocessor and electronic boards: Electric actuator is operated and controlled by means of these electronic and electric device of the centronik unit, being supplied with main power.
- Electric actuator can be controlled in LOCAL mode by mean of pushbuttons located in the centronik front panel or in REMOTE mode with remote controls such us SCADA, PLC, or a MASTER STATION by mean of a FIELDBUS (Optional)
- Electric actuators are provided with a declutchable manual override system in order to operate manually in case of emergency or fail of power supply.
- Electric actuator can be coupled directly to valve, or maybe, through gearbox units (Bevel, spur and worm gearboxes).
- The electric actuator is a device designed to be coupled to a general purpose industrial valve, to carry out its movement. The movement is stopped by limit switching or by torque (thrust) switching. Other applications should be consulted CENTORK before. **CENTORK is not liable for any possible damages resulting from use in other than designated applications. Such risk lies entirely on the user.**

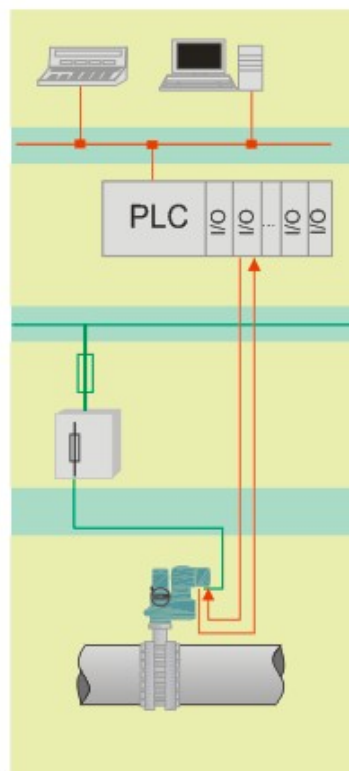

### 4.2 Operation modes: OFF, LOCAL and REMOTE mode

Electric actuator can be controlled by the control station (REMOTE mode) and at the local control (LOCAL mode). Centronik unit is equipped with local pushbuttons. The lockable selector switch LOCAL/OFF/REMOTE allows the operation mode to be set.

#### 4.2.1 OFF mode.

- In this operation mode, the actuator remains connected and powered but it does not responds to any order (Open, close or stop) from the front panel or from the remote control, but actuator will be online, from a FIELDBUS point of view. The front panel control indicates only the power supply status (led 5).

#### 4.2.2 LOCAL mode.

- By mean of push buttons OPEN-CLOSE-STOP located on the centronik front panel, the actuator can be operated locally. 5 indication lights (LEDs) show the actuator status from the centronik front panel (chapter 8.3).
- Push buttons are **self-retaining** type: Once the push button has been pressed, its order or action is generated, and it remains “active” until a new order or command is generated, or any operation event takes place such us a limit switch or torque switch signal, an anomaly case or any centronik function or event. It is NOT necessary to keep “pressing” the pushbutton.

#### 4.2.3 REMOTE mode.

##### Electric actuator with ON/OFF duty control:

- Electric actuator can be controlled by the control station (REMOTE) with the commands OPEN-CLOSE-STOP (**self-retaining**) or OPEN-CLOSE (“**push to run**” operation) as option.
- ON/OFF duty control means open loop control.
- With **self-retaining operation**, the actuator continues to run as long as the STOP command from the control system (digital input) is not being generated, or any centronik operation condition takes place.
- With “**push to run**” operation (Inching mode) the actuator continues to run as long as this command from the control system (digital input) remains. It is necessary to keep “pressing” the pushbutton or the remote input.
- TPS Electronic position transmitter (0-4/20mA, 0-2/10V or resistive value) can be employed, as option, which in order to provide the real valve position indication.

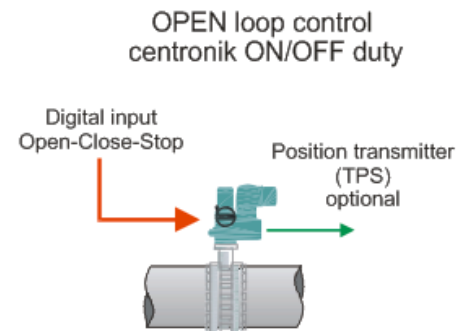

##### Electric actuator with modulating duty control:

- Electric actuator is equipped with an electronic integral positioner that automatically positions the valve in accordance with the analogue input control signal (0-4/20mA current signal and voltage signal as option)
- Modulating duty control means close loop control. The modulating duty registers and compares the analogue input control and the actual position value (Feedback signal given by actuator position transmitter). The electric actuator runs to OPEN or CLOSE direction, according to the deviation detected.
- The modulating behaviour is stabilised by determining inner (internal) and outer (external) deadbands, rest time and therefore the wear of valve and actuator can be reduced.

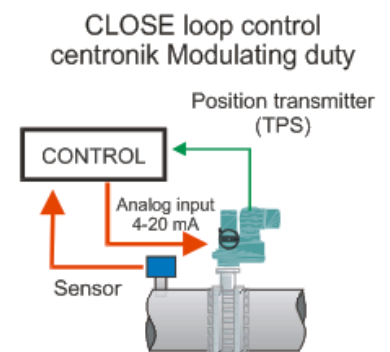

##### Electric actuator with ON/OFF duty control, with position display:

- This mode is has an ON/OFF duty control but with some advance and upgrade functions:
  - Some parameters can be configured via the centronik frontal panel.
  - Frontal panel has a continuous position display.
  - Some different operation modes can be programmed or set.

#### 4.2.4 Program mode

- For **on-off with display** and **modulating** duties centronik units, by mean of the program mode it is possible to select and configure the centronik parameters, functions and features (See 10.9 chapter)
- In order to access to this mode, it is necessary to switch the centronik selector in LOCAL mode and introduce the correct PASSWORD (See 10.9.1 chapter)

### 4.3 Actuator and motor duty service

Electric actuator has been designed for valve motorization, which requires ON-OFF or modulating duty service.

- **ON-OFF duty service:** Electric actuator has been designed as S2-15 min (Three phases motor) or S2-10 min (Single phases motors) duty cycle at nominal torque, according to IEC 60034 standards: Nominal torque is rated to 50% of max tripping torque (100%), value marked on actuator nameplates. Higher nominal torques can reduce the actuator's service life and S2 duty cycle.
- **Modulating duty service:** Electric actuators have been designed as S4-25% according to IEC 60034, at 1.200-800 starts per hour, at nominal torque. Nominal torque is rated to 50% of max tripping torque (100%), value marked on actuator nameplates. Higher nominal torques can reduce the actuator's service life and S4 duty cycle conditions.

### 4.4 Temperature range

CENTORK Electric actuators work in a temperature range from -25°C to +70°C.

For other temperature range, consult CENTORK.

### 4.5 IP protection degree

- CENTORK Electric actuators are designed in their standard version with IP67 (acc. EN 60.529) environmental protection although IP68 protection may be supplied on request.
- **IP67 and IP68 protection degree is only guarantee employing proper protection plug and cable gland (For cable entries)**, according to IP degree (Chapter 6.2).
- It is necessary to observe storing and maintenance rules written on TRANSPORT AND STORAGE as well (Chapter 3).

### 4.6 Painting and protection against corrosion

- CENTORK has designed three protections degree: Standard protection, P1 and P2. For technical details, consult CENTORK technical datasheets. Other processes are possible, under request.
- CENTORK standard protection: Electric actuators are coated with an epoxy- two components primer (Film thickness depends on protection class selected, actuators are coated with intermediates primers) followed by a polyurethane component paint coat. The standard colour is blue RAL 5.003. Other colours are possible (Option). Other film thickness under request.

#### 4.7 Centronik types: Identification

- The followings data are defined on the Centronik nameplates.
- As standard, there are 3 types of control of centronik unit:
  - **On-off** control centronik unit
  - **Modulating** control centronik unit
  - **ON-Off** with display control centronik unit.

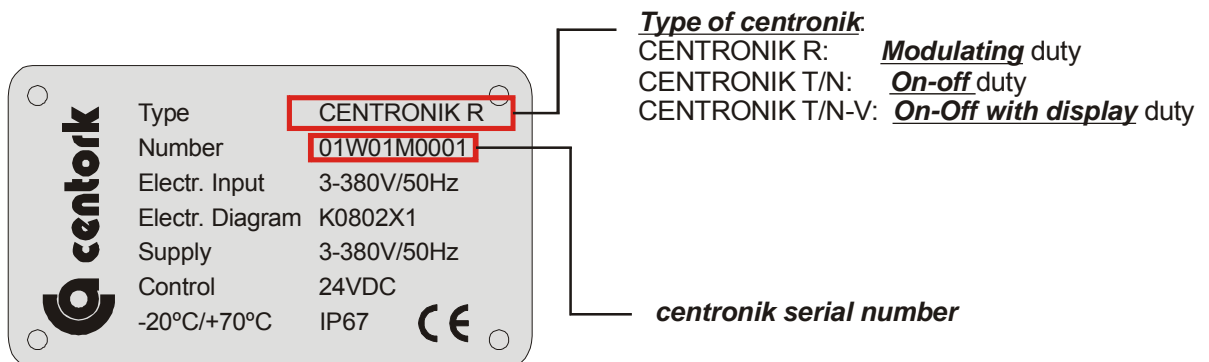

- The type of centronik (Control) is indicated and marked in the centronik nameplates, and it is described also in the CENTORK acknowledgment order. On the nameplate is also depicted other features as: Main power supply and terminal plan (Electric diagram)
- The centronik serial number must be the same as the actuator serial number (printed on actuator and motor nameplates), if the actuator has been supplied as a whole unit.
-  **The centronik serial number allows defining and identifying all actuator data. It will be required for any consult concerning to the electric actuator.**

## 5 MOUNTING TO THE VALVE

### 5.1 Pre-Installation Inspection

- Verify the actuators nameplate to insure correct model number, torque, operating speed, voltage and enclosure type before installation or use.
- It is important to verify that the output torque of the actuator is appropriate for the torque requirements of the valve and that the actuator duty cycle is appropriate of the intended application.

### 5.2 Output size

Check whether actuator output flange suits the flange of the valve to be driven. The latter should have been designed following the ISO5210 or ISO5211 standard, for standard application, or following the customer's specifications, for special application.

### 5.3 Output type

Check that the type of flange coupling of the actuator suits the valve to be driven (diameters and lengths). Those manufactured as Standard at CENTORK follow the ISO5210/5211 standards. Types of output drive:

- **Output type A:** If not otherwise specified in the order, it is supplied blank. The thread must be machined according to the stem of the valve to be driven. For the dismantling and machining of this type of output, see Appendix. Output type A models can withstand axial loads and torque
- **Output type B0, B1, B2, C:** It is supplied machined to the dimensions stated in the ISO 5210/5211 or DIN 3338 standard. For the dismantling and machining of this type of output, see Appendix. Output type B and C models **cannot withstand axial loads.**
- **Output type B3, B4:** It is supplied blank. Output type B models **cannot withstand axial loads.** For the dismantling and machining of this type of output, see Appendix.

### 5.4 Mounting

- Check size and the type of output match the valve to be driven.
- Degrease the mounting surfaces at actuator and valve thoroughly.
- Slightly grease the input shaft of the valve to be driven.
- Fit the actuator into the valve. In the event of a threaded output (type A), use the handwheel for turning the nut over the threaded stem.
- **Do not lift the actuator by the handwheel.**
- The actuator may be mounted in any position. Before mounting, check proper orientation actuator and valve in order to simplify access to handwheel, switching and terminal compartments (Maintenance and start-up tasks).
- The valve output shaft must be inline with the actuator output drive to avoid side-loading the shaft. To avoid any backlash no flexibility in the mounting bracket or mounting should be allowed.
- Using ISO Class 8.8 quality bolts, fasten crosswise controlling the applied torque according to the table in Appendix



## 5.5 Frontal panel orientation

Centronik frontal panel position can be changed.

- Remove/shut-off the centronik main power supply.
- Open the frontal panel: Unfasten/loose the 4 M6 metric bolts of the frontal panel.
- Place/Orientate the frontal panel in the desired position; Check that o-ring sealing is not damaged and the centronik white cable (See figure below) which connects the frontal electronic board to main CPU board is not trapped. **Notice the red wire in the lower part of the cable depicts the right connection** of the cable.

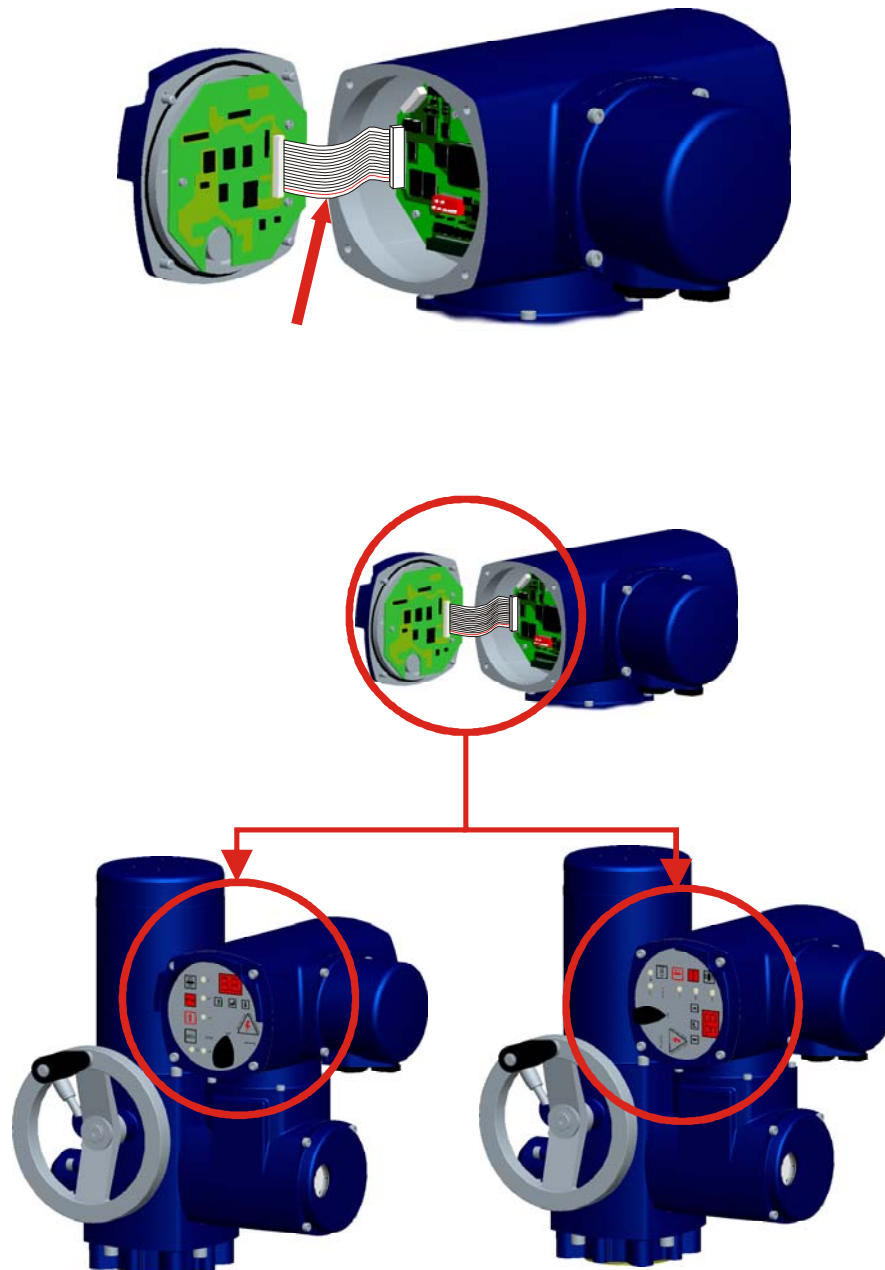

## 6 ELECTRICAL CONNECTIONS



**CAUTION:** Safety instructions on chapter 2 must be observed. Work on electrical system or equipment must only be carried out by skilled electrician.

### 6.1 Wiring diagram (electric manoeuvre)



Electric actuator datasheet, supplied with the actuator, includes a **PROPOSED WIRING DIAGRAM**, delivered with other technical documentation.

Features of electric and electronic components listed on appendix. Wiring diagram are included on appendix.

#### 6.1.1 Duty service

##### 6.1.1.1 ON/OFF duty

**Digital input for Remote control:**

- OPEN
- CLOSE
- STOP (ALARM RESET)
- DES (UNLOCK)

**Characteristics:** --.

**Setting:** --.

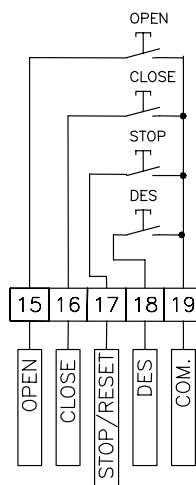

##### 6.1.1.2 Modulating duty

**Digital and analogue input for Remote control:**

- ESD (Emergency Shut Down)
- RESET (ALARM RESET)
- POSITION (Set position)

**Characteristics:** Analogue input 220Ω.

**Setting:** Chapters 10.9.13 and 10.9.8.

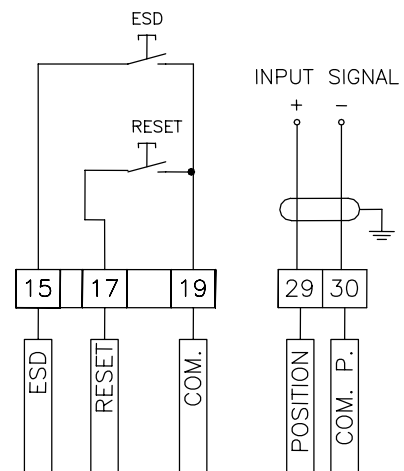

##### 6.1.1.3 ON/OFF duty with position

**Digital input for Remote control:**

- OPEN
- CLOSE
- STOP (ALARM RESET)
- DES (UNLOCK)
- ESD (Emergency Shut Down)

**Characteristics:** --.

**Setting:** Chapter 10.9.8.

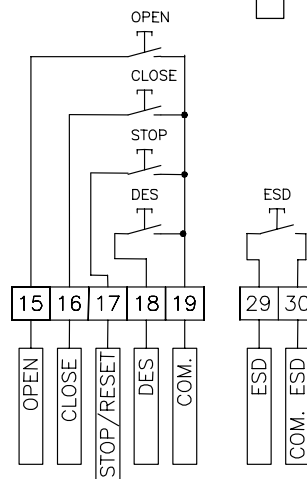

## 6.1.2 Components

### 6.1.2.1 Voltage supply

Voltage supply type available:

- 3 phases power supply: 220/240/380/400/420/440/460/500/600V ( $\pm 10\%$ ), 50/60Hz ( $\pm 5\%$ )
- 1 phase power supply: 110/220/240V ( $\pm 10\%$ ), 50/60Hz ( $\pm 5\%$ )
- DC power supply: 24VDC ( $\pm 20\%$ )



**Where UPS systems are required, the power supply should have negligible harmonic distortion. In general terms actuators are designed to operate on power supplies conforming to recognised power supply standards such as EN 50160 – Voltage Characteristics of Electricity Supplied by Public Distribution systems.**

### 6.1.2.2 Digital outputs

+24VDC 100 mA max load

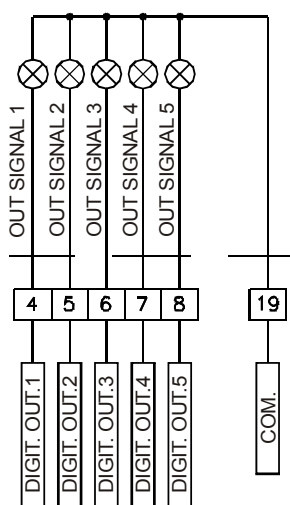

Digital outputs are programmable with the following functions:

- |                                  |                         |
|----------------------------------|-------------------------|
| ▪ Valve OPEN                     | ▪ Local selected        |
| ▪ Valve CLOSE                    | ▪ Remote selected       |
| ▪ Overtorque                     | ▪ Intermediate position |
| ▪ Overtorque reached in OPEN     | ▪ Position reached      |
| ▪ Overtorque reached in CLOSE    | ▪ Rest time             |
| ▪ Motor protection tripped       | ▪ ESD signal            |
| ▪ Lost phase                     |                         |
| ▪ Anomaly                        |                         |
| ▪ Command signal failure( < 4mA) |                         |

**Characteristics:** 24VDC, 100mA max.

**Setting:** Chapter 10.9.5.

### 6.1.2.3 Relay outputs

#### RELAY OUTPUTS

Max: 5A-30VDC

Max: 5A-250VAC /  $\cos\phi=1$

(+) (-)

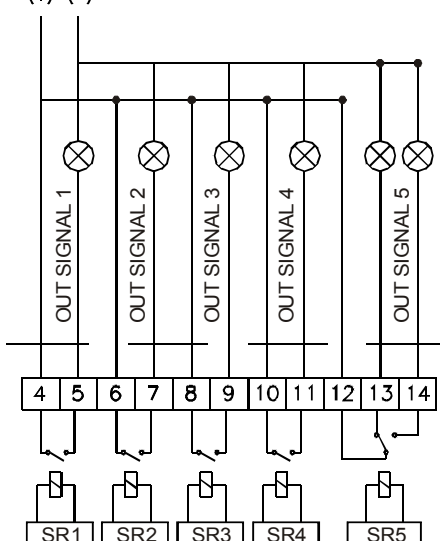

Digital outputs are programmable with the following functions:

- |                                  |                    |
|----------------------------------|--------------------|
| ▪ Valve OPEN                     | ▪ Position reached |
| ▪ Valve CLOSE                    | ▪ Rest time        |
| ▪ Overtorque                     | ▪ ESD signal       |
| ▪ Overtorque reached in OPEN     |                    |
| ▪ Overtorque reached in CLOSE    |                    |
| ▪ Motor protection tripped       |                    |
| ▪ Lost phase                     |                    |
| ▪ Anomaly                        |                    |
| ▪ Command signal failure( < 4mA) |                    |
| ▪ Local selected                 |                    |
| ▪ Intermediate position          |                    |

**Characteristics:**

- SR1 to SR4: 250VAC/24VDC, 5A max.
- SR5: 250VAC/24VDC, 2A max.

**Setting:** Chapter 10.9.5.

### 6.1.2.4 Position transmitter

FEEDBACK SIGNAL  
4-20 mA (OUTPUT)

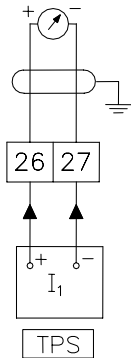

**TPS Transmitter gives a signal (Current or voltage) proportional to valve position.**

**Characteristics:**

- Output Signal (current): 2 wires (0/4-20mA), 600Ω Max.
- Optional - Output Signal (voltage): 2 wires (0/2-10V), 1200Ω Min.
- Precision: < 1%.

**Setting:** Chapters 10.1.4, 10.8 and 10.9.13.

### 6.1.2.5 Capacitors

**Capacitors** for single-phase A.C. motors are delivered with electric actuators. In case of external connection, when due to capacitor dimension it is not possible to mount it inside of the centronik unit (Capacitors  $C > 30 \mu\text{F}$ ), capacitors have to be installed on electric cabinet (External), as it is depicted on the actuator terminal plan. Each capacitor is dimensioned according to motor voltage and power. **The electrical actuators with single-phase motors, the capacitors will have to be installed in safety zone. If capacitor has to be in hazardous area, capcitor must be according to a valid way of protection for the zone of use (Hazardous areas)**

### 6.1.2.6 Field bus

Field bus is a optional feature. Contact CENTORK for additional information.

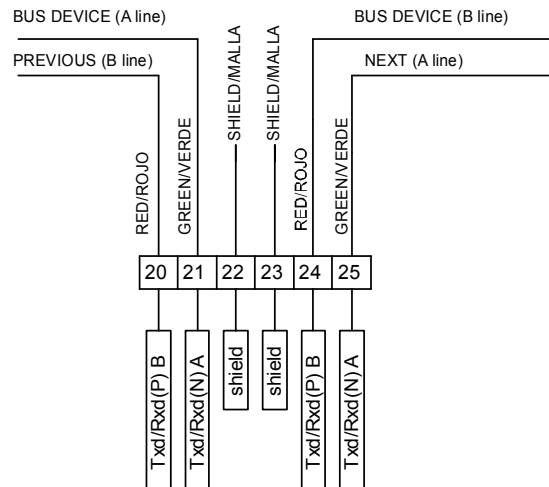

### 6.1.2.7 Other elements

Additional limit, auxiliary middle position or torque switches available (Optional elements). See Appendix.

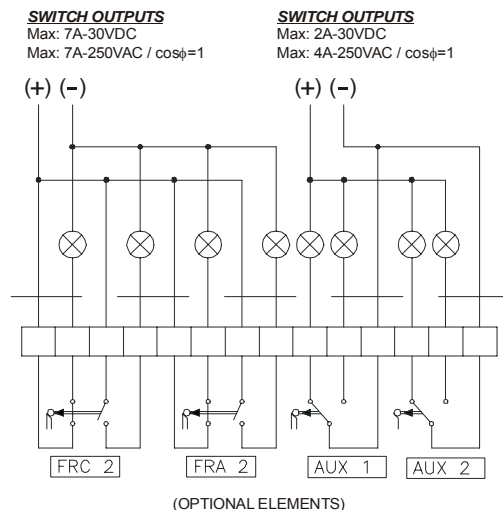



## 6.2 Terminal plan and wiring

The electric connection diagram or terminal plan is depicted on Electric actuator datasheet, supplied with the electric actuator, and it can be found printed on a label inside of electrical compartment cover.

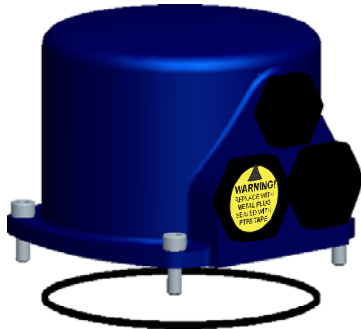
- Open the electrical cover. Feed the cable(s) through the cable glands. Fix proper cable glands according to IP67 or IP68 protection degree.
- **Fix proper cable glands according to IP67 or IP68 protection degree. Replace the protection plug with suitable metallic protection plug sealed with PTFE. Tighten cable glands and protection plugs to ensure enclosure IP67 (IP68 if applicable).**



- Connect the **internal earth cable terminal**  to the earth connection located inside of electric connection cover (M5 screw hole).
- Connect the **external earth cable terminal**  to the earth connection terminal (See picture)

### Electric actuator with Plug-socket connectors with screws

- Unscrew the attachment plate from the connection cover.
- With a suitable screwdriver, connect the cables for the control signals according to the electric connection diagram.



### Electric actuator with Terminals connection

- With a suitable screwdriver (SD 0,6x3,5 DIN 5264-A), connect the cables for the control signals according to the electric connection diagram.

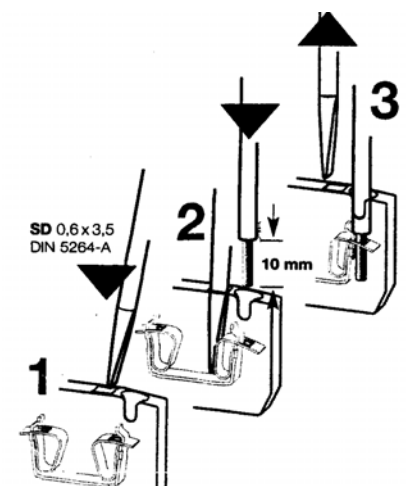
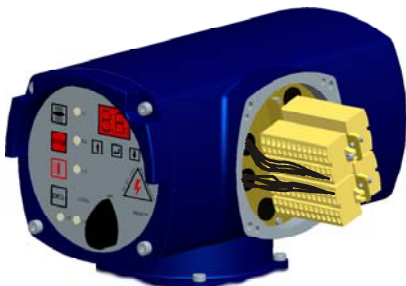

- Once you have checked that the wirings/connections have been properly carried out, close the electric cover checking its o-ring, greasing it slightly. Fasten the 4 screws crosswise.
- Check that all cable glands are correctly tightened.

### 6.3 Cable installation in accordance with EMC

**⚠ Signal cables are susceptible to interference. Motor cables are interference sources.**

- Lay cables being susceptible to interference or sources of interference at the highest possible distance from each other.
- The interference immunity of signal cables increases if the cables are laid close to the ground potential.
- If possible, avoid laying long cables and make sure that they are installed in areas being subject to low interference.
- Avoid long parallel paths with cables being either susceptible to interference or interference sources.
- For the connection of remote signals (Position transmitter, control input, digital output and remote input), screened cables must be used.

### 6.4 Centronik unit on wall bracket (as option)

When required, centronik unit can be mounted apart from the electric actuator (Difficult access to the valve). For centronik with wall bracket assembly option, please observe the following:

- Permissible cable distance between actuator and Centronik unit amounts to a maximum of 100m.
- Use suitable flexible and screened connecting cables.
- All wiring between electric actuator and centronik unit must be done -terminal to terminal- (i.e. terminal 1 to terminal 1, etc), according to enclosed actuator terminal plan.
- Connect the wires in correct phase sequence.
- Check the direction of rotation before switching on.

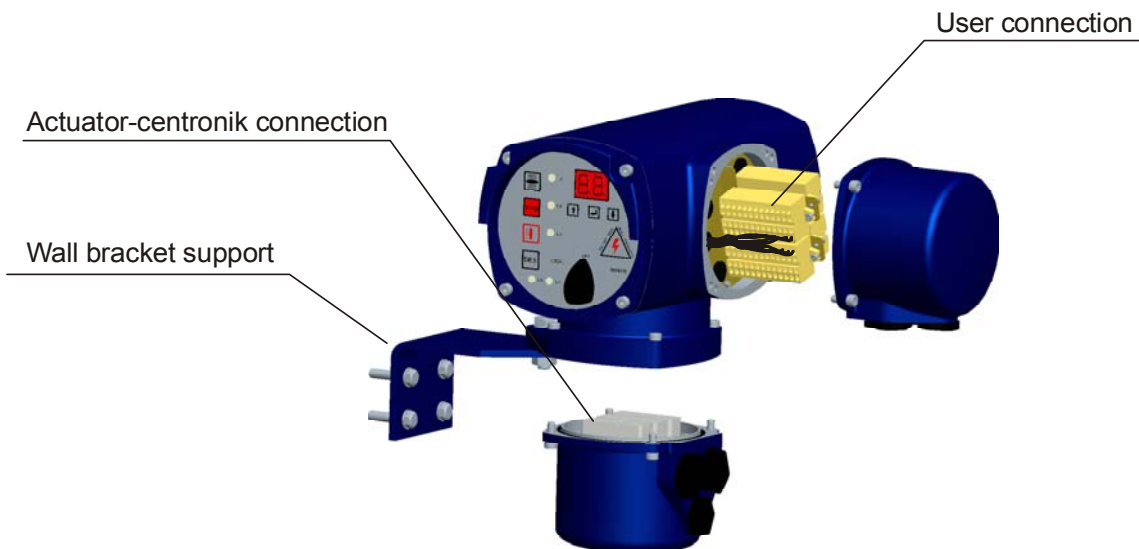

## 7 MANUAL OPERATION

CENTORK actuators are fitted with a handwheel for the manual actuation of the valve. In the case of simultaneous motorised and manual working, the motorised one will always be the preferential one, "**motor priority**".



**Once the handwheel has been engaged is not possible to disengage, the override engagement lever returns automatically to motor position when the motor is operated. Do not press the lever when motor is running.**

Procedure of engagement of manual operation:

- Turn the changeover lever 20° clockwise while slightly turning the handwheel.
- When you notice an increase in the resistance of the wheel, the manual control is engaged.
- Run the valve in the desired direction. Standard sense of rotation is clockwise to close. For greater operating speed you can connect any power tool, pneumatic or electric, to the hand-wheel shaft. The maximum speed allowed is 150 rpm.

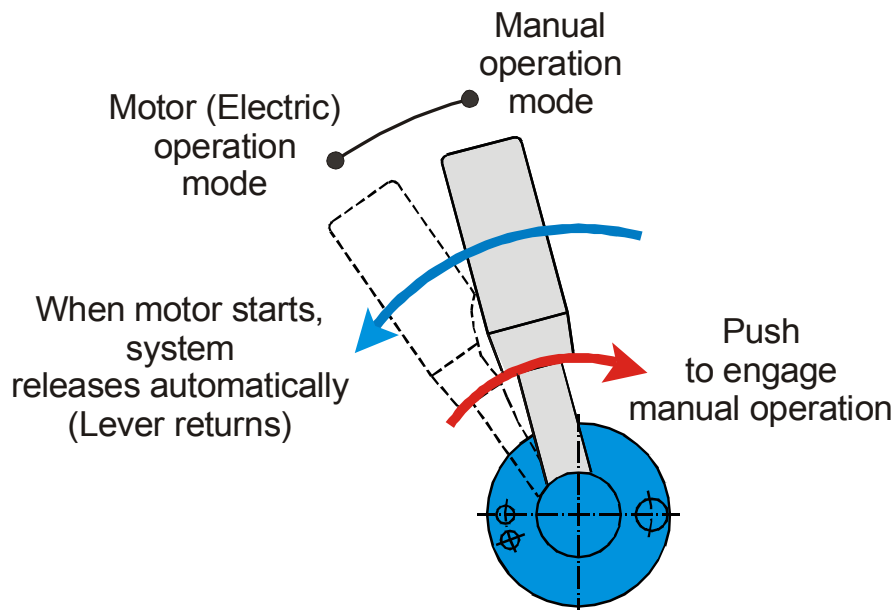
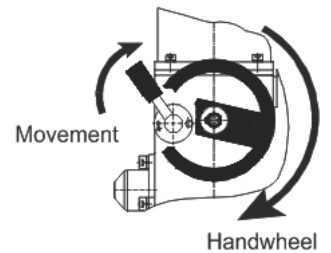

## 8 LOCAL MODE: CONTROL AND DISPLAYS ELEMENTS

The Centronik unit is equipped with local control:

- Pushbuttons:
  - With the OPEN - STOP – CLOSE pushbuttons, the actuator can be operated locally. Push buttons are self-retaining type.
  - With the UP-ENTER-DOWN pushbuttons, the operator can access to the program menu in order to set/change/configure the different parameters, functions and options.
- The LOCAL - OFF - REMOTE selector allows the control mode to be set.
- 5 indication lights show the actuator status from the front panel (chapter 8.3).
- A display shows the actuator status from the front panel:
  - For ***on-off with display*** and ***modulating*** duties centronik units, the display will indicate the real valve position (%opening)
  - For ***on-off*** duty, **the display will remain turn-off.**

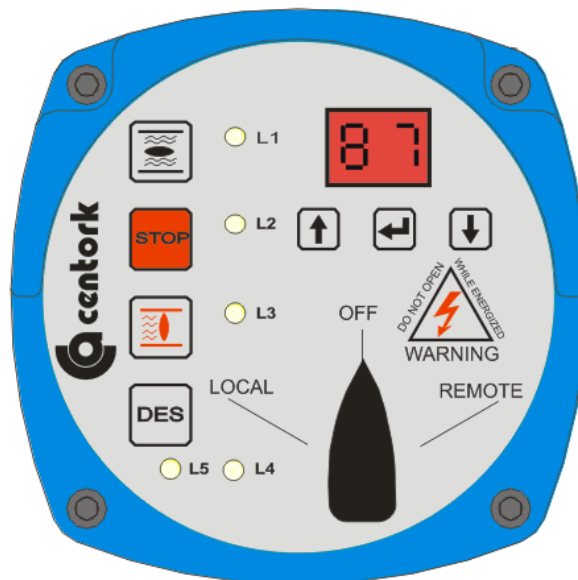

frontal panel

### 8.1 Lockable selector



The selector LOCAL-OFF-REMOTE is lockable in all three positions. Unauthorized operation at the local controls is therefore prevented.



- **OFF**: In this operation mode, the actuator remains connected but does not responds to any order from the front panel or from the remote control. The front panel control indicates only the power supply status (led 5).
- **LOCAL**: With the push buttons OPEN-CLOSE-STOP located on the front panel, the actuator is operated locally.
- **REMOTE**: With the remote commands, the actuator is operated remotely (Remote inputs, see 6.1.1 chapter)

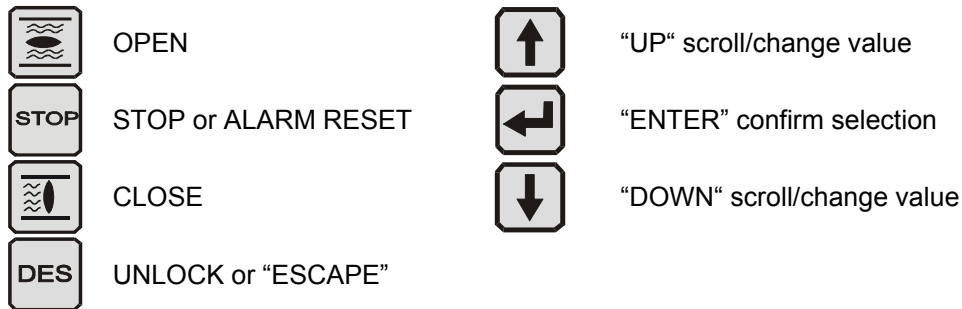

## 8.2 Push-buttons



Pressing  and  with an open torque switch signal enables the user to open:

Pressing  and  with an open torque fault enable the user to close.

**DES** pushbutton in combination with **OPEN** or **CLOSE**: Actuator will start running and will ignore the Open torque (Or the close torque) switch signal for a while (Until a blinker pulse is detected by the centronik unit, then, if torque microswitch is still “energized”, motor will stop again). This function is made for releasing “stuck” valves.

## 8.3 LED indications

Five local LEDs indicate different signal:

<b>L1</b>	<b>Red:</b> <b>Red blinking:</b> <b>Yellow blinking:</b>	OPEN OPENING Limit switch failure
<b>L2</b>	<b>Red:</b> <b>Red blinking:</b> <b>Yellow:</b> <b>Green:</b>	Motor protection tripped Motor protection tripped and has disappeared Movement fault (blinker or TPS) OFF time executing in Stepping mode
<b>L3</b>	<b>Green:</b> <b>Green blinking:</b> <b>Yellow blinking:</b>	CLOSE CLOSING Limit switch failure
<b>L4</b>	<b>Red:</b> <b>Green:</b> <b>Yellow blinking:</b>	OPEN torque fault CLOSE torque fault Torque switch failure
<b>L5</b>	<b>Green:</b> <b>Red:</b> <b>Yellow:</b>	Correct phase connection Lost Phase Inverse phase connection
<b>L1, L2, L3</b>	<b>Yellow:</b>	Rest time executing

## 9 SWITCHING AND SIGNALING UNIT



**CAUTION:** Safety instructions on chapter 2 must be observed. Work at the open actuator under voltage must only be performed if it is assured that for the duration of the work there is no danger of explosion. In other conditions actuator should be carry to a safe area.

Remove 4 bolts and take off the cover at the switching and signalling compartment.



Cover with position indicator



Cover without position indicator

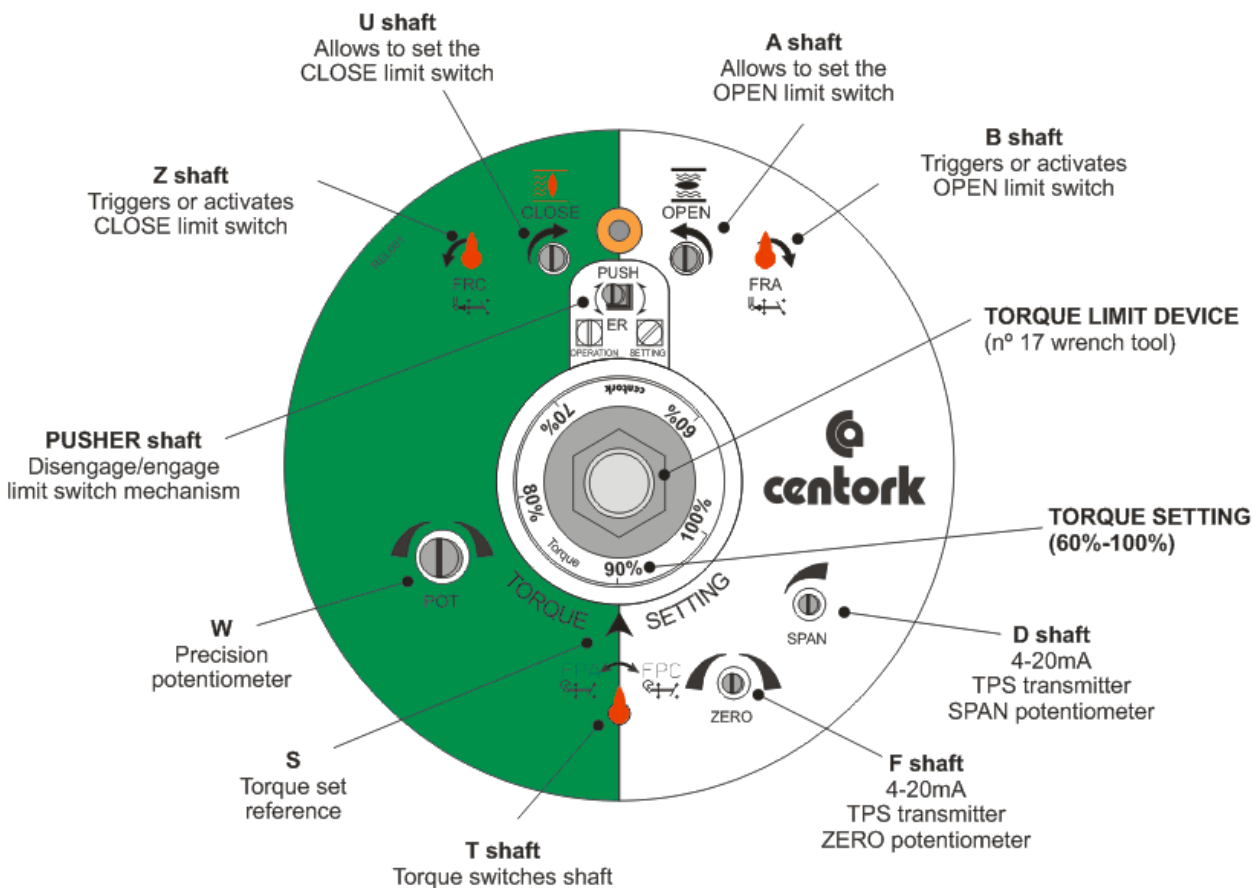

## 10 SETTINGS AND PRELIMINARY TESTS (START-UP)



**CAUTION:** Safety instructions on chapter 2 must be observed. Work on electrical system or equipment must only be carried out by skilled electrician.

- Before to start with the preliminary test, actuator should be correctly mounted on valve and correctly wired as well, according to previous 5 and 0 chapters.
- A commissioning routine is recommended (Visual inspection) according to instructions of 3.2.1 chapter.
- It is recommended to move the valve to middle positions before to do any setting or verification described on next chapters. Operate or move the valve manually (Chapter 7) and check that the actuator rotates in the right direction (Visual disc indicator or valve shaft could help for this). Instructions have been made for standard electric actuators: **CLOCKWISE TO CLOSE**.



**NOTE:** If actuator has been supplied already assembled onto the valve by valve manufacturer, the settings made originally by the manufacturer should **NOT** be modified on site without the authorisation of the latter, otherwise, serious damage may be caused both to the valve and to the actuator.

- Achieve the following setting procedure:

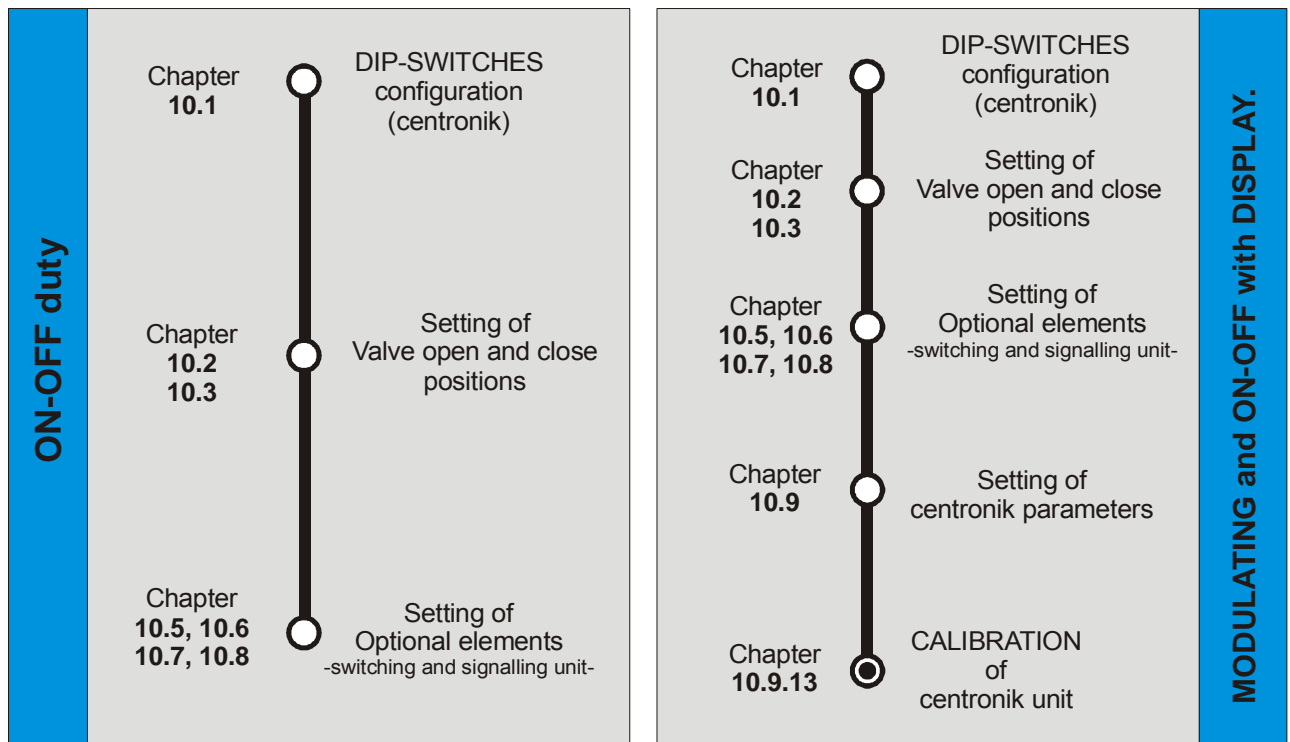

### 10.1 DIP-SWITCHES configuration

**Caution!** This is a sensitive electronic device. Manipulation of setting switches should be made very carefully, in a way that other electronic components are not damaged.

In order to configure the Dipswitches, switch-off the Centronik unit (led 5 OFF) and open the centronik front panel carefully. In the CPU board, the DIPSWITCHES are located as indicated in the next figure.

**Once the DIPSWITCHES have been configured, close the frontal panel: Check that NO wire is trapped by frontal panel, before closing the panel, and verify that o-ring is not damaged or cut. Centronik frontal panel has to be correctly tightened.**

CELLS in grey colour: CENTORK FACTORY STANDARD.



#### 10.1.1 Operation mode

SW1	SW2	SW3	Operation mode
ON	OFF	OFF	Open by limit switching and close by torque switching
OFF	ON	OFF	Open and close by limit switching
ON	ON	OFF	Open and close by torque switching

**Note:** Open or close by torque switching means that the Centronik consider that the valve is closed or opened when the open/close limit switch and the open/close torque switch are activated, otherwise, the Torque signal can be considered as an overtorque condition in middle position. Limit switch must be adjusted as in **Open and close by limit switch**.

#### 10.1.2 Centronik output signals configuration (Only in ON/OFF duty)

SW5	SW6	SW7	OUTPUT 1	OUTPUT 2	OUTPUT 3	OUTPUT 4	OUTPUT 5
OFF	OFF	OFF	Valve OPEN	Valve CLOSE	LOCAL	REMOTE	ANOMALY
ON	OFF	OFF	Overtorque reached in OPEN	Overtorque reached in CLOSE	LOCAL	REMOTE	ANOMALY
OFF	ON	OFF	Valve OPEN	Overtorque reached in CLOSE	LOCAL	REMOTE	ANOMALY
ON	ON	OFF	Valve OPEN	Valve CLOSE	Overtorque reached in OPEN	Overtorque reached in CLOSE	ANOMALY
OFF	OFF	ON	Valve OPEN	Valve CLOSE	Overtorque	Motor overheat (Motor protection tripped)	ANOMALY

**Anomaly:** Any of the following events: Limit switch fault, torque switch fault, blinker fault, lost phase or Motor thermal protection tripped.

### 10.1.3 Actuator and valve (Sense of rotation)



Electric actuator and valve sense of rotation must be the same. Electric actuator sense of rotation criteria is **CLOCKWISE TO CLOSE**. Sense of rotation is critical for many components (Microswitches, potentiometer, 4-20mA transmitter). A correct operation cannot be warranty in case of different sense of rotation valve/actuator.

- Operate the Electric actuator via handwheel (See Manual operation, chapter 7).
- Check that running the handwheel clockwise, valve moves to close. If the turn direction is not correct, stop immediately and verify.
- Configure the DIPSWITCH 4.

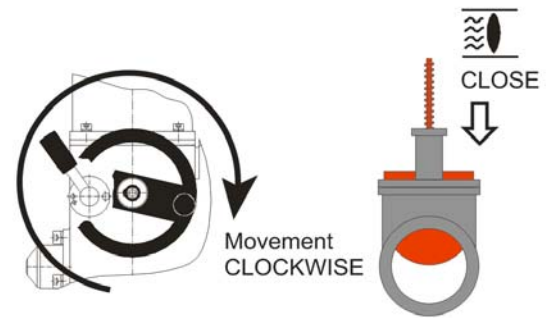

SW4	Direction to close
ON	Anti-clockwise
OFF	Clockwise



Instructions have been made for standard electric actuators: **CLOCKWISE TO CLOSE**. In case of **ANTI-CLOCKWISE “ON”** dipswitch SW4 must be activated, contact **CENTORK**.

### 10.1.4 Posicion transmitter range (only in Modulating duty and ON/OFF duty with position display)

SW6	TPS range
OFF	0/20mA
ON	4/20mA

Note: the **SW6** must be configured in accordance to the TPS setting (Chapter 10.8).

### 10.1.5 Remote mode selection

SW8	Remote mode selection
ON	Analogue input control (modulating duty) Parallel input control (ON/OFF duty)
OFF	Fieldbus (Optional)

Once the **DIPSWITCHES** have been configured, close the frontal panel: Check that **NO** wire is trapped by frontal panel, when closing and verify that o-ring is not damaged or cut. Centronik frontal panel has to be correctly tightened.

## 10.2 Closed position limit switch setting

- Manually turn the valve to the desired valve CLOSED position.
- Disengaged **PUSHER** shaft (Figure 10.2-2): With a suitable screwdriver press the **PUSHER** shaft 3 mm and turn it 45°, ensure that it does not return to its original height (Figure 10.2-1).
- Note: **PUSHER** shaft allow to engage/disengage the switching and signalling unit from Electric actuator gears. (Figure 10.2-1 and Figure 10.2-2).

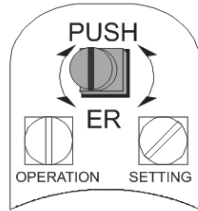

Figure 10.2-1

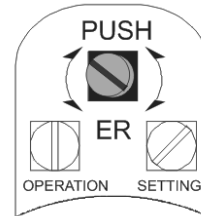

Figure 10.2-2

- Turn **U** spindle clockwise (Figure 10.2-3) until **Z** spindle turns Counter-clockwise (At this moment FRC microswitch triggers). Just before FRC microswitch was tripped, **Z** red arrow should be pointed to vertical: When **Z** spindle (Red arrow) turns to left the FRC microswitch is tripped (Figure 10.2-4).
- If, by accident, it has been carried on turning past the tripping of the FRC microswitch, turn spindle **U** in the opposite direction (counter-clockwise) until the **Z** spindle returns vertical (Figure 10.2-5)

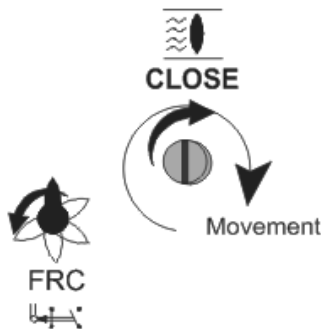

Figure 10.2-3

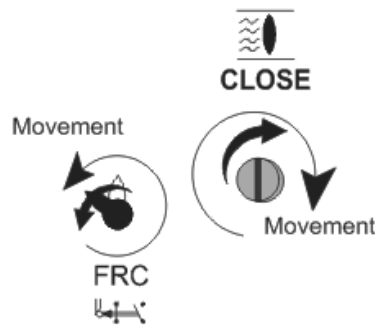

Figure 10.2-4

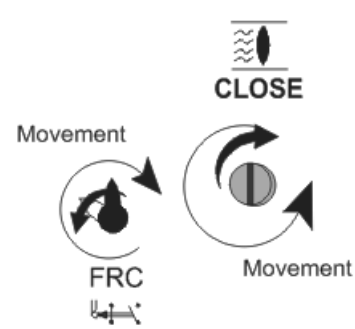

Figure 10.2-5



- **ENGAGE PUSHER SHAFT:** Turn back PUSHER shaft. Check that goes back to its initial position (Figure 10.2-1). **This point is fundamental for the correct setting of the limit switches: Ensure that PUSHER shaft is correctly engaged.**

NOTE: For greater speed in long runs, small electric or pneumatic screwdriver can be used. Max allowable input speed cannot exceed 200 rpm.

### 10.3 Open position limit switch setting

- Manually turn the valve to the desired valve OPEN position.
- Disengaged **PUSHER** shaft (Figure 10.2-2): With a suitable screwdriver press the **PUSHER** shaft 3 mm and turn it 45°, ensure that it does not return to its original height (Figure 10.2-1).
- Note: **PUSHER** shaft allow to engage/disengage the switching and signalling unit from Electric actuator gears. (Figure 10.2-1 and Figure 10.2-2).
- Turn **A** spindle Counter-clockwise (Figure 10.3-1) until **B** spindle turns clockwise (At this moment FRA microswitch triggers). Just before FRA microswitch was tripped, **B** red arrow should be pointed to vertical: When **B** spindle (Red arrow) turns to right the FRA microswitch is tripped (Figure 10.3-2).
- If, by accident, it has been carried on turning past the tripping of the FRA microswitch, turn spindle **A** in the opposite direction (clockwise) until the **B** spindle returns to vertical (Figure 10.3-3).

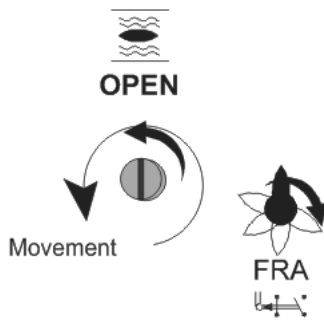

Figure 10.3-1

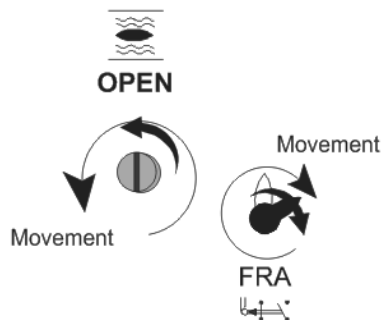

Figure 10.3-2

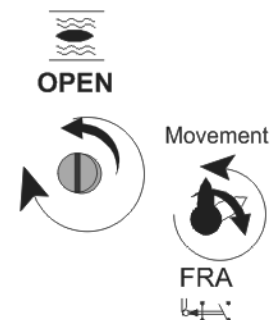

Figure 10.3-3



- **ENGAGE PUSHER SHAFT:** Turn back **PUSHER** shaft. Check that goes back to its initial position (Figure 10.2-1). **This point is fundamental for the correct setting of the limit switches: Ensure that PUSHER shaft is correctly engaged.**

NOTE: For greater speed in long runs, small electric or pneumatic screwdriver can be used. Max allowable input speed cannot exceed 200 rpm.

### 10.4 Torque switching setting

CENTORK Electric actuators leave the factory tested and set for its Max. Torque (100%), as standard. Adjustment torque range is 60% up to 100% of Max. Torque rated on nameplates.



**Guarantee is not valid if the user exceeds this range (60%-100%).**

#### Torque mechanism design

Torque mechanism always acts as soon as actuator output torque exceeds the value set (Torque setting). It is used as protection throughout the whole valve travel. It also remains active during manual operation, thereby protecting the valve from any torque excess caused by the handwheel.

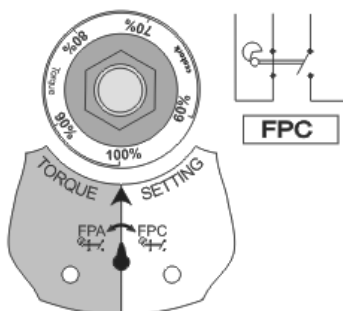

Figure 10.4-1

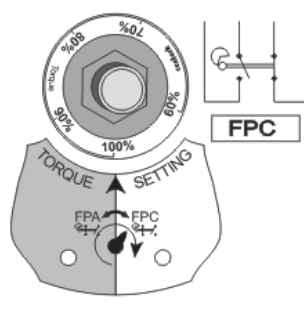

Figure 10.4-2

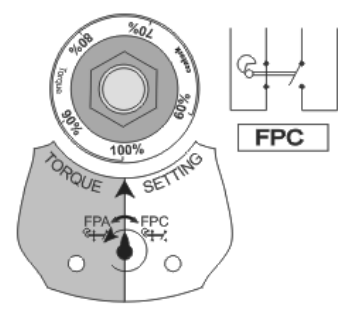

Figure 10.4-3

- When torque on valve shaft exceeds the value set, e.g. running to close, shaft **T** turns to the right (Pointing to FPC), at the same time **TORQUE LIMIT DEVICE** releases (Figure 10.4-1 and Figure 10.4-2). FPC microswitch is tripped. Automatically, or when actuator starts running to opposite direction, mechanism returns or resets. Notice that **TORQUE LIMIT DEVICE** latches again (Figure 10.4-3).

Torque setting Procedure:

- Using a No.17 wrench, turn the **TORQUE LIMIT DEVICE** until the desired torque matches with the arrow **S** on the dial. (Figure 10.4-4 and Figure 10.4-5).

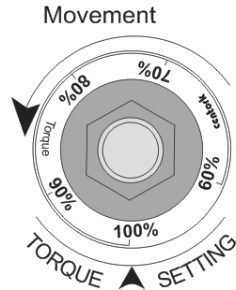

Figure 10.4-4

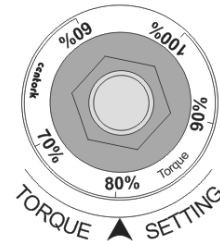

Figure 10.4-5

## 10.5 Mechanical position indicator setting (optional)

**Limit switches must be set before!**

Mechanical Position Indication dial turns between CLOSE and OPEN position depending on the actuator model and valve stroke. This is achieved with the addition of a suitable gearing according to the number of turns per valve stroke. If the latter varies, the gearing must be changed.

Procedure:

- Run actuator to the CLOSED position.
- Unscrew the bolt and turn the dial with the symbol (CLOSED) until it matches with the mark ◀ on cover.
- Run actuator to the OPEN position, and proceed exactly with disc containing OPEN symbol.
- Screw the bolt

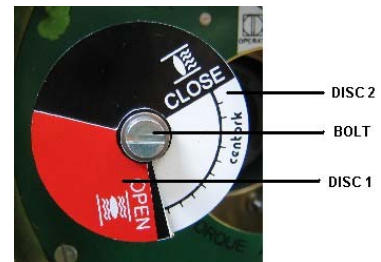

## 10.6 Auxiliary limit switches setting (optional)

**Limit switches must be set before!**

Procedure:

- When actuator is fitted with a mechanical position indicator, remove its discs with a screwdriver.
- Run the actuator to the position needed to set auxiliary limit switch AUX1
- With a No. 2 Allen key loosen the bolt in the cam corresponding to the auxiliary limit switch AUX1. Turn this cam until it triggers or trips the limit switch AUX1.
- Work the actuator in both directions, checking that the limit switch AUX1 correctly switches.
- Repeat points 2 to 4 for auxiliary limit switches AUX2, and AUX3.
- If the actuator was fitted with a mechanical position indicator, reinstall it.

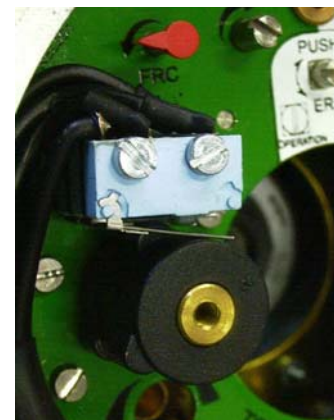



## 10.7 Potentiometer POT setting (optional)

### Limit switches must be set before!

Potentiometer is selected according to valve stroke. A suitable gearing unit reduce valve stroke (Number of turns) to less than one turn, this movement is measured by potentiometer located on switching and signalling unit.

Procedure:

- Run the actuator to the CLOSED position.
- With a suitable screwdriver, turn the **W** spindle of the potentiometer POT, counter-clockwise, to its top end.
- Check that potentiometer value is close to 0 Ohms.
- Run the actuator to the OPEN position.
- Check that potentiometer value reaches its maximum value (Ohms), which depends of the valve stroke.

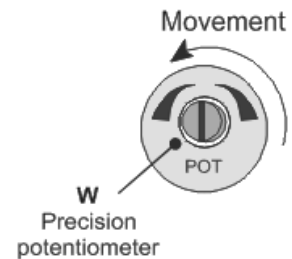

**CAUTION: The potentiometer is a high precision electromechanical device and should be handled carefully. It is necessary to use a suitable screwdriver for its setting.**

## 10.8 0/4-20mA transmitter TPS setting (optional)

**Modulating and on-off with display centronik units: TPS electronic position transmitter is already included. This element must be adjusted for a correct operation.**

### Limit switches must be set before!

0/4-20 mA transmitter are selected according to valve stroke. A suitable gearing unit reduce valve stroke (Number of turns) to less than one turn, this movement is measured by potentiometer, and converted to current signal by TPS transmitter. If valve stroke changes, TPS may not work properly.

Procedure:

- Run the actuator to the CLOSED position (sensor in minimum signal).
- With a suitable screwdriver, turn the **W** spindle of the potentiometer POT, counter-clockwise, to its top end.
- Adjust the output current with the ZERO (**F** spindle) trimmer potentiometer until its reading is close to 4mA or 0mA
- Run the actuator to the OPEN position (sensor in maximum signal).
- Adjust the output current with the SPAN (**D** spindle) trimmer potentiometer until its reading is close to the maximum current of 20mA.
- Run the actuator back to the CLOSED position and check that the minimum current is 4mA or 0mA. If this is not the case, repeat points 1, 3, 4 and 5 until optimum adjustment values are reached.

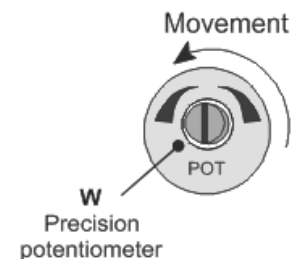

**CAUTION: The TPS electronic position transmitter is a high precision electronic device and should be handled carefully. It is necessary to use a suitable screwdriver for its setting.**

### 10.9 CENTRONIK setting procedure (only Modulating and On-Off with display units)

For **on-off with display** and **modulating** duties centronik units, by mean of the program mode it is possible to select and configure the centronik parameters, functions and features.

**In order to access to this “program mode” is necessary to switch the centronik selector in LOCAL mode and introduce the correct PASSWORD.**

All the setting functions are stored in a non-volatile memory in the CENTRONIK unit. The front panel enables the user to view all the functions via the display, and change it, when required. Notice that there is not a “restore function” when changes are made.

The setting procedure include the following functions:

- Control input signal
- Polarity
- Control input and TPS setting
- Deadband
- Rest time
- Close tightly
- Valve opening curves
- Zero and span for Control input and TPS
- Autolearn
- Digital outputs
- Operation mode Emergency Shut Down
- Blinker
- Data logging
- Password
- Inching mode
- Stepping mode



**The setting procedure (See figure on 10 chapter) must be followed in order to adjust/set correctly the Centronik Unit: DIP-switches, Limit switches and optional elements must be set before!**

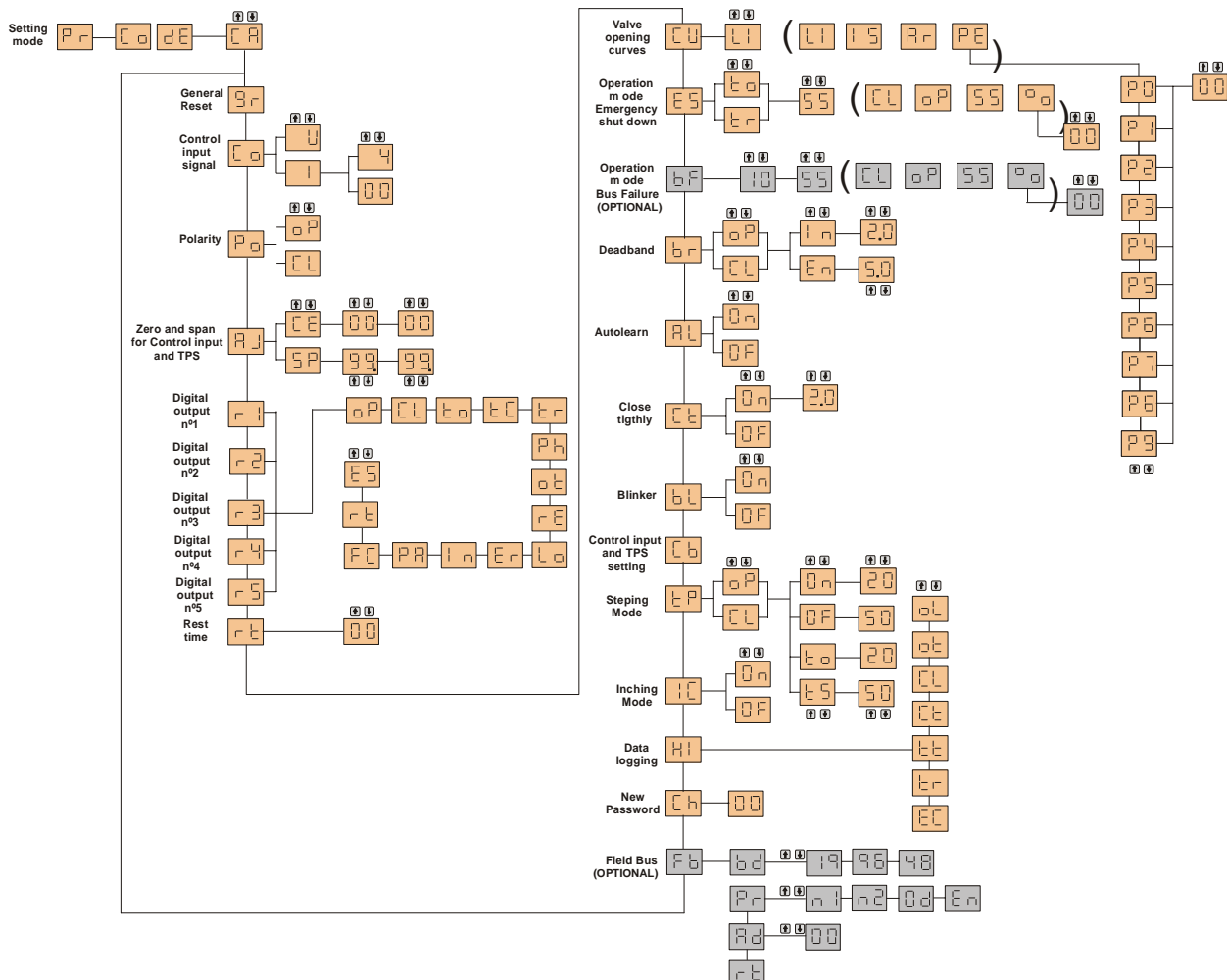









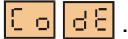

### 10.9.1 Access to program mode – Password

**In order to access to this “program mode” is necessary to switch the centronik selector in LOCAL mode and introduce the correct PASSWORD.**

The factory set (default) password is “CA”.

Procedure:













- Press the  key during 3 seconds.
- The display will change to .
- Press the  key.
- The display will change to .
- Press the  key.
- The display will change to .
- Use the  or  keys to scroll through the available password 00-FF (hexadecimal).
- With the correct password display press the  key.
- If the password is incorrect, display will change to . Press the  key and enter the correct password.
- In order to return to the valve position display there are 2 ways: Press the  key or select OFF Control using the selector.

### 10.9.2 Control input signal (only in Modulating duty)









The modulating duty is a position controller. It compares the input signal and the position transmitter (TPS). The actuator then runs in direction OPEN or CLOSE, subject to the deviation detected. The control input signal is an analogue signal programmed as 0-20mA, 4-20mA or 0-5V.

The control input signal is factory standard 4-20mA.

Procedure:

- Enter in the setting mode (chapter 10.9.1)
- Press the  or  key to select the Control input signal menu .
- Press the  key.
- The display will change to .
- Use the  or  keys to scroll through the available password 00-FF (hexadecimal). The password will only be provided if necessary. Consult CENTORK.
- With the correct password display press the  key.
- Press the  key.
- Press the  or  key to select the Control input mode:  
 Voltage control input       Current control input

Note: Voltage control is an optional control device.

- With the selected mode press the  key.
- Press the  key.
- Press the  or  key to select the Control input range in case of Current control input:  
 4-20mA       0-20mA
- With the selected range press the  key.
- Press the  key.

### 10.9.3 Polarity (only in Modulating duty)

The polarity permit to reverse the control input (or set position) with the actual position comparison.

The Polarity is factory standard CLOSE.

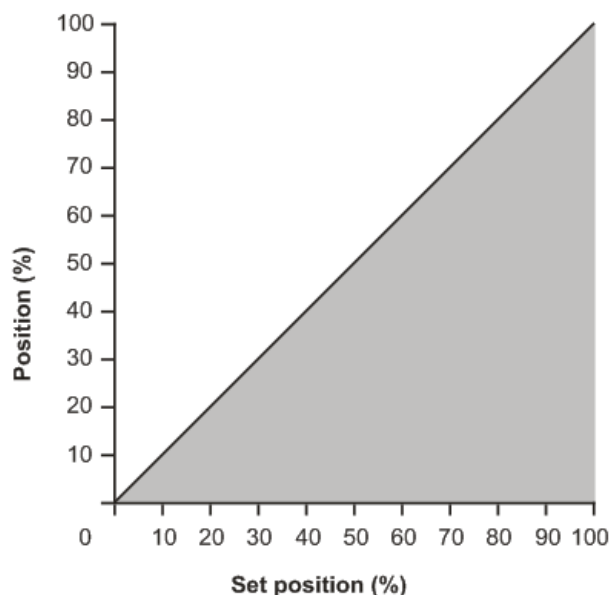



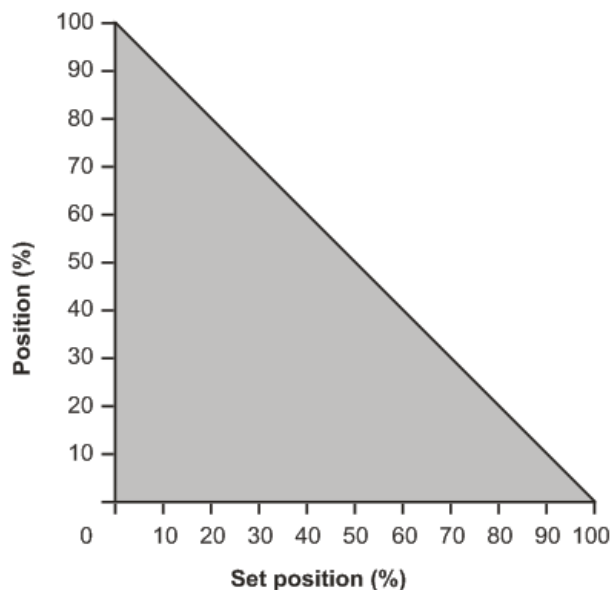







Minimal control input for CLOSE



Minimal control input for OPEN

Procedure:

- Enter in the setting mode (chapter 10.9.1)
- Press the  or  key to select the Polarity menu .
- Press the  key.
- Press the  or  key to select the Polarity mode:
 

 Minimal control input for CLOSE	 Minimal control input for OPEN
---	--
- With the selected polarity press the  key.
- Press the  key.

### 10.9.4 Zero and span for Control input and TPS –feedback signal- (only in Modulating duty)

This function enables the control input range (zero, span) to be fitted to the valve stroke and this one to be limited to a given MIN (zero) and MAX (span) percentage. This section is also useful for programming the split-range working mode. Split range allows the adaptation of the positioner to control input ranges which are for example necessary to individually control several actuators with the same control input signal. Typical values for two actuators are 0-10mA and 10-20mA.

The zero for Control input and TPS is factory standard 0%(00). The span for Control input and TPS is factory standard 100% (99. on display).

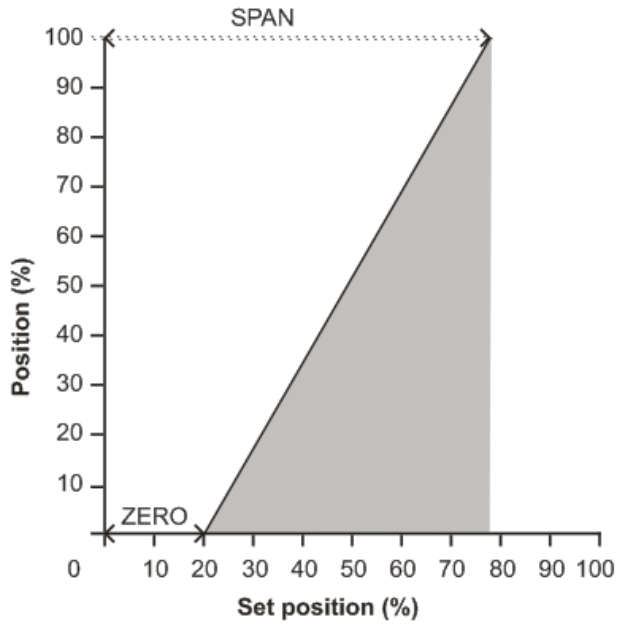



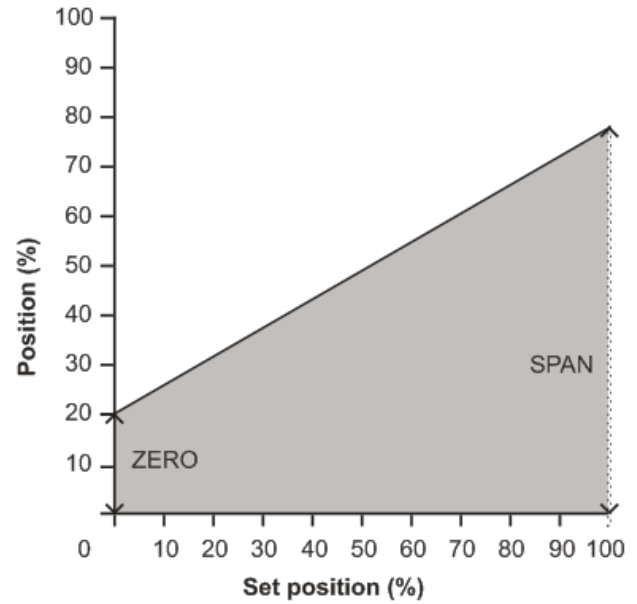





















Zero and span for Set position (Control input)



Zero and span for TPS (position transmitter)

Procedure:

- Enter in the setting mode (chapter 10.9.1)
- Press the  or  key to select the zero and span menu .
- Press the  key.
- The display will change to .
- Press the  key.
- Press the  or  key to select the zero for Control input.
- With the selected value press the  key.
- Press the  key.
- Press the  or  key to select the zero for TPS.
- With the selected value press the  key.
- Press the  key.
- The display will change to .
- Press the  key.
- Press the  or  key to select the span for Control input.
- With the selected value press the  key.
- Press the  key.
- Press the  or  key to select the span for TPS.
- With the selected value press the  key.
- Press the  key.

### 10.9.5 Outputs signals (Digital or relays outputs)





The digital outputs or Relay outputs indicate the actuator state. Five digital outputs are available and programmable. See Appendix for more details.

Digital outputs R1, R2, R3, R4 and R5 may each be set to trip for the desired function.

The digital outputs is factory standard:



**r1** = **oP**    **r2** = **CL**    **r3** = **ot**    **r4** = **rt**    **r5** = **tr**

Procedure:

- Enter in the setting mode (chapter 10.9.1)
- Press the  or  key to select the digital outputs menu **r1**.
- Press the  key.
- Press the  or  key to select the required function:

<b>oP</b> Valve OPEN	<b>Er</b> Anomaly
<b>CL</b> Valve CLOSE	<b>rE</b> Remote selected
<b>to</b> Overtorque reached in OPEN	<b>Lo</b> Local selected
<b>tC</b> Overtorque reached in CLOSE	<b>in</b> Intermediate position
<b>tr</b> Motor protection tripped	<b>PA</b> Position reached (Only in Modulating duty)
<b>Ph</b> Lost phase (only for 3 phases systems)	<b>FC</b> Command signal failure (Only in Modulating duty)
<b>ot</b> Overtorque	<b>rt</b> Rest time
	<b>ES</b> ESD signal (only in Modulating duty and ON/OFF duty with position display)

Anomaly: Motor protection tripped, limit or torque switch fault, movement fault or lost phase.

- With the selected function press the  key.
- Press the  key.

The procedure for setting up digital outputs R2, R3, R4 and R5 are the same as those shown for R1.







### 10.9.6 Rest time

The rest time is the time after a reach position or OPEN/CLOSE/STOP action that other changes in the nominal value or CLOSE/OPEN action are ignored by the Centronik unit in order to filter major fluctuations within the nominal value and to reduce number of start.

**The Rest time prevents the operation to a new nominal position or OPEN/CLOSE action within a predetermine time.**

The rest time is factory standard 0s.

Procedure:

- Enter in the setting mode (chapter 10.9.1)
- Press the  or  key to select the Rest time menu **rt**.
- Press the  key.
- Press the  or  key to select between **00** and **60** s.
- With the selected Rest time value press the  key.
- Press the  key.

Note: LEDs 1, 2 and 3 light yellow when the Centronik unit execute the rest time



**CAUTION: It must be ensured via the control that the maximum permissible number of starts of the actuator is not exceeded. This can be achieved by setting the rest time to a sufficiently high enough value.**

### 10.9.7 Valve opening curves (only in Modulating duty)

This function enables a transmission characteristic curve with regard to the desired value of set position (Control input) and valve stroke for correction of the flow or operating curve to be chosen.

The Valve opening curves is factory standard Linear.

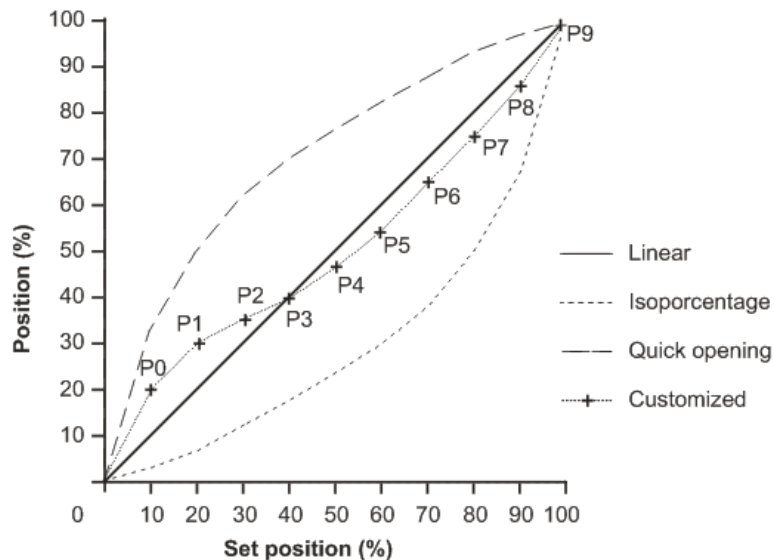

Procedure:

- Enter in the setting mode (chapter 10.9.1)
- Press the or key to select the valve opening curves menu .
- Press the key.
- Press the or key to select the valve opening curve required:
  - Linear opening curve
  - Isopercentage opening curve
  - Quick opening curve
  - Customized opening curve
- With the selected valve opening curve press the key.
- Press the key.
- If the customized opening curve is selected, press the or key to select the valve opening point (P0 to P9.).

Point	P0	P1	P2	P3	P4	P5	P6	P7	P8	P9
Control input (%)	10	20	30	40	50	60	70	80	90	100
Position required (%)										







- Press the key.
- With the selected point value press the key.
- Press the key.
- Repeat this procedure for each valve opening point (P0 to P9.)
- In order to return to previous menu press the .







### 10.9.8 Operation mode ESD (only in Modulating duty and ON/OFF duty with position display)











In remote mode, an “Emergency Shut Down” signal applied to the actuator will override any existing or applied remote control signal. ESD ignore all securities except the override setting (motor thermostat or torque limit switches).

The factory standard under an active signal is “standstill” position considering motor thermostat.

Procedure:

- Enter in the setting mode (chapter 10.9.1)
- Press the  or  key to select the ESD menu .
- Press the  key.
- Press the  or  key to select the required ESD override setting:
 

 Motor thermostat	 Torque limit switches
--	---
- With the selected ESD override press the  key.
- Press the  key.
- Press the  or  key to select the required ESD action:
 

 OPEN on ESD	 “Standstill” on ESD
 CLOSE on ESD	 Reach the ESD desired position (only in Modulating duty).
- With the selected ESD action press the  key.
- Press the  key.
- In case of  action, Use the  or  keys to scroll through the available desired position 00-100.
- With the selected value press the  key.
- Press the  key.

### 10.9.9 Deadband (only in Modulating duty)

There are two deadbands for each operation sense (opening and closing), the outer deadband and the inner deadband:

- The outer deadband determines the switching-on point of the actuator.
- The inner deadband determines the switching-off point of the actuator.





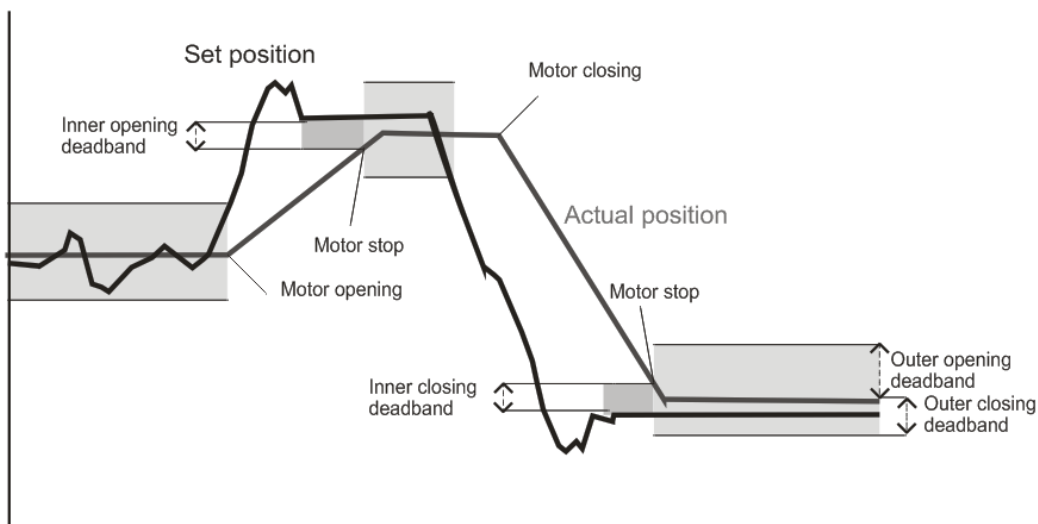













The deadband is factory standard 2% for inner deadbands and 5% for outer deadbands.

If the Autolearn menu is activated (ON), it is not necessary to adjust the deadband values.





Procedure:

- Enter in the setting mode (chapter 10.9.1)
- Press the  or  key to select the Deadband menu .
- Press the  key.
- Press the  or  key to select between Opening  and Closing  deadbands.
- Press the  key.
- Press the  or  key to select between Inner  or Outer  deadbands.
- Press the  key.
- Press the  or  key to change the value for the selected deadband between 0,5% and 2,0% for the inner deadband and between 1,0% and 5,0% for the outer deadband in 0,5% step.
- With the selected deadband value press the  key.
- Press the  key.
- In order to return to previous menu press the  key.













**CAUTION: Outer deadbands must be greater than inner deadband. If the actuator hunts or responds unnecessarily to a fluctuating set position signal (control input) the deadband must be increased. If more accurate control is required the deadband may be decreased.**

#### 10.9.10 Autolearn (only in Modulating duty)

An automatic adaptation of the deadbands is suitable with Autolearn function.

The Autolearn is factory standard OFF (deactivated).

Procedure:

- Enter in the setting mode (chapter 10.9.1)
- Press the  or  key to select the autolearn menu .
- Press the  key.
- Press the  or  key to select between  (autolearn activated) or  (autolearn deactivated).
- With the selected activation/deactivation press the  key.
- Press the  key.











#### 10.9.11 Close tightly (only in Modulating duty)





**Close tightly ensures that the actuator opens and closes fully, when activated, it ignores the death bands, near to end positions.**

If the nominal value (control input) 0/4 mA or 20 mA for the approaching of the end positions is not reached, a “close tightly” tolerance for the nominal value can be set within the range of the end positions. If the tolerance is exceeded or not reached, the actuator continues the operation until the full end position has been reached.

The close tightly is factory standard OFF (deactivated).

Procedure:

- Enter in the setting mode (chapter 10.9.1)
- Press the  or  key to select the Close tightly menu .
- Press the  key.
- Press the  or  key to select between  (close tightly activated) or  (close tightly deactivated).
- With the selected activation/deactivation press the  key.
- Press the  key.











- If close tightly is activated (ON), press the  or  key to select the close tightly range between 0.5% and 2% in 0,5% step.
- With the selected value press the  key.
- Press the  key.

#### 10.9.12 Blinker (only in Modulating duty and ON/OFF duty with position display)

Blinker transmitter allows to detect movement of the actuator. Blinker detection can be switched on or off. If the detection is switched off, the movement detection is suitable with the position transmitter (TPS).

**The blinker is factory standard ON (activated).**

Procedure:

- Enter in the setting mode (chapter 10.9.1)
- Press the  or  key to select the blinker menu .
- Press the  key.
- Press the  or  key to select between  (blinker activated) or  (blinker deactivated).
- With the selected activation/deactivation press the  key.
- Press the  key.

#### 10.9.13 Calibration of the CENTRONIK unit







**This step/instruction is mandatory for a correct operation of CENTRONIK modulating and on/off with display duties.**



**This function calibrates the centronik unit with the control INPUT signal (user, 20mA) and valve position –feedback signal- given by the electronic position transmitter TPS (20mA): The set point and the actual position (Centronik unit, 100%). This calibration will ensure a correct operation in Remote mode!**

**Limit switches and 0/4-20mA transmitter must be set before!**

Procedure:











- Before making the calibration, the valve should be brought to the maximum opening position, therefore the TPS should be supplying the maximum current (20mA). For modulating duty, the control input signal should be supplying the maximum current (20mA).
- Enter in the setting mode (chapter 10.9.1)
- Press the  or  key to select the Calibration menu .
- Press the  key.
- The display will change to a blinking hexadecimal value.
- Press the  and  key simultaneously to record the calibration. The display will stop blinking.
- Press the  key.

#### 10.9.14 Inching mode (only in ON/OFF duty with position display)

- With **self-retaining operation**, the actuator continues to run as long as the STOP command from the control system (digital input) is not being generated, or any centronik operation condition takes place (Inching mode OFF).
- With **push to run operation (Inching mode)** the actuator continues to run as long as this command from the control system (digital input) remains (Inching mode ON).

The Inching Mode is factory standard OFF (deactivated).

Procedure:

- Enter in the setting mode (chapter 10.9.1)
- Press the  or  key to select the Inching mode menu .
- Press the  key.
- Press the  or  key to select between  (push to run) or  (self-retaining).
- With the selected activation/deactivation press the  key.
- Press the  key.

10.9.15 Stepping mode (only in ON/OFF duty with position display)

The stepping mode is used to increase the operating time for the entire or any portion of the valve travel. Different operating times can be realised without using two-speed motors. Start and end of stepping mode as well as ON and OFF time can be programmed individually for the directions OPEN and CLOSE.

The Stepping Mode is factory standard OFF (deactivated):

- |               |               |
|---------------|---------------|
| • CL-OF: 60%. | • ON-OF: 40%. |
| • CL-ON: 40%. | • ON-ON: 60%. |
| • CL-To: 1s.  | • ON-To: 1s.  |
| • CL-Ts: 10s. | • ON-Ts: 10s. |

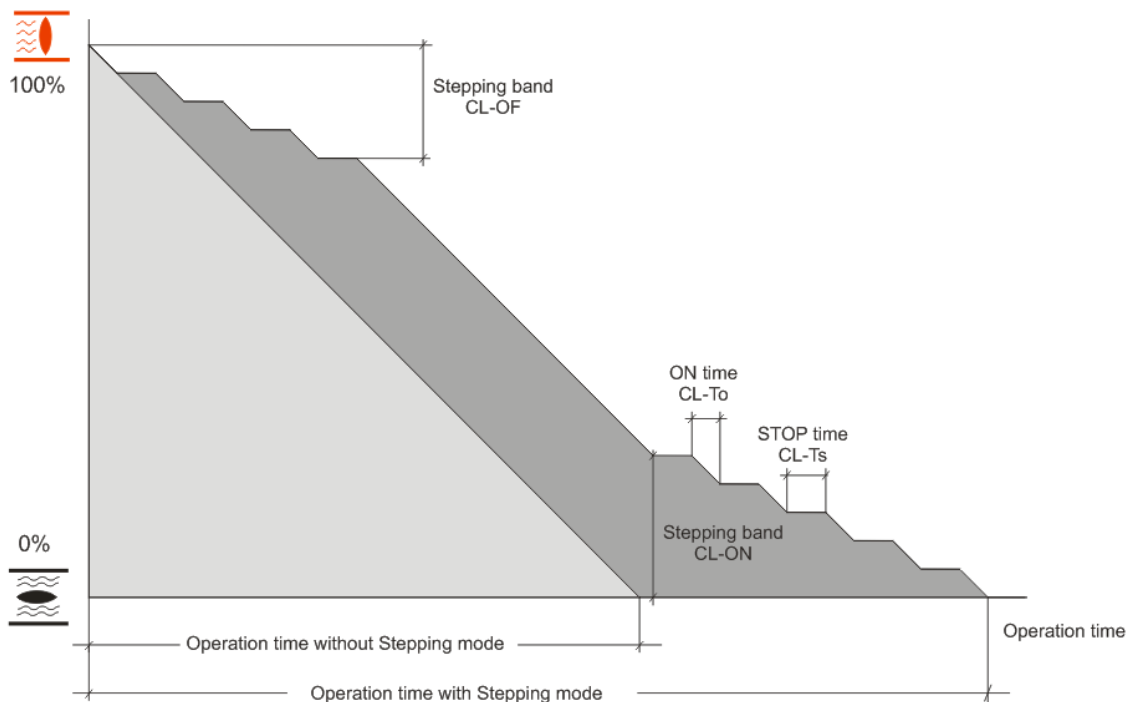



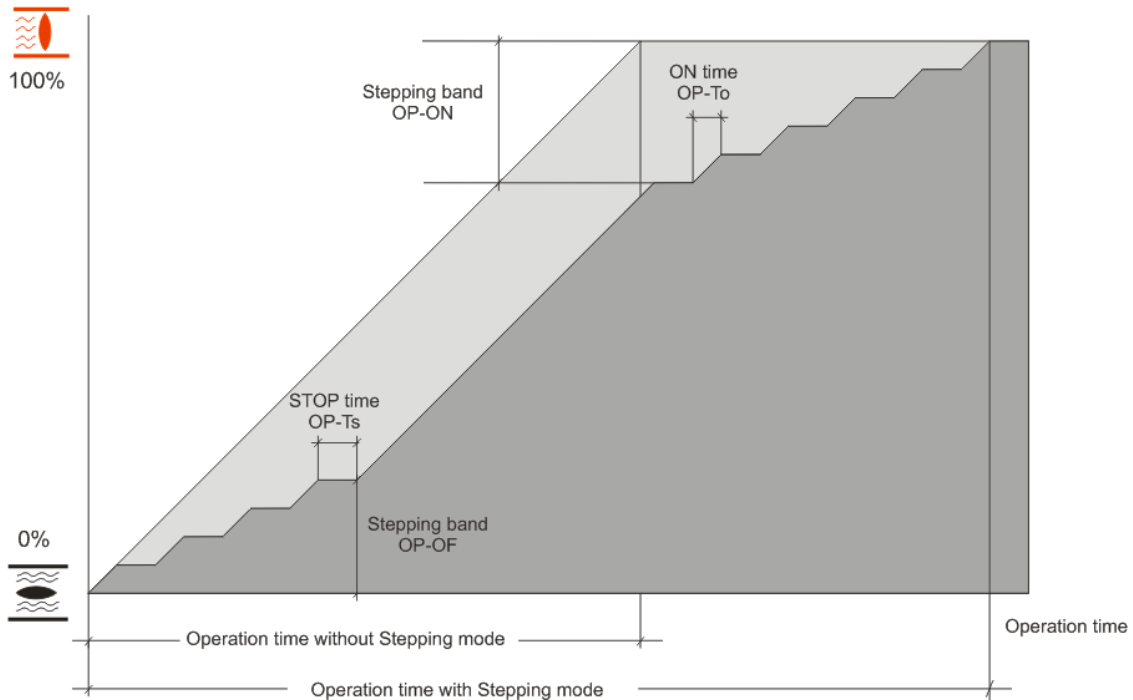























- CL-OF: Direction CLOSE, first stepping operation then normal operation.
- CL-ON: Direction CLOSE, first normal operation then stepping operation.
- CL-To: Running time in direction CLOSE.
- CL-Ts: OFF time in direction CLOSE.



- OP-OF: Direction OPEN, first stepping operation then normal operation.
- OP-ON: Direction OPEN, first normal operation then stepping operation.
- OP-To: Running time in direction OPEN.
- OP-Ts: OFF time in direction OPEN.

Procedure:

















- Enter in the setting mode (chapter 10.9.1)
- Press the  or  key to select the Stepping mode menu .
- Press the  key.
- Press the  or  key to select between  (stepping mode activated) or  (stepping mode deactivated).
- With the selected activation/deactivation press the  key.
- Press the  or  key to select between Opening  and Closing  bands.
- Press the  key.
- Press the  or  key to select between , ,  y .
- Press the  key.
- Press the  or  key to change the value for the selected parameter (0 to 100% for ON and OF parameters in 1% step and 0 to 60s for to and tS parameters in 1s step).
- With the selected value press the  key.
- Press the  key.
- In order to return to previous menu press the  key.



**CAUTION: OP-ON must be greater than OP-OF and CL-OF must be greater than CL-ON.**







### 10.9.16 Data logging

Procedure:

- Enter in the setting mode (chapter 10.9.1)
- Press the  or  key to select the data logging menu .
- Press the  key.
- Press the  or  key to select the data logging required.
  -  N° of opening operations       Total running hours
  -  N° of open torque faults       N° of thermal faults
  -  N° of closing operations       N° of powering
  -  N° of close torque faults
- With the selected data logging press the  key.
- As an example, if the Total running hours is 130012, it will display ""(blank),"13","00","12","""(blank),...
- Press the  key.
- In order to return to previous menu press the  key.

### 10.9.17 New Password

Procedure:

- Enter in the setting mode (chapter 10.9.1)
- Press the  or  key to select the Password menu .
- Press the  key.
- Use the  or  keys to scroll through the desired password 00-FF (hexadecimal).
- Press the  key.



**CAUTION: Password changing is a delicate operation. Write it down and keep it safety. In case of missing, contact CENTORK**

## 11 TROUBLE SHOOTING

The following instructions are offered for the most common difficulties encountered during installation and start-up.

### 11.1 Front panel indication fault

- **L1 and L3 yellow blinking:**
  - **Cause:** Limit switch failure. Both limit switches are activated or an opposite limit switch is activated during a CLOSE or OPEN operation.
  - **Solution:**
    - Check the limit switch setting (10.2 and 10.3 chapters) and SW4 setting (10.1.3 chapter).
    - Press **STOP** in centronik frontal panel (LOCAL mode) or **STOP** command (REMOTE mode) to reset the anomaly event (Anomaly acknowledgement).
- **L4 yellow blinking:**
  - **Cause:** Torque switch failure. An opposite limit switch is activated during a CLOSE or OPEN operation.
  - **Solution:** Check the SW4 setting (10.1.3 chapter).
- **L2 yellow:**
  - **Cause:** Movement fault. During a CLOSE or OPEN operation and after 7 seconds, if the state of the blinker transmitter does not change, the centronik unit activates the “blinker fault” alarm, and it is considered as “NO motion is detected”. Cause of the anomaly: Switching unit disengaged, valve stuck or motor damaged.
  - **Solution:**
    - Check the limit switch setting (10.2 and 10.3 chapters), and verify if switching and signalling gears (Pinions and wheels) move as actuator runs.
    - Check if the motor works correctly.
    - Check if actuator can be operated manually by means of the actuator handwheel.
    - Press **STOP** in centronik frontal panel (LOCAL mode) or **STOP** command (REMOTE mode) to reset the anomaly event (Anomaly acknowledgement).
- **L2 red or red blinking:**
  - **Cause:** Motor protection tripped. Duty service exceeds.
  - **Solution:**
    - Check that the valve is correctly lubricated. It must be ensured via the control that the duty service of the actuator is not exceeded. This can be achieved by setting the rest time (10.9.6 chapter) to a sufficiently high enough value and to increase the deadbands values (10.9.9 chapter).
    - Press **STOP** in centronik frontal panel (LOCAL mode) or **STOP** command (REMOTE mode) to reset the anomaly event (Anomaly acknowledgement).
- **L5 red:**
  - **Cause:** Lost Phase.
  - **Solution:**
    - Check if the 3 phases power supply is correct.
- **L5 yellow:**
  - **Cause:** Inverse phase connection. The Centronik unit includes a 3 phases correction system therefore this indication is not an alarm/fault. This is not an anomaly, it is a warning message. The centronik phase-sequence discriminator circuit will correct them automatically, but the LED will turn on in yellow colour.
  - **Solution:** Invert two phases; The yellow colour of LED5 will change to green colour.

- **L1, L2 and L3 yellow: Rest time executing (Chapter 10.9.6)**
- **L2 green: Stepping mode activated and OFF time executing (Chapter 10.9.15).**
- **All LEDs switch off:**
  - **Cause:** Power supply fault, fuse burned or display board disconnected.**Solution:** Check if the power supply is correct, fuses state and display board connection.

### **11.2 Actuator does not operate in LOCAL mode**

- Check front panel indication fault.
- Check SW1, SW2 and SW3 setting (Chapter 10.1.1).
- Check the connection (cable) between the front panel board and the CPU board, as depicted on 5.5 chapter)

### **11.3 Actuator does not operate correctly in REMOTE mode**

- Check front panel indication fault.
- Check SW8 setting (Chapter 10.1.5).
- In case of analogue input control (Modulating duty), check the correct connection, the SW6 setting (Chapter 10.1.4), and the setting procedure (Chapter 10.9). Check if ESD is not activated.
- In case of parallel control (ON/OFF duty and ON/OFF with display duty), check the correct connection. Check if ESD is not activated.

### **11.4 Actuator turn in the wrong sense**

- Check the SW4 setting (Chapter 10.1.2).

### **11.5 Centronik output signals does not work**

- Check the output signals setting (Chapter 10.9.5).
- Check the correct connection.

## 12 MAINTENANCE

**CAUTION: Safety instructions on chapter 2 must be observed.**

CENTORK actuators are supplied greased from the factory for their lifetime, needing practically no maintenance.

### 12.1 Commissioning, after the star-up

- Check for damage on paint caused by transport, assembly or handling and repair the damage carefully in order to ensure complete protection against corrosion.
- **Make sure that all the o-ring seals are correctly mounted and that the cable glands are firmly fastened, and protection plug for cable entry not used have been replaced with metallic protection plug sealed with PTFE tape, in order to ensure the IP67, IP68 protection.**
- Check that switching and signalling cover and connection cover screws are correctly fastened.
- **Check the correct tightening of the bolts between the actuator and the valve.**
- Check the correct greasing of the gear housing.
- The most important condition for reliable service of the CENTORK actuators is the fact of having carried out a correct commissioning and set-up procedure.

### 12.2 Maintenance for service

CENTORK recommends for a preventive maintenance programme. Approximately 3 months after commissioning and then every 9/12 months:

- **Check the correct tightening of the bolts between the actuator and the valve.**
- **Take advantage of each revision to check the proper tightening of the covers, of the handwheel lock and the external electric connection.**
- **Check cable entries.**
- **Visual inspection inside of switching and signalling, and electrical compartments.**
- Contact with valve manufacturer in order to know about maintenance routines of valve.
- In the event of infrequent service, perform a test run every 6 months in order to ensure the availability of service of the actuator.

### 12.3 Electric actuator's service life

- Electric actuator service life is rated to 20.000 cycles.
- Each cycle is formed by an opening manoeuvre (Valve close position to valve open position) and a closing manoeuvre (Valve open position to valve close position).
- 50 turns has been considered as standard valve stroke reference.



## 12.4 Fuse replacement

- The Centronik unit presents 2 fuses. In order to replace the fuses SAFETY INSTRUCTION must be observed (Chapter 2).
- With power off, open the electrical cover and the explosion proof cover.
- Open the fuse holders and replace the fuses according to the table below.

### Electric actuator with Terminals connection

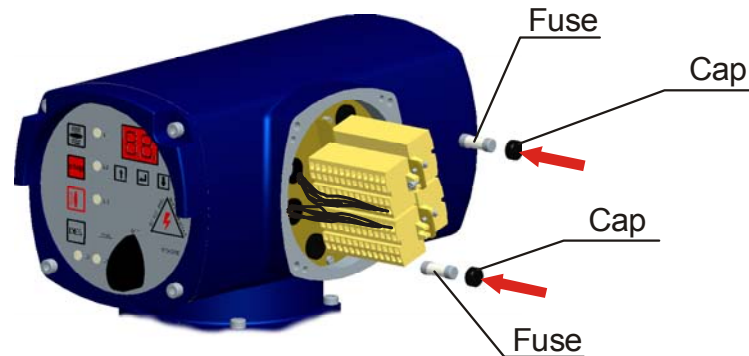

### Electric actuator with Plug-socket connectors with screws

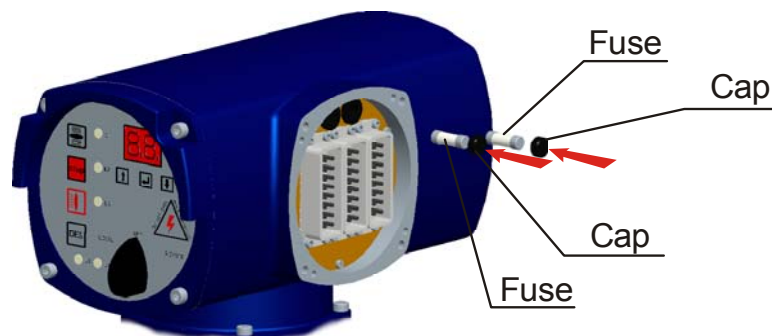

TENSION	CARACT. FUSE
24VDC	5A (5X20mm)
110/120VAC	2A (5X20mm)
220/230VAC	1A (5X20mm)

TENSION	CARACT. FUSE
380 to 440 VAC	500mA (6.3X32mm)
460 to 600 VAC	250mA (6.3X32mm)

- Once you have checked that the fuse holders have been properly carried out and the state of the o-ring seal, close the explosion proof cover. Fasten the 4 screws crosswise.
- Close the electrical cover and check the proper connection, the state of the o-ring seal and the proper installation of the latter, greasing it slightly. Fasten the 4 screws crosswise.

## 13 TECHNICAL SUPPORT

Each actuator is supplied with a datasheet on A4 format. The following is included:

- The nameplates attached to the actuator.
- Electric actuator datasheet.
- The electric connection diagram for each actuator (also stuck inside the connections cover of the actuator).
- This electric actuator user manual.

For any claim or information request, the SERIAL NUMBER included on this datasheet or on the Electric actuator nameplates should be used.

Electric actuator manufacturer address: See on Manual covers.

## 14 LIST OF SPARE PARTS

### 14.1 Actuator unit

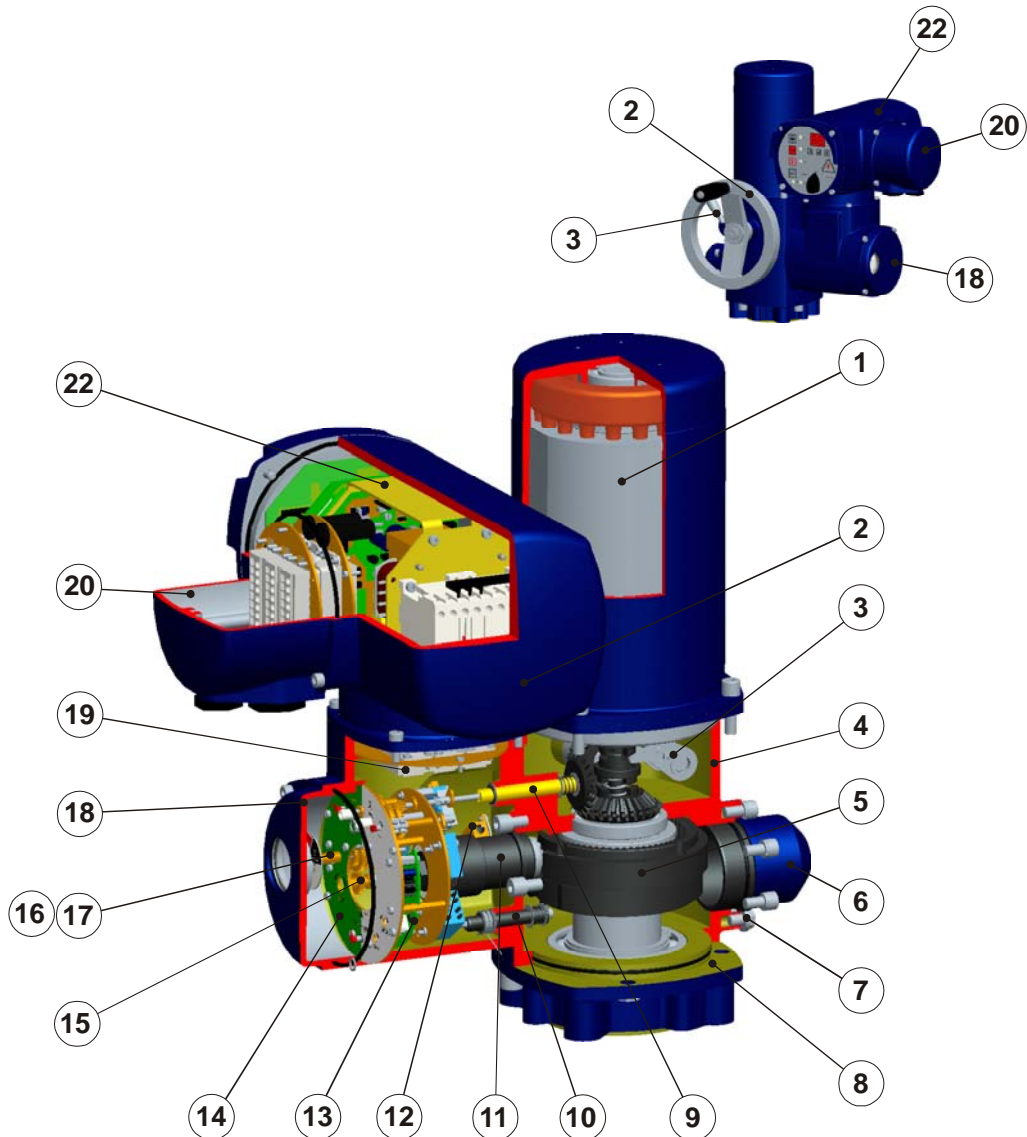

<i>Electric actuators with centronik, 400 series</i>					
Mark	Description	QTY	Mark	Description	QTY
1	Electric motor	1	12	Heater	1
2	Handwheel and manual shaft subassembly	1	13	TPS electronic position transmitter	1
3	Override and declutch lever subassembly	1	14	Switching and signalling unit	1
4	Housing	1	15	Potentiometer subassembly	1
5	PTCS planetary subassembly	1	16	Gearing unit subassembly	1
6	Energy absorber springs subassembly	1	17	Visual indicator subassembly	1
7	External ground earth terminal	1	18	Switching and signalling unit cover	1
8	Actuator output flange	1	19	Plug and socket connectors with limit and torque switches	1
9	Motion measuring shaft subassembly	1	20	Electric cover	1
10	Torque switching shaft subassembly	1	21	User connection (Plug and socket)	1
11	Torque regulator subassembly	1	22	Centronik unit	1

## 14.2 Centronik unit

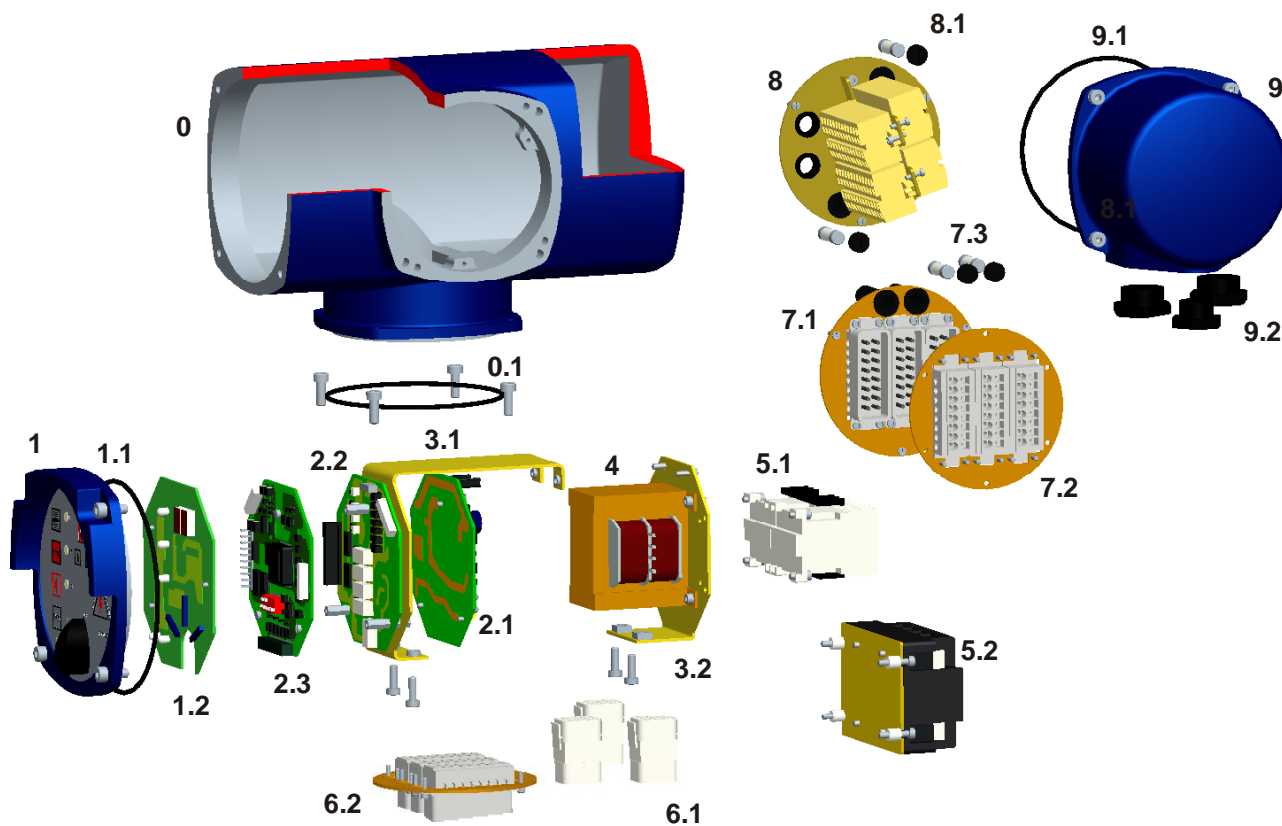

Mark	DESCRIPTION	Mark	DESCRIPTION
0	CENTRONIK MAIN CASE (ENCLOSURE)	5.2	SOLID STATE MOTOR STARTER: TYRISTOR (OPTIONAL)
0.1	O-RING	6.1	INTERNAL CONNECTION (AERIAL)
1	CENTRONIK FRONTAL PANEL	6.2	INTERNAL CONNECTION (PLUG AND SOCKET)
1.1	O-RING	7.1	USER CONNECTION (PLUG AND SOCKET -MALE-)
1.2	ELECTRONIC BOARD (KEYBOARD AND DISPLAY)	7.2	USER CONNECTION (PLUG AND SOCKET -FEMALE-)
2.1	ELECTRONIC BOARD (CPU)	7.3	FUSES
2.2	ELECTRONIC BOARD (I/O)	8.1	USER CONNECTION (TERMINALS)
2.3	ELECTRONIC BOARD (POWER)	8.2	FUSES
3.1	ELECTRONIC SUPPORT	9	ELECTRIC COVER
3.2	TRANSF. AND CONTACTOR SUPPORT	9.1	O-RING
4	TRANSFORMER	9.2	CABLE ENTRIES PROTECTION PLUGS
5.1	CONTACTOR (STARTER)		

## APPENDIX: OUTPUT TYPES

### OUTPUT TYPE A Size F-07 (ISO 5210)

Disassembly:

- Employing a suitable tool, remove the retaining ring (3), which fixes the removable bronze bush (1).
- Push in order to extract this piece.

Assembly:

- Having machined the removable bush according to valve stem dimensions, refit the drive bus (1) into the output shaft bore, align the keyway (2) in its output shaft shape.
- Refit the retaining ring (3).

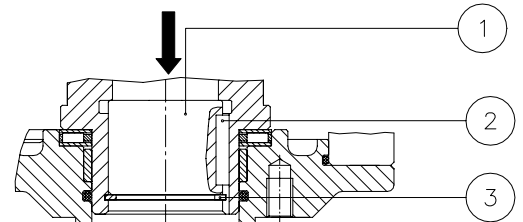

**Figure 1**

### OUTPUT TYPE A Size F-10/F-16/F-25 (ISO 5210)

Disassembly:

- Push and press the removable bronze bush (2) in order to extract the cover (4), axial bearings (3) and removable bronze bush (2)

Assembly:

- Having machined the removable bronze bush according to valve shaft, clean thoroughly this piece. Apply grease on axial bearings and discs (3). Assemble axial disc on removable bush (2), finally insert the cover (4). Check O-rings on cover.
- Apply grease on. Insert the removable bush on output type A base casting unit and output shaft, notice that dog coupling (Tooth) on bushing should match with actuator hollow output shaft (1). Verify O-ring (4).
- For maintenance, grease can be supply thought grease nipple (5).

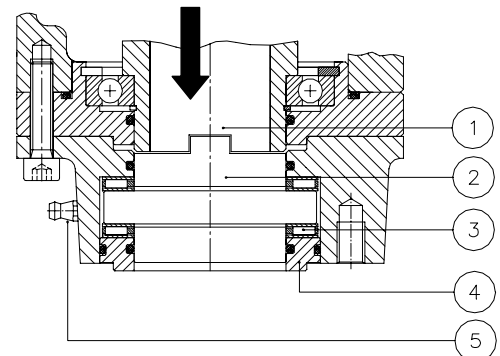

**Figure 2**

### OUTPUT TYPE A Size F-14 (ISO 5210)

Disassembly:

- Remove retaining ring (5) and unscrew the stop ring (4) employing a suitable tool.
- Push and press the removable bronze bush (1) in order to extract it.

Assembly:

- Having machined the removable bush according to valve stem dimensions, refit the drive bus (1) into the output shaft bore (3), align the keyway (2) in its output shaft shape.
- Screw the stop ring (4) employing a suitable tool.

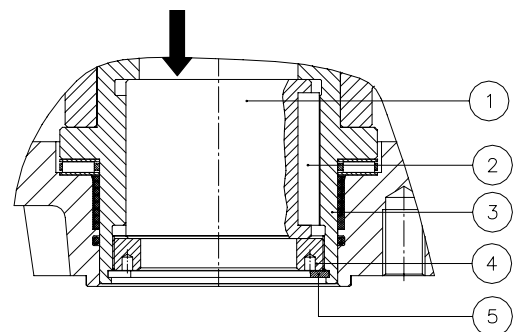

**Figure 3**

- Refit the retaining ring (5).

**OUTPUT TYPE B3 Size F-07/F-10/F-14/F-16/F-25  
(ISO 5210)**

Disassembly:

- Employing a suitable tool, remove the retaining ring (4), which fixes the removable steel bush (1).
- Push in order to extract this piece.

Assembly:

- Having machined the removable steel bush according to valve stem dimensions, refit the drive bus (1) into the output shaft bore, align the keyway (2) in its output shaft shape.
- Refit the retaining ring (4).

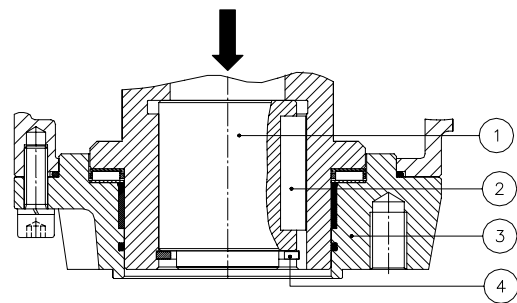

**Figure 4**

**OUTPUT TYPE B0 Size F-10 / F-14**

B0 output type is supplied, already machined, according to dimensions published in technical datasheets.

Disassembly:

- Employing a suitable tool, remove the retaining ring (3), which fixes the removable steel bush (1). Removable bush is located inside of output shaft (2)
- Push in order to extract this piece.

Assembly:

- Having machined the removable steel bush according to valve stem dimensions, refit the drive bus (1) into the output shaft bore.
- Refit the retaining ring (3).

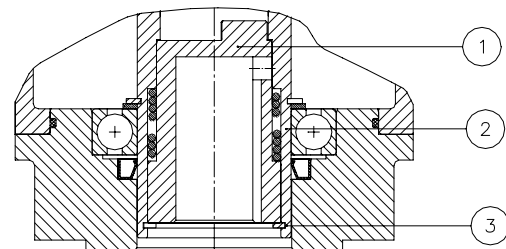



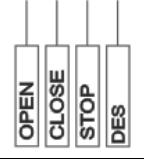

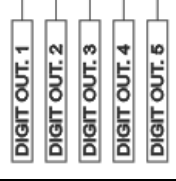
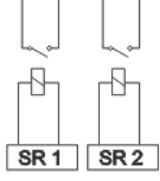

**Figure 5**

### FASTEN BOLTS (CLASS 8.8)



BOLT	FRICTION FACTOR		
	LOW	MEDIUM	HIGH
<b>M4</b>	4.2	6	8
<b>M6</b>	6.2	8.2	10
<b>M8</b>	15	21	24
<b>M10</b>	30	41	48
<b>M12</b>	49	68	85
<b>M14</b>	85	108	130
<b>M16</b>	130	165	200
<b>M18</b>	170	240	280
<b>M20</b>	240	340	410
<b>M30</b>	800	1150	1350
<b>M36</b>	1450	2050	2400

Torque values in N.m  
Steel bolts class 8.8

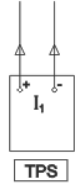
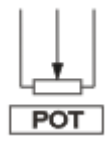
## WIRING DIAGRAMS, TERMINAL PLANS, LEGENDS AND SYMBOLS

SYMBOL	DESCRIPTION	TECHNICAL FEATURES
	<p><u>M1</u> Main power supply (single and three-phase)</p>	<p>Main power supply: See Centronik nameplates Main voltage supply tolerance: <math>\pm 10\%</math> Frequency tolerance: <math>\pm 5\%</math></p>
	<p><u>M1</u> Main power supply (DC)</p>	<p>Main power supply: See Centronik nameplates Main voltage supply tolerance: <math>\pm 20\%</math></p>
	<p><u>Remote inputs</u> OPEN, CLOSE, STOP (ALARM RESET), UNLOCK remote input signal</p>	
	<p><u>ESD</u> Emergency Shut Down remote input signal</p>	
	<p><u>Digital outputs</u> Centronik output signals 24 VDC digital outputs</p>	<p>Programmable digital outputs 24VDC, 100mA max. Setting: ON-OFF duty, see 10.1.2 chapter. MODULATING and ON-OFF with display duty, see 10.9.5 chapter</p>
	<p><u>SR1, SR2...SR5</u> Centronik output signals Relay outputs</p>	<p>Programmable relay outputs SR1 to SR4: 250VAC/24VDC, 5A max. SR5: 250VAC/24VDC, 2A max.</p>
	<p><u>POSIT./COMMON P.</u> Control input</p>	<p>Analogue input 0/4-20mA or 0/5V (0/10V as option) Resistance value: 220<math>\Omega</math>  See 6.1.1.2 chapter</p>
	<p><u>TPS</u> 0/4-20mA position transmitter</p>	<p>2 wires: 0/4-20mA Maximum resistance: 600 Ohms Precision: &lt;1%  Setting: See 10.8 chapter</p>
	<p><u>POT</u> Precision Potentiometer</p>	<p>10 kOhms (other values on request) Ohmic value tolerance: <math>\pm 20\%</math> std. (<math>\pm 10\%</math> optional) Linearity: &lt;1% Power: 1W max. Turning angle: 340<math>^\circ \pm 5\%</math> Life: 10<sup>5</sup> cycles See 10.7 chapter</p>

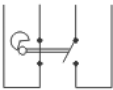
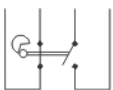
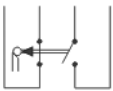

 <b>FPC 2</b>	<p><u>FPC</u> CLOSE torque microswitch</p>	<p>Microswitch with silver contacts Type of contact: 1 NO / 1 NC Protection degree: IP67 Contacts: Two fast acting Mech. life: <math>5 \cdot 10^6</math> Electr. life: <math>5 \cdot 10^6</math> Microswitch circuits NO+NC contacts, only the same potential can be connected through both circuits. For different potentials, two double Microswitches must be used</p> <table border="1" data-bbox="786 551 1353 665"> <tr> <td rowspan="2">Silver contacts</td> <td colspan="3">AC</td> <td colspan="3">DC</td> </tr> <tr> <td>30V</td> <td>125V</td> <td>250V</td> <td>30V</td> <td>125V</td> <td>250V</td> </tr> <tr> <td>Max. load</td> <td>8A</td> <td>6A</td> <td>5A</td> <td>2A</td> <td>0.6A</td> <td>0.4A</td> </tr> </table>	Silver contacts	AC			DC			30V	125V	250V	30V	125V	250V	Max. load	8A	6A	5A	2A	0.6A	0.4A
Silver contacts	AC			DC																		
	30V		125V	250V	30V	125V	250V															
Max. load	8A		6A	5A	2A	0.6A	0.4A															
 <b>FPA 2</b>	<p><u>FPA</u> OPEN torque microswitch</p>																					
 <b>FRC 2</b>	<p><u>FRC</u> CLOSE limit microswitch. (CLOSE end position)</p>																					
 <b>FRA 2</b>	<p><u>FRA</u> OPEN limit microswitch. (OPEN end position)</p>																					
 <b>AUX 1</b>	<p><u>AUX1</u> Auxiliary switches for middle-valve positions</p>	<p>Microswitch with silver contacts Type of contact: 1 NO (SPDT) Protection degree: IP67 Contacts: One fast acting Mech. life: <math>3 \cdot 10^7</math> Electr. life: <math>3 \cdot 10^7</math></p> <table border="1" data-bbox="786 967 1353 1070"> <tr> <td rowspan="2">Silver contacts</td> <td colspan="3">AC</td> <td colspan="3">DC</td> </tr> <tr> <td>30V</td> <td>125V</td> <td>250V</td> <td>30V</td> <td>125V</td> <td>250V</td> </tr> <tr> <td>Max.load</td> <td>4A</td> <td>4A</td> <td>4A</td> <td>2A</td> <td>0.6A</td> <td>0.4A</td> </tr> </table>	Silver contacts	AC			DC			30V	125V	250V	30V	125V	250V	Max.load	4A	4A	4A	2A	0.6A	0.4A
Silver contacts	AC			DC																		
	30V	125V	250V	30V	125V	250V																
Max.load	4A	4A	4A	2A	0.6A	0.4A																

**For further technical information, consult CENTORK technical datasheet or contact directly with CENTORK. CENTORK address can be found printed on manual covers.**

Others wiring diagrams are available and are included with each actuator provided.



## DECLARATION OF CONFORMITY

CENTORK VALVE CONTROL S.L. hereby declares under sole responsibility that the electric actuators, series listed below

**1400. 1401. 1402. 1403. 1404. 1405. 1460. 1461. 1462. 1603. 1464. 1465.  
1410. 1411. 1412. 1413. 1414. 1415. 1470. 1471. 1472. 1473. 1474. 1475**

are designed and produced to be installed on industrial valves in compliance with the essential safety requirements of the following directives

*89/336/EC directive: Electromagnetic compatibility  
73/23/EC directive: Low-voltage equipment  
98/37/EC directive: Mechanical equipment-Machinery.*

Compliance with the Essential health and Safety Requirements has been assured by compliance with:

*ISO 5210: 1.991  
ISO 5211: 2.001  
EN 292-1: 1.993  
EN 292-2: 1.993*

*EN 50081-2:1994  
EN 50082-2:1998  
EN 61000-4:1999  
EN 60204-1: 1.999*

*EN60034-1: 1.998  
EN50178: 1.998  
DIN VDE 0100: 1.997  
DIN VDE 0530: 1982*

Centork actuators covered by this Declaration must not be put into service until the equipment into which they are incorporated, has been declared in conformity with the provisions of the Machinery Directive.

Lezo, 21 de Enero de 2.008



Francisco Lazcano  
-General manager-

(Centro fabricación y sede social)  
**Centork Valve Control S.L.**  
Pol ind. 110 Txatxamendi 24-26  
Lezo 20.100 SPAIN

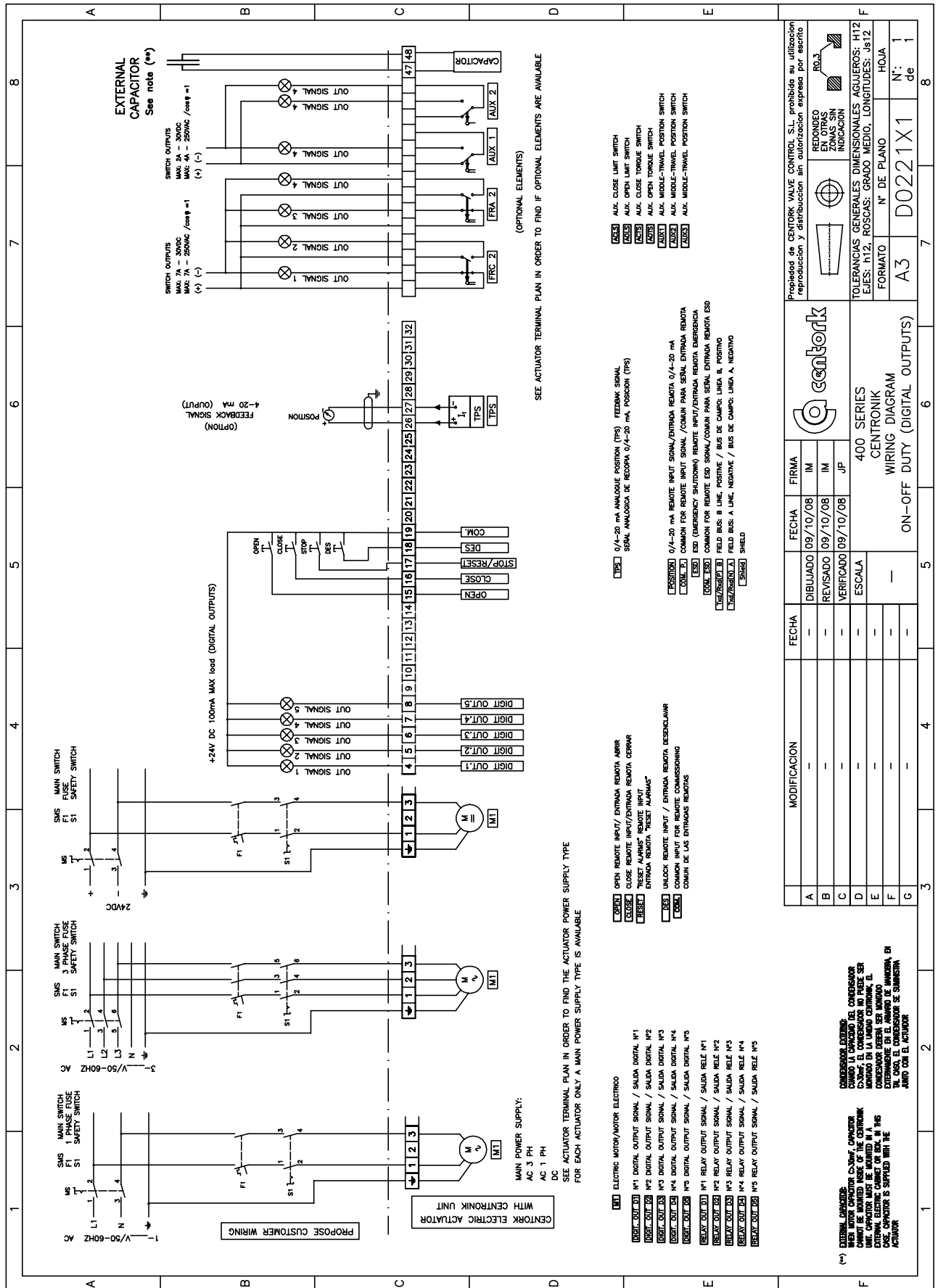

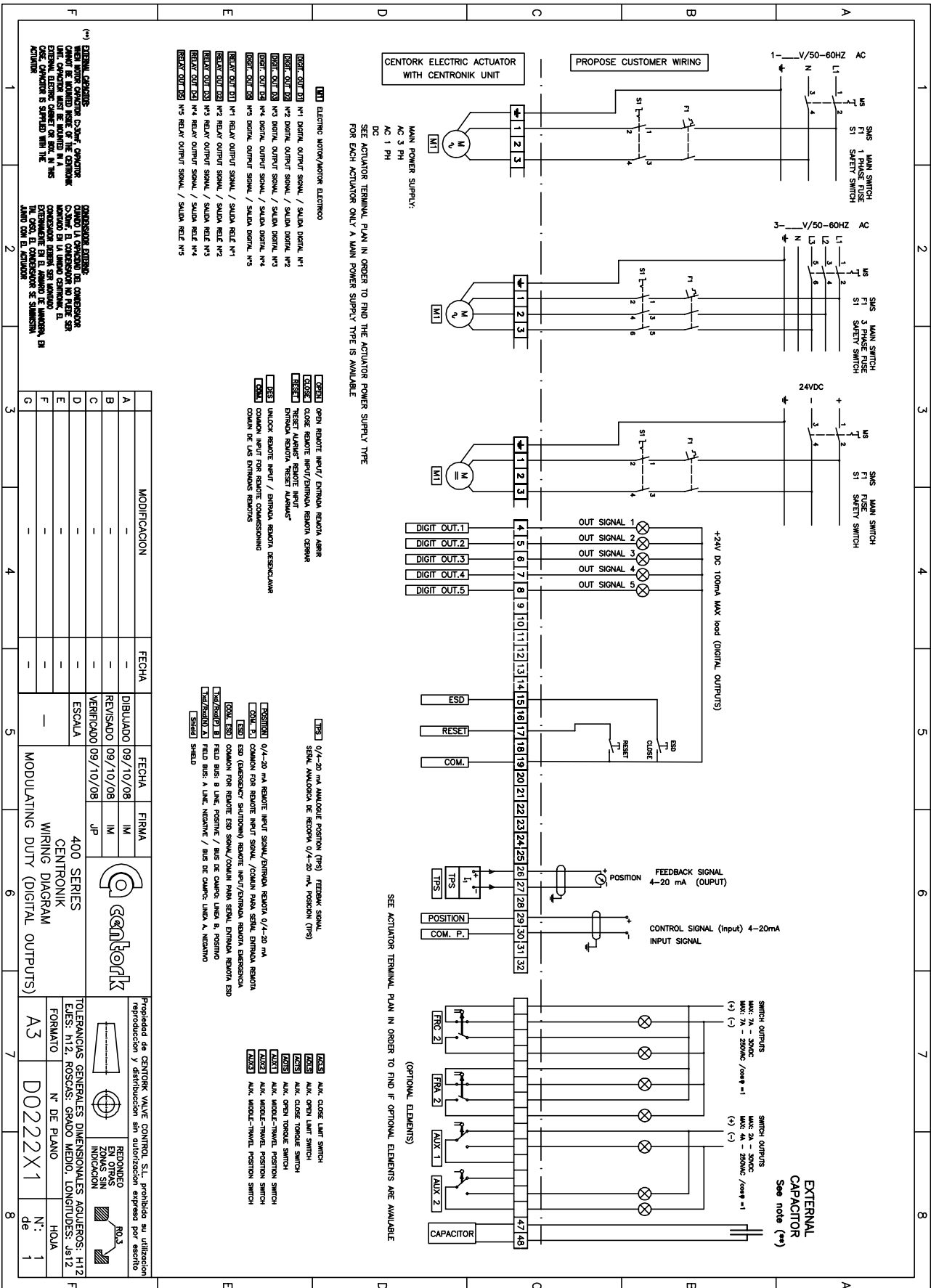

**[M1]** ELECTRIC MOTOR/MOTOR ELECTRONICO  
**[M2]** DIGITAL OUTPUT SIGNAL / SALIDA DIGITA. N°1  
**[M3]** DIGITAL OUTPUT SIGNAL / SALIDA DIGITA. N°2  
**[M4]** DIGITAL OUTPUT SIGNAL / SALIDA DIGITA. N°3  
**[M5]** DIGITAL OUTPUT SIGNAL / SALIDA DIGITA. N°4  
**[M6]** DIGITAL OUTPUT SIGNAL / SALIDA DIGITA. N°5  
**[M7]** DIGITAL OUTPUT SIGNAL / SALIDA DIGITA. N°6  
**[M8]** DIGITAL OUTPUT SIGNAL / SALIDA DIGITA. N°7  
**[M9]** DIGITAL OUTPUT SIGNAL / SALIDA DIGITA. N°8  
**[M10]** DIGITAL OUTPUT SIGNAL / SALIDA DIGITA. N°9  
**[M11]** DIGITAL OUTPUT SIGNAL / SALIDA DIGITA. N°10  
**[M12]** DIGITAL OUTPUT SIGNAL / SALIDA DIGITA. N°11  
**[M13]** DIGITAL OUTPUT SIGNAL / SALIDA DIGITA. N°12  
**[M14]** DIGITAL OUTPUT SIGNAL / SALIDA DIGITA. N°13  
**[M15]** DIGITAL OUTPUT SIGNAL / SALIDA DIGITA. N°14  
**[M16]** DIGITAL OUTPUT SIGNAL / SALIDA DIGITA. N°15

**[OPEN]** OPEN REMOTE INPUT / ENTRADA REMOTA ABRIR  
**[CLOSE]** CLOSE REMOTE INPUT / ENTRADA REMOTA CERRAR  
**[RESET]** RESET REMOTE INPUT / ENTRADA REMOTA REINICIO  
**[REVERSE]** REVERSE REMOTE INPUT / ENTRADA REMOTA INVERSIÓN  
**[DESBLOCK]** UNLOCK REMOTE INPUT / ENTRADA REMOTA DESBLOQUEO  
**[COMAND]** COMMON INPUT FOR REMOTE COMMANDS / COMANDO DE LAS ENTRADAS REMOTAS  
**[TSS1]** 0/1-20 mA ANALOGUE POSITION (TPS) / PREENSAL SIGNAL / SEÑAL ANALÓGICA DE POSICIÓN (TPS)  
**[TSS2]** 0/1-20 mA ANALOGUE POSITION (TPS) / PREENSAL SIGNAL / SEÑAL ANALÓGICA DE POSICIÓN (TPS)  
**[COM1]** COMMON FOR REMOTE INPUT SIGNAL / COMANDA PARA SEÑAL ENTRADA REMOTA  
**[COM2]** COMMON FOR REMOTE INPUT SIGNAL / COMANDA PARA SEÑAL ENTRADA REMOTA  
**[COM3]** COMMON FOR REMOTE INPUT SIGNAL / COMANDA PARA SEÑAL ENTRADA REMOTA  
**[COM4]** COMMON FOR REMOTE INPUT SIGNAL / COMANDA PARA SEÑAL ENTRADA REMOTA  
**[COM5]** COMMON FOR REMOTE INPUT SIGNAL / COMANDA PARA SEÑAL ENTRADA REMOTA  
**[COM6]** COMMON FOR REMOTE INPUT SIGNAL / COMANDA PARA SEÑAL ENTRADA REMOTA  
**[COM7]** COMMON FOR REMOTE INPUT SIGNAL / COMANDA PARA SEÑAL ENTRADA REMOTA  
**[COM8]** COMMON FOR REMOTE INPUT SIGNAL / COMANDA PARA SEÑAL ENTRADA REMOTA  
**[COM9]** COMMON FOR REMOTE INPUT SIGNAL / COMANDA PARA SEÑAL ENTRADA REMOTA  
**[COM10]** COMMON FOR REMOTE INPUT SIGNAL / COMANDA PARA SEÑAL ENTRADA REMOTA  
**[COM11]** COMMON FOR REMOTE INPUT SIGNAL / COMANDA PARA SEÑAL ENTRADA REMOTA  
**[COM12]** COMMON FOR REMOTE INPUT SIGNAL / COMANDA PARA SEÑAL ENTRADA REMOTA  
**[COM13]** COMMON FOR REMOTE INPUT SIGNAL / COMANDA PARA SEÑAL ENTRADA REMOTA  
**[COM14]** COMMON FOR REMOTE INPUT SIGNAL / COMANDA PARA SEÑAL ENTRADA REMOTA  
**[COM15]** COMMON FOR REMOTE INPUT SIGNAL / COMANDA PARA SEÑAL ENTRADA REMOTA

**[L1]** AUX. CLOSE LIMIT SWITCH  
**[L2]** AUX. OPEN LIMIT SWITCH  
**[L3]** AUX. OPEN TORQUE SWITCH  
**[L4]** AUX. CLOSE TORQUE SWITCH  
**[L5]** AUX. DOUBLE-TRAVEL POSITION SWITCH  
**[L6]** AUX. SINGLE-TRAVEL POSITION SWITCH  
**[L7]** AUX. DOUBLE-TRAVEL POSITION SWITCH  
**[L8]** AUX. SINGLE-TRAVEL POSITION SWITCH  
**[L9]** AUX. DOUBLE-TRAVEL POSITION SWITCH  
**[L10]** AUX. SINGLE-TRAVEL POSITION SWITCH  
**[L11]** AUX. DOUBLE-TRAVEL POSITION SWITCH  
**[L12]** AUX. SINGLE-TRAVEL POSITION SWITCH  
**[L13]** AUX. DOUBLE-TRAVEL POSITION SWITCH  
**[L14]** AUX. SINGLE-TRAVEL POSITION SWITCH  
**[L15]** AUX. DOUBLE-TRAVEL POSITION SWITCH  
**[L16]** AUX. SINGLE-TRAVEL POSITION SWITCH  
**[L17]** AUX. DOUBLE-TRAVEL POSITION SWITCH  
**[L18]** AUX. SINGLE-TRAVEL POSITION SWITCH  
**[L19]** AUX. DOUBLE-TRAVEL POSITION SWITCH  
**[L20]** AUX. SINGLE-TRAVEL POSITION SWITCH

MODIFICACION	FECHA	FECHA	FIRMA
A	-	09/10/08	IM
B	-	09/10/08	IM
C	-	09/10/08	JP
D	-	-	-
E	-	-	-
F	-	-	-
G	-	-	-

DIBUJADO	09/10/08	IM	
REVISADO	09/10/08	IM	
VERIFICADO	09/10/08	JP	400 SERIES CENTRONIK WIRING DIAGRAM
ESCALA	-	-	
MODULATING DUTY (DIGITAL OUTPUTS)			

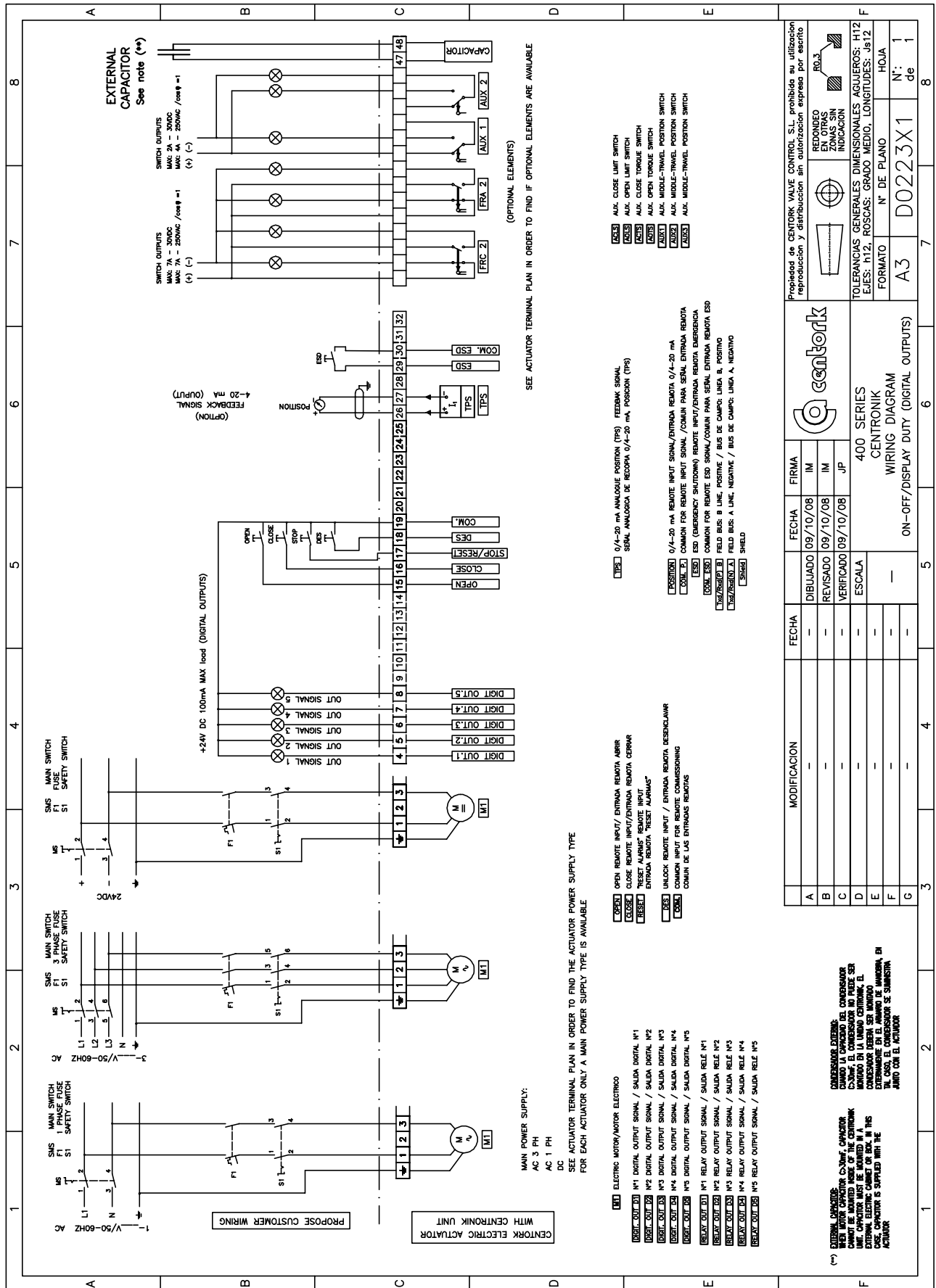

MODIFICACION		FECHA	FECHA	FIRMA
A	-	-	09/10/08	IM
B	-	-	09/10/08	IM
C	-	-	09/10/08	JP
D	-	-	-	ESCALA
E	-	-	-	-
F	-	-	-	-
G	-	-	-	-

  

		<b>400 SERIES</b> CENTRONIK WIRING DIAGRAM	
TOLERANCIAS GENERALES: DIMENSIONALES: AGUJEROS: H12 EJES: h12. ROSCAS: GRADO MEDIO. LONGITUDES: Js12		REDONDEO R0,3 ZONAS SIN INDICACION	
FORMATO N° DE PLANO	N° de HOJA	A3 D0223X1 N°: 1 de 1	

Propiedad de CENTORK VALVE CONTROL S.L. prohibida su utilización  
reproducción y distribución sin autorización expreso por escrito

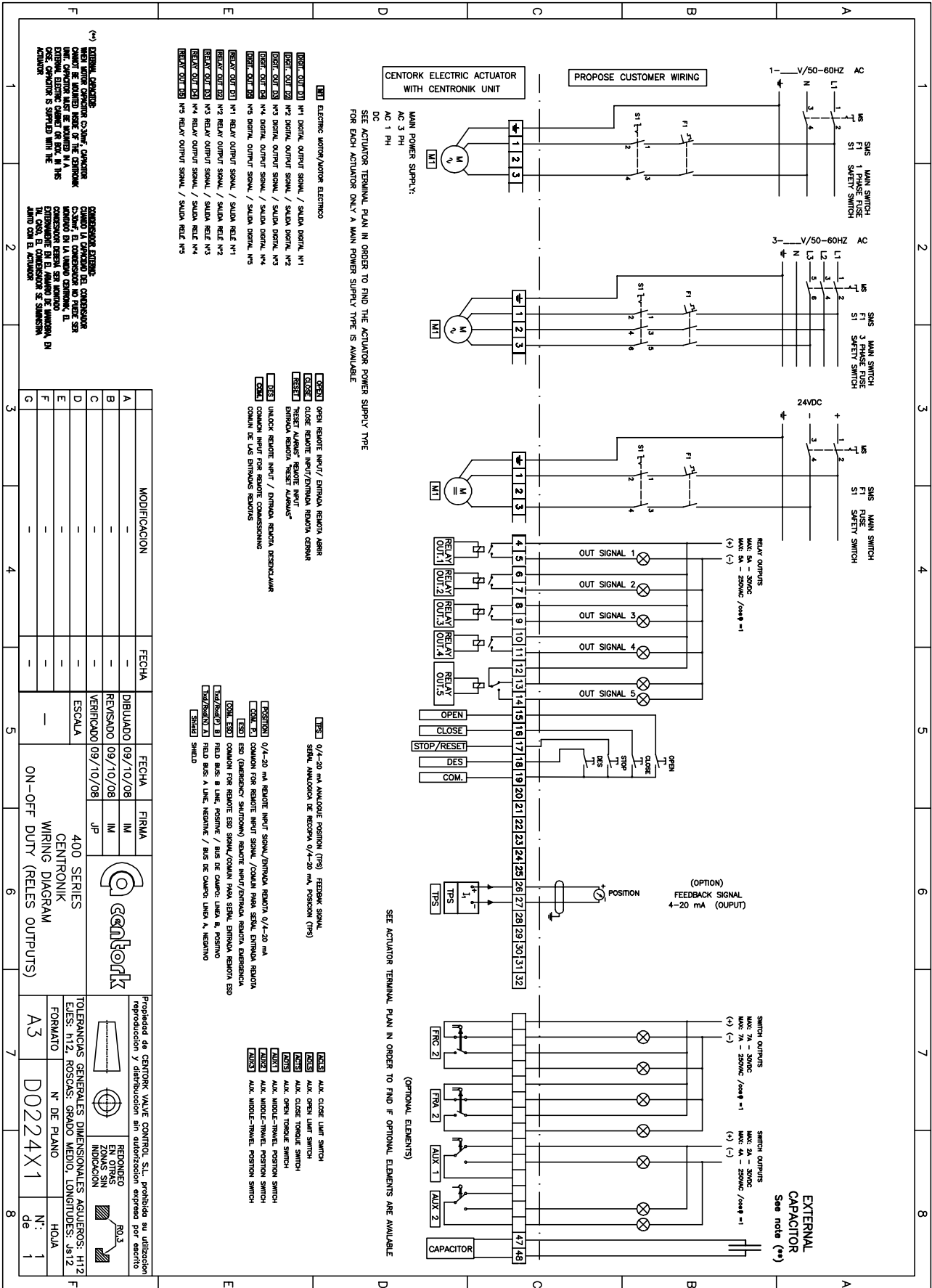

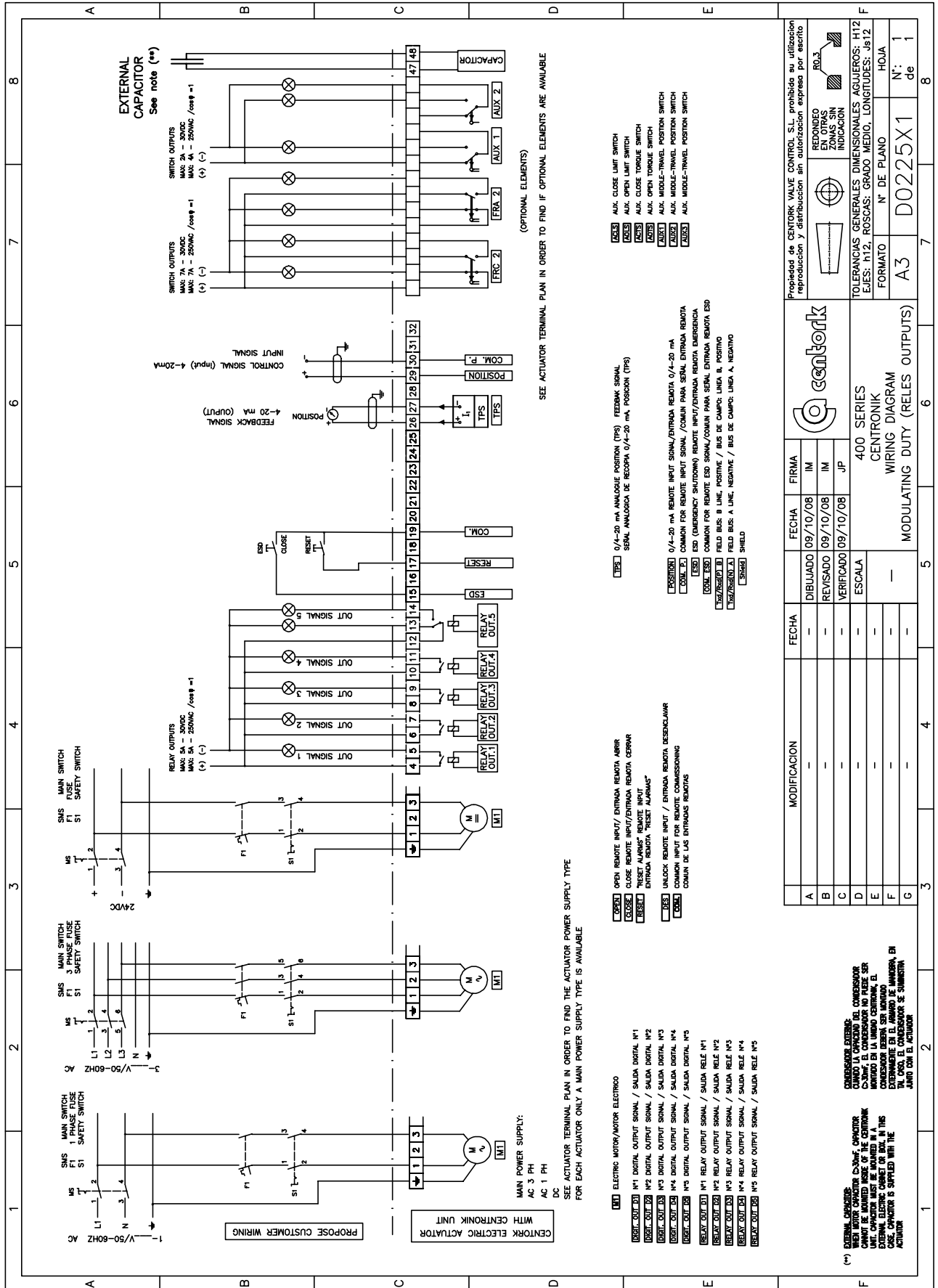

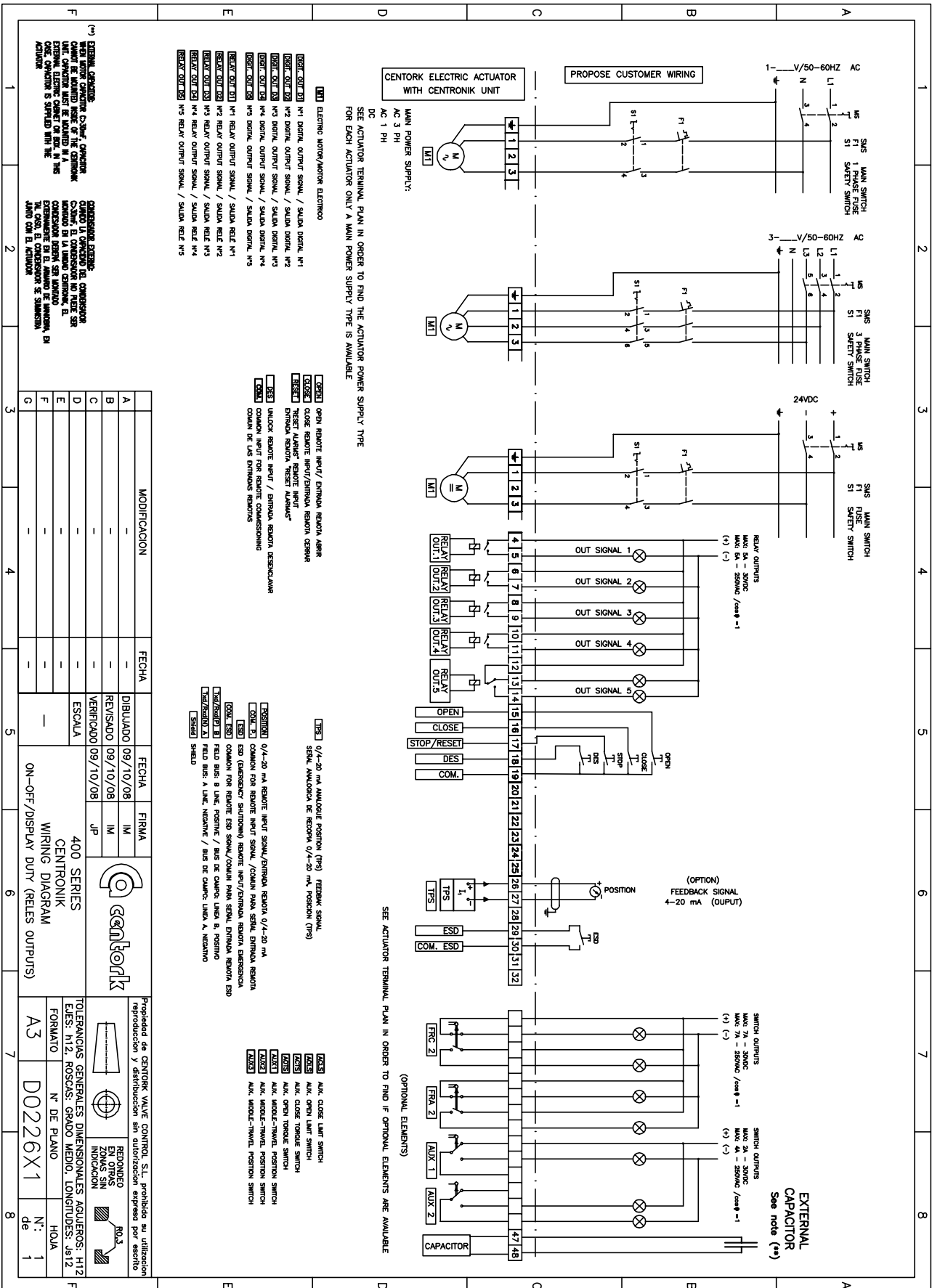







## **CENTORK Valve Control S.L.**

Pol. Ind. 110 , Txatxamendi 24-26  
Telf.: +34.943.31.61.36  
Email: [actuator@centork.com](mailto:actuator@centork.com)

LEZO 20.100 (SPAIN)  
Fax:: +34.943.22.36.57  
<http://www.centork.com>

**1497MANE1402X001**

**Edition: 12.09**